

OCTANORM PRODUCT CATALOGUE SYSTEM COMPONENTS

Discover the new aesthetic of OCTANORM



INNOVATION
INFORMATION
INSPIRATION





ARTICLE CODES

.00	raw / unfinished
MATT ANODIZED FINISHES	
.01	matt anodized, silver (E6/EV1)
.02	matt anodized, bronze (E6/3175)
.03	matt anodized, black (E6/3180)
.04	matt anodized, gold (E6/EV3)
.08	matt anodized, special color
POLISHED ANODIZED FINISHES	
.10	polished, anodized, gold (ES Version)
.11	polished, anodized, silver (E2/EV1, E4/EV1)
.12	polished, anodized, silver (ES Version)
.13	polished, anodized, black (ES Version)
.14	polished, anodized, gold (E4/EV3)
.15	polished, anodized, bronze (ES Version)
.16	polished (UK Version), anodized silver
.17	polished (UK Version), anodized gold
.18	polished, anodized, special color
.19	polished, anodized, stainless steel optics
POWDER COATED FINISHES	
.20	white powder-coated (RAL 9010/IG-94750-54 or TI-1910061)
.21	silver powder-coated (RAL 9006/IG-54.9006-54)
.22	bronze powder-coated (SOF 10262-98) to match .02
.23	black powder-coated (RAL 9005/IG-9005-56)
.24	black powder-coated (RAL 9011)
.25	white powder coated (RAL 9016)
.26	white powder coated (RAL 9001)
.27	white powder coated (RAL 9002)
.28	satin finish RAL (polish grade 70-80) standard
.29	polished RAL (polish grade 90)
AS PER MANUFACTURE	
.30	white
.31	silver-grey
.32	brown
.33	black
.35	light grey
.36	grey
.37	zinc-plated
.38	nickel-plated
.39	matt chrome-plated
.40	matt gold-plated
.41	polished chrome-plated
.42	polished gold-plated
.43	carbon steel
.44	stainless steel
.50	translucent
.51	transparent
.60	wood finish
COIL COATED FINISHES	
.70	Coil-coated (RAL 9010)
.71	Coil-coated (RAL 9006)
.75	Coil-coated (RAL 9016)
.76	Coil-coated (RAL 9001)
.77	Coil-coated (RAL 9002)
.78	Coil-coated RAL
.80	white powder-coated (RAL 9010 matt, polish grade 30)
.85	white powder-coated (RAL 9016 matt, polish grade 30)
.88	matt RAL (polish grade 30)
.90	as catalogue description
.99	as order description



DON'T LEAVE YOUR SUCCESS TO CHANCE. BUILD IT WITH THE INGENUOUS PRODUCTS OF THE OCTANORM WORLD OF SYSTEMS!

For the most difficult technical challenges OCTANORM is providing contractors system based solutions for creative designs.



Special lengths, special radii, special surfaces and special colors are available on request

Special profiles, with corresponding special accessories, on request

Cutting and finishing services on request

Tools for the processing of the various components are listed in the tools section

Packing units of the individual components are included in the price list

The current product range can be viewed at www.octanorm.com
Product range training is available on request

We recommend the OCTANORM software programs OCTAdesign, OCTAcad and OCTAplano as planning and project tools.
On the internet, in-depth information on these software programs is available in the Service section.

The key word index and the item no. index are available as additional search criteria.

Detailed technical information can be viewed at www.octanorm.com/Pages/Search2.aspx



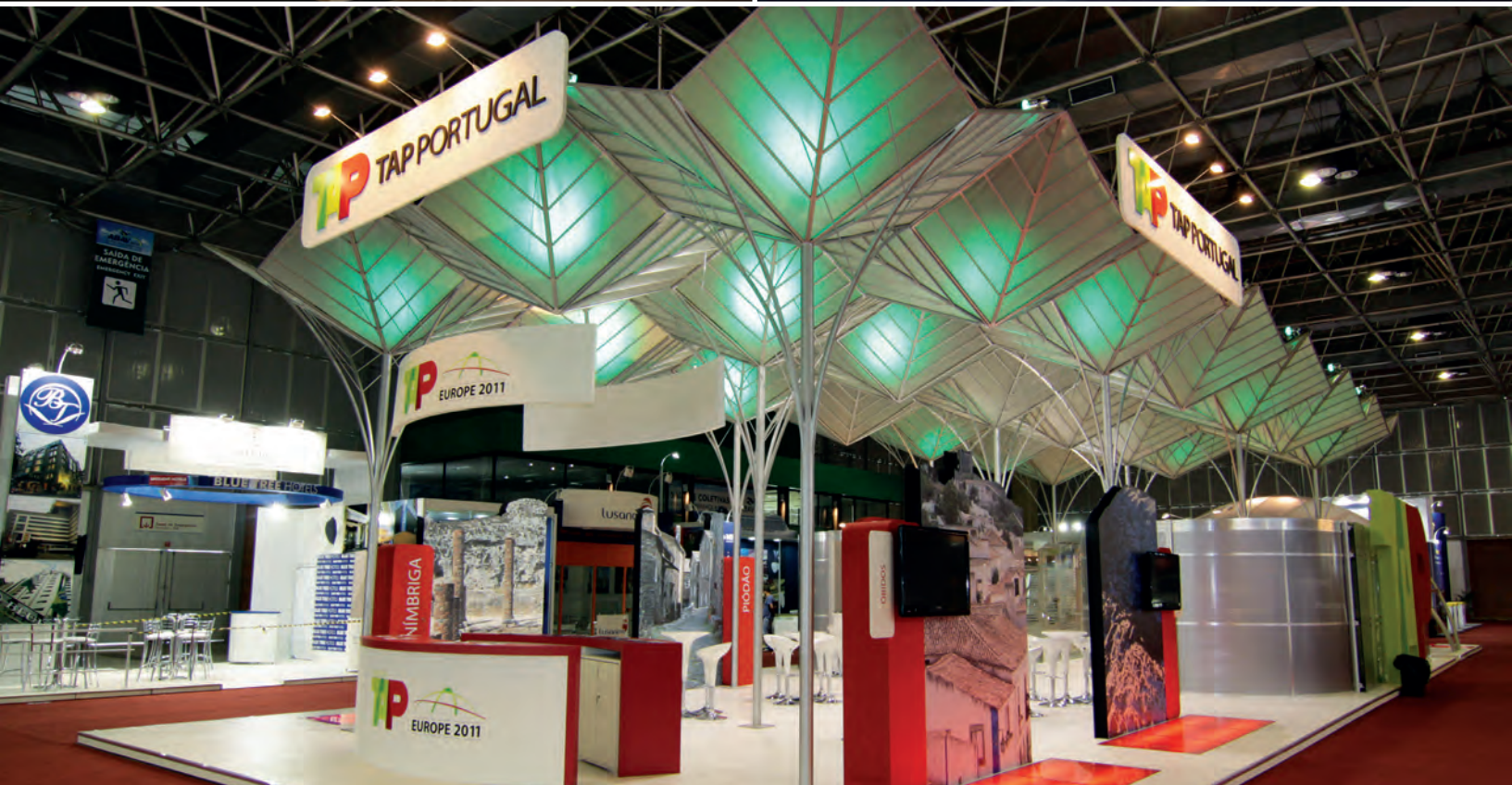

M 1000 M 1001 M 1002 M 1003 M 1005 M 1007 S 208 S 380		M 1015 M 1014	M 1016	320 x 120 M 1408	S 100		S 132	S 140	Ø 335 (M10) S 150 Ø 450 (M10) S 141
M 1010 M 1011		M 1065	M 1067	300 x 300 M 1407	S 108		S 132	S 140	S 137/K Ø 335 (M10) S 150
M 1012 M 1013 M 1020 M 1021 M 1018 M 1019 M 1022 M 1023 M 1058 M 1059		M 1035 M 1034	M 1038	300 x 300 M 1406 300 x 300 M 1416	S 201		S 230	S 240	Ø 450 (M10) S 141
M 225 M 226 M 227 M 230 M 232 M 1040 M 1041		M 1035 M 1034	M 1038	300 x 300 M 1416 450 x 450 M 1426 Ø 455 M 825	M 1201 M 1202 M 1204		M 1215	S 137/K M 1216	Ø 335 (M10) S 150 Ø 450 (M10) S 141
M 1082		M 1099			M 1210		M 1231	M 1232	Ø 335 M 1242 300 x 300 M 1407
M 1025 M 1026 M 1091 M 1092		M 274	M 285	450 x 450 M 1426 Ø 455 M 825	M 1220 M 1222		M 1235	M 1234	300 x 300 M 1406 Ø 335 M 1240 Ø 400 M 1239
M 1800 M 1810		M 1085	M 1086	320 x 120 M 1408	M 1220 M 1222		M 1235	M 1234	Ø 455 M 1238
M 1030		M 1087	M 1088	320 x 120 M 1408	M 235 M 236 M 237				450 x 450 M 1426
M 1052		M 1085	M 1086	320 x 120 M 1408	M 245		M 270	M 282	Ø 455 M 825
M 1009		M 1097	M 1098	320 x 120 M 1408	M 205 M 206 M 207				
M 1070		M 1087	M 1088	320 x 120 M 1408	M 205 M 206 M 207				
M 1070		M 1095	M 1096		M 215 M 216 M 217		M 270		Ø 455 M 824

M 1225			M 1245		M 1246		M 1408		M 1354		M 1365/K	
S 2305			S 2330						M 1356		M 1365/KS	
S 202			S 232		S 242				M 1600		M 1630	
S 203			S 233		S 243				M 1606		M 1660	
S 308			S 330		S 340				S 1200		S 1230	
S 302			S 332		S 342				S 1100		S 1130	
S 303			S 333		S 343				S 1105		S 1132	
S 408			S 430		S 440				S 1106		S 1140	
S 850					S 140				M 1622		M 1650	
S 855									S 1303		S 1336	
S 500			S 530		S 540				M 1618		M 1631	
S 206			S 236						M 1625		M 1665	
S 800			S 830						V 2000		S 1142	
S 805			S 832		S 842		M 1408		S 1125		M 1685	
S 810			S 834						M 1629		M 1685	
S 815			S 836						S 1129		S 1148	
S 816									Z 300		Z 970	
M 1483			M 1493						Z 308		Z 976	
M 1486			M 1495						Z 310		Z 974	
S 250			S 257		S 261				Z 100		Z 170	
S 251			S 255		S 270				Z 402		Z 180	
S 253			S 258		S 272				Z 400		Z 975	
M 1458			M 1479						Z 460		Z 980	
M 1468			M 1459						Z 110		Z 175	
									Z 160		Z 980	
									Z 4100		Z 4430	
									Z 4300		Z 980	
									Z 4400			
									Z 4401			
									Z 2100			
									Z 2105		Z 980	

HAMMER HEAD SCREWS



E 219

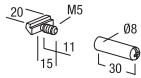

E 203

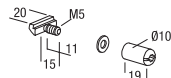

E 205

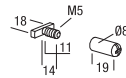

E 207

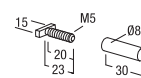

E 209

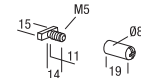

E 210

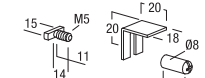

E 211

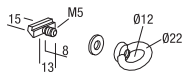

E 218

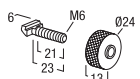

M 1345

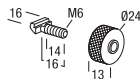

M 1348

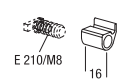

E 217

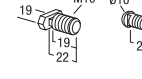

E 265



M 1469

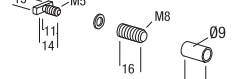

E 210/M8

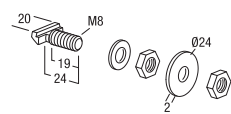

M 1089

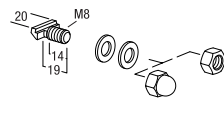

M 1472

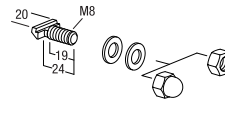

M 1473

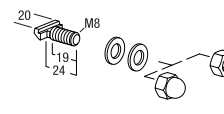

M 1474

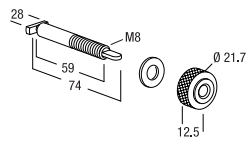

M 1478

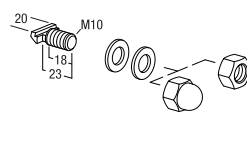

M 812

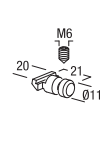

M 1142

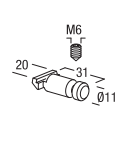

M 1145

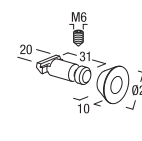

M 1147

CONNECTORS AND THREADED PLATES

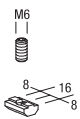

M 826

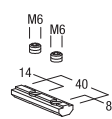

M 1417

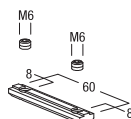

M 1421

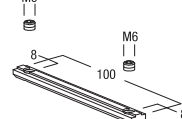

M 1425



M 1671/N

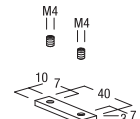

E 212

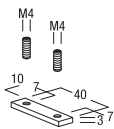

E 213

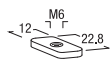

M 1338

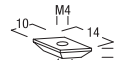

M 1078

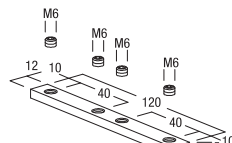

M 1359

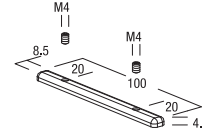

VA 5000

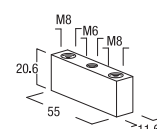

M 1327

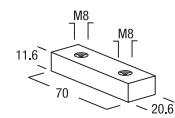

M 1349

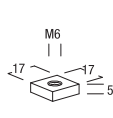

S 4325/2

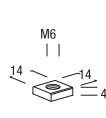

S 4326/1

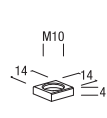

S 4338

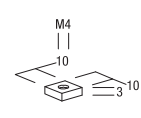

E 470/E

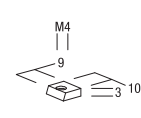

M 1636

PLASTIC EXTRUSIONS



E 440



E 420



E 424



E 421



E 422



E 442

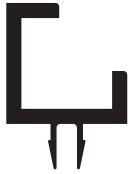

E 443

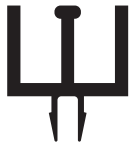

E 400



E 401



M 1319



E 450



E 455



E 451



E 452



E 460



E 441



M 1643



M 1644



E 444



E 445



E 476



E 477

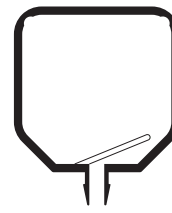

E 463



E 410



M 1360/K



E 480



E 475/N



M 220

AXIS MEASUREMENTS

The sizes of the beams in standard lengths are shown below with their axis measurements, i.e. from center to center of the upright extrusion.

The drawings show our measurement modulus: 495 mm and the matching diagonal measurement of 700 mm.

The four different diameters of the curved beams relate to the standard lengths of the prefabricated straight beams.

STANDARD BEAM LENGTHS

Measurements in mm (inches)

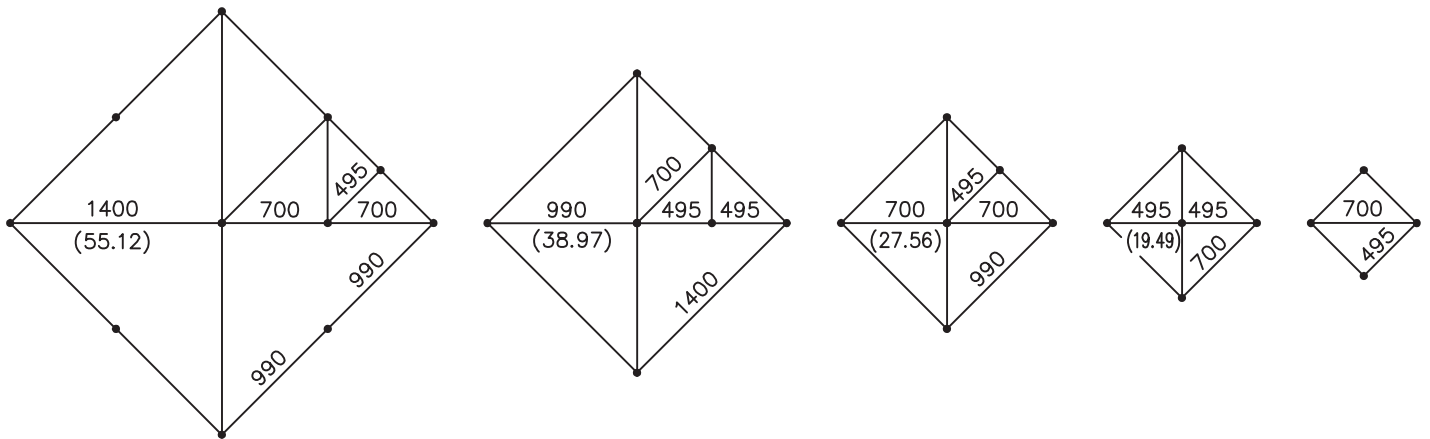

STANDARD ROUND BEAM DIAMETERS

Measurements in mm (inches)

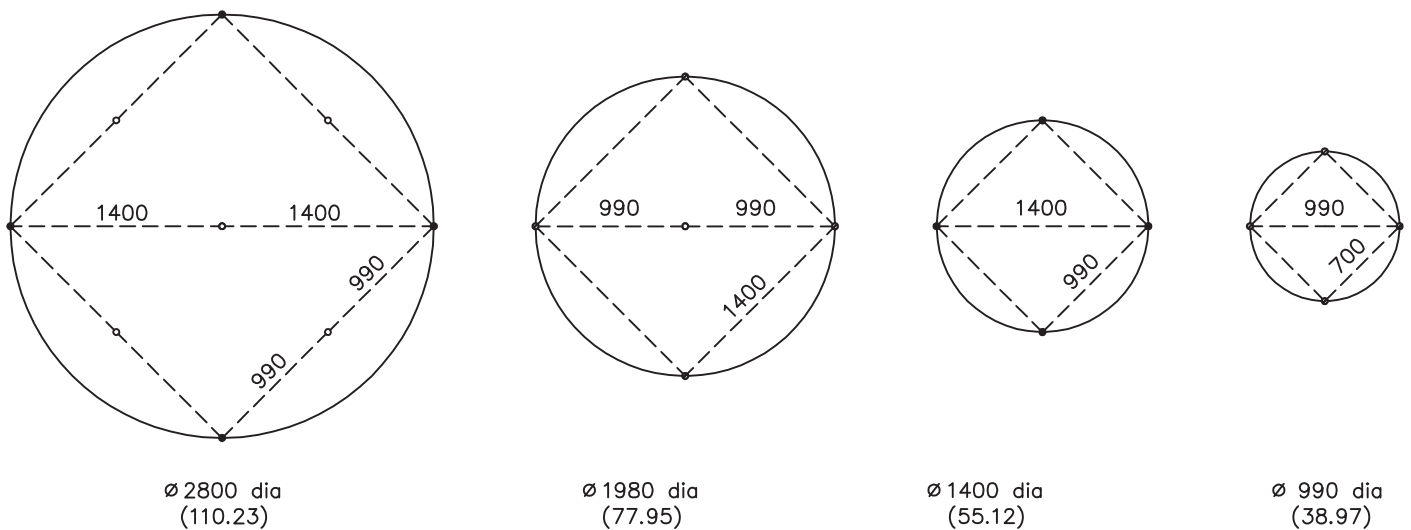

MEASUREMENTS



This leaflet should be helpful in finding the best solution within a variety of possibilities.

Besides the available lengths of 5000 mm we can offer prefabricated beams with installed locks in standard lengths ex stock.
Our wall elements and ceiling panels will match these measurements.

The OCTANORM®-eight-sided upright extrusion is allowing angles from 45° to 315°.

ANGLE MEASUREMENTS/EIGHT-SIDED UPRIGHT EXTRUSION

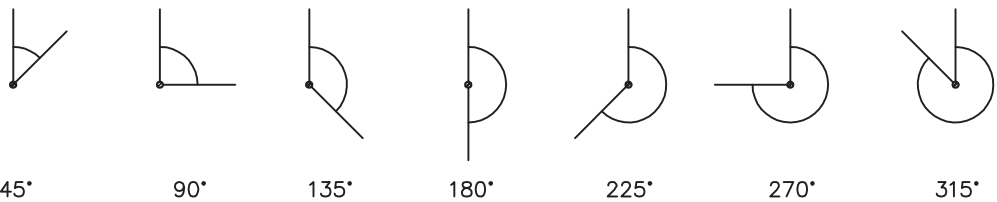

BEAM SIZES

Maße in mm (Inches)

Eight-sided upright extrusion

Standard beam length

Center post to center post measurements

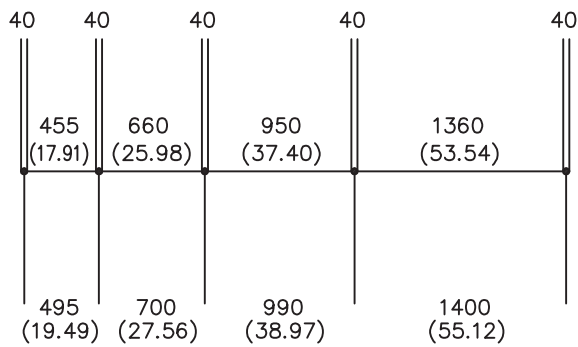

ROUND BEAM SIZES

Measurements in mm (inches)

dia. center post to center post measurements

Center post to center post measurements of the straight beams

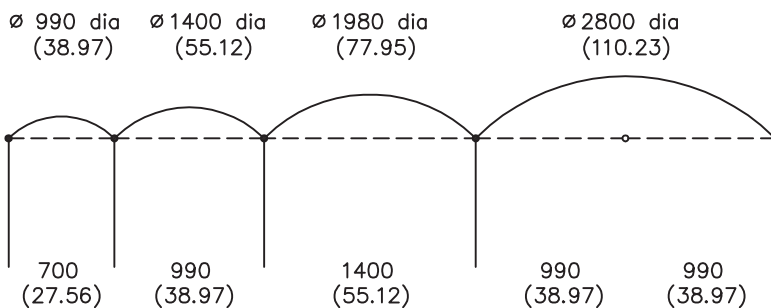

O

4	Accessories
6	Hammerhead Screws
6	Connectors and threaded plates
7	Plastic extrusions
8	Axis measurement

O V E R V I E W S

M A X I M A L I G H T

SQUARE EXTRUSIONS	14
ROUND EXTRUSIONS	33
RECTANGULAR EXTRUSIONS	41
OVAL BEAMS	48
ADAPTORS	51
END PLATES FOR TELESCOPIC SOLUTIONS	58
HINGED END PLATES	60
LOUVER EXTRUSIONS	67
TRUSS BEAMS	68
FLAT TRUSS BEAMS	74
TIE ROD TENSIONING SETS	78
TRUSS GIRDERS	81
LIGHT WALL	94

E X H I B I T I O N S Y S T E M S

UPRIGHTS	102
BEAMS	115
HINGED EXTRUSIONS AND CONNECTORS	134
CEILING GRIDS	139

F A B R I C S U S P E N S I O N S Y S T E M S

FABRIC TENSION EXTRUSIONS	142
FABRIC EXTRUSIONS FOR LIGHT BOX	157
FABRIC SUSPENSION SYSTEMS	160
ROLL-DOWN WALL	163
BANNER SUSPENSION EXTRUSIONS	164
MAGNET RETAINER SYSTEMS	167

P A N E L C L A D W A L L

PANEL CLAD WALL	174
ACCESSORIES	177
WALL PANEL RETAINER	178

I N T E R I O R D E S I G N S Y S T E M S

OCTAFRAME	184
ELLIPTICAL EXTRUSIONS	193

F U R N I S H I N G S Y S T E M S

QUARTER ROUND EXTRUSIONS	198
TRIANGULAR EXTRUSIONS	204
SQUARE EXTRUSIONS	207
135°-EXTRUSIONS	213
BEAM EXTRUSIONS	216

A C C E S S O R I E S

TENSION LOCKS	224
GLASS AND PANEL RETAINER	231
GLASS AND PANEL EXTRUSIONS	242
COVER AND CABLE RETAINER EXTRUSIONS	247
EDGE PROTECTION EXTRUSIONS	252
CONNECTOR EXTRUSIONS	253
CONNECTORS	254
HINGE PLATES AND HINGES	268
SHOWCASE AND FURNITURE ACCESSORIES	272
HAMMERHEAD SCREWS AND SHELF SUPPORTS	278
SHELF BRACKETS	284
BRACING PARTS	289
FIXING AND SECURITY PARTS	291
MISCELLANEOUS	300
ADJUSTABLE FEET AND CASTORS	301
BASE PLATES	305
SUPPORT FRAMES	311
WARDROBE SYSTEMS	313
LIGHTING AND ELECTRIC	316
MONITOR SUPPORT SYSTEMS	318
LITERATURE RACKS	321
DOORS	326

T O O L S , T R A N S P O R T

PNEUMATIC PRESS	336
TOOLS	339
DRILLING JIGS AND DRILLS	345
TRANSPORT CASES	354

S O F T W A R E A N D S E R V I C E

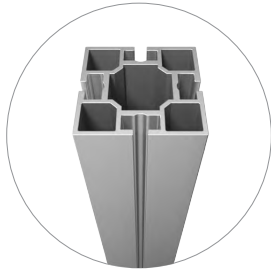

Square Extrusions | 40 mm
14

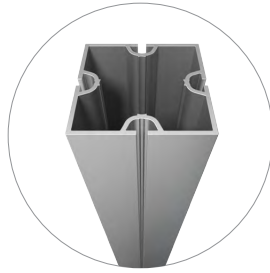

Square Extrusions | 60 mm
18

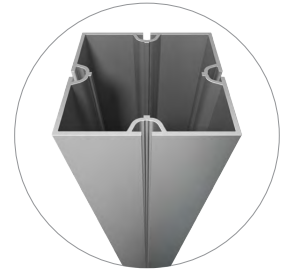

Square Extrusions | 80 mm
19

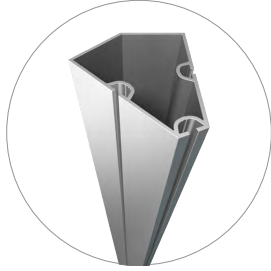

Square Extrusions | 80 mm, 135°
26

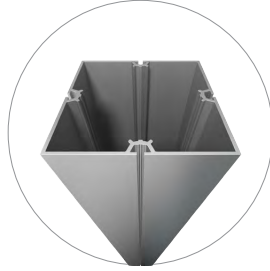

Square Extrusions | 120 mm
27

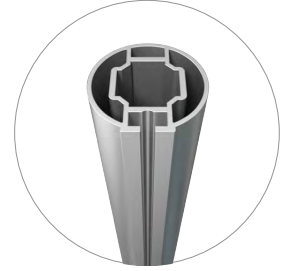

Round Extrusions | 40 mm
33

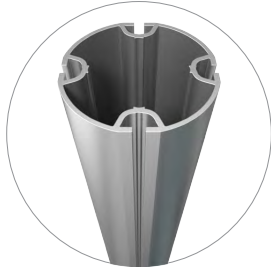

Round Extrusions | 60 mm
34



Round Extrusions | 80 mm
35



Round Extrusions | 120 mm
36

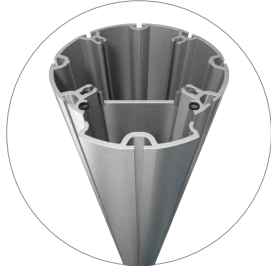

Round Extrusions | 120 mm open
38

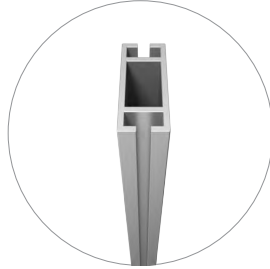

Rectangular Extrusions | 40 x 16 mm
41

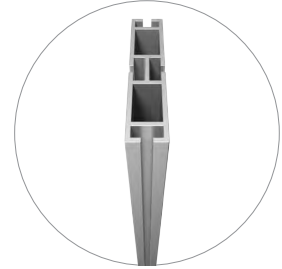

Rectangular Extrusions | 80 x 16 mm
41



Rectangular Extrusions | 120 x 16 mm
41

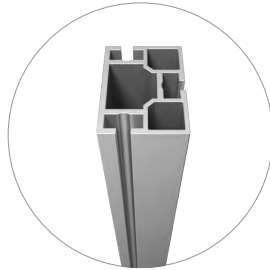

Rectangular Extrusions | 40 x 28 mm
41

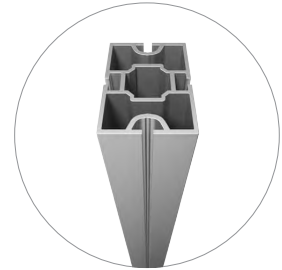

Rectangular Extrusions | 60 x 40 mm
42

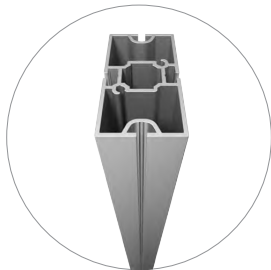

Rectangular Extrusions | 80 x 40 mm
42

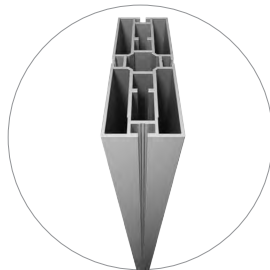

Rectangular Extrusions | 120 x 40 mm
44

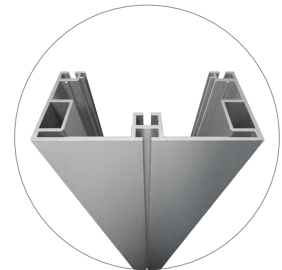

Rectangular Extrusions | 120 x 60 mm
46

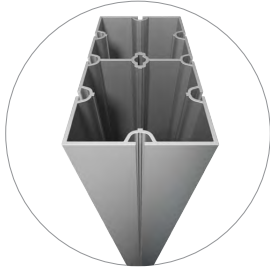

Rectangular Extrusions | 160 x 80 mm

46

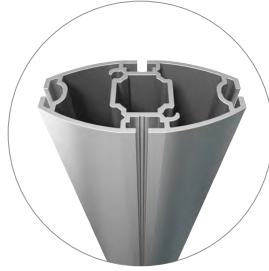

Oval Beams | 80 x 40 mm

48

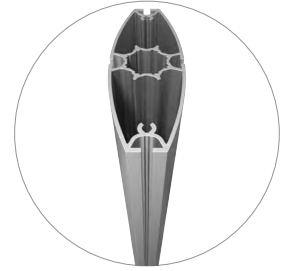

Oval Beams | 120 x 40 mm

49

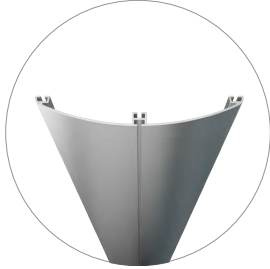

Oval Beams | 230 x 40 mm

49

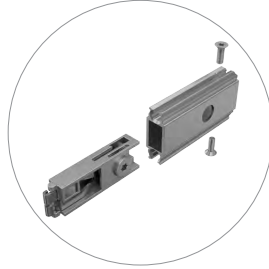

Adaptors

51

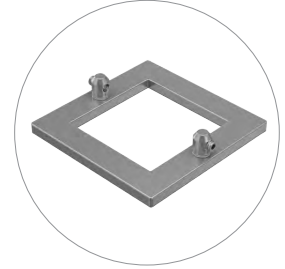

End Plates for telescopic solutions

58



Hinged End Plates

60



Louver Extrusions

67



Truss Beams

68

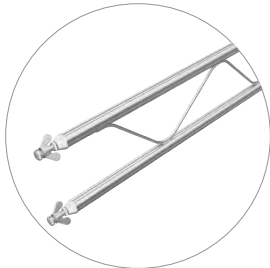

Flat Truss Beams

74

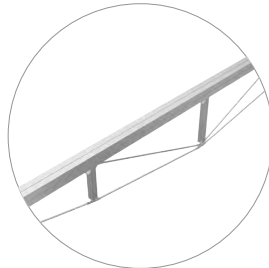

Tie Rod Tensioning Sets

78

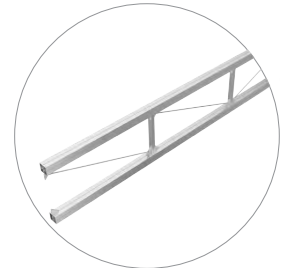

Truss Girders

81



Truss Girders | Accessories

90

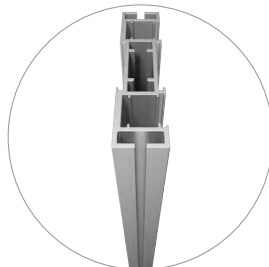

Light Wall

94

MAXIMA LIGHT

SQUARE EXTRUSIONS

SQUARE EXTRUSION 40 MM

aluminium
tension lock Z 961/8 can be mounted in
2 positions
5000 mm long
6.24 kg

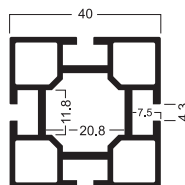
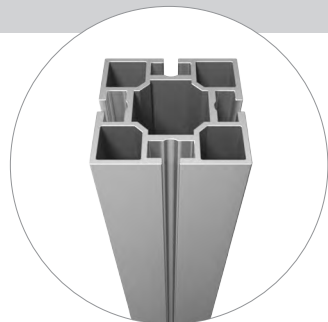

M 1000 40 MM

M 1000.01

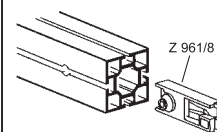

SQUARE EXTRUSION 40 MM

aluminium
tension lock Z 961/8 can be mounted in
2 positions
6000 mm long
7.48 kg

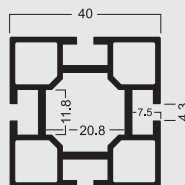

M 1001

M 1001.01

SQUARE EXTRUSION 40 MM

aluminium
tension lock Z 961/8 can be mounted in
2 positions
5000 mm long
5.78 kg

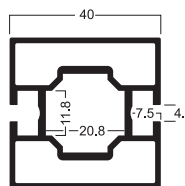
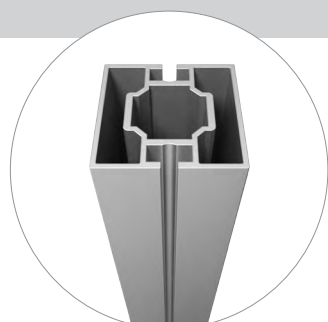

M 1002

M 1002.01

SQUARE EXTRUSION 40 MM

aluminium
tension lock Z 961/8 can be mounted in
2 positions
6000 mm long
6.922 kg

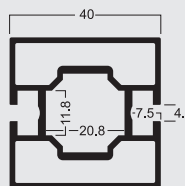

M 1003

M 1003.01

SQUARE EXTRUSION 40 MM

aluminium
tension lock Z 961/8 can be mounted in
2 positions
groove depth 7 mm
6000 mm long
7.12 kg

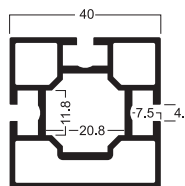
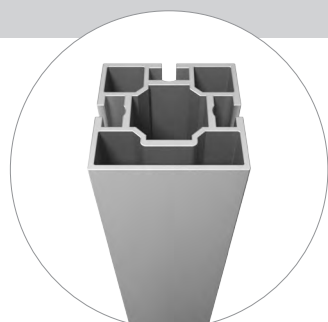

M 1005

M 1005.01

SQUARE EXTRUSIONS

SQUARE EXTRUSION 40 MM

aluminium
tension lock Z 961/8 can be mounted in
2 positions
6000 mm long
7.22 kg

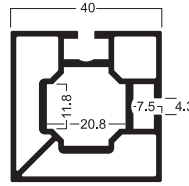

M 1007

M 1007.01

UPRIGHT EXTRUSION

aluminium
tension lock Z 961/8 can be mounted in
4 positions
5000 mm long
7.49 kg

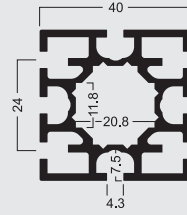

S 208

S 208.01
S 208.11

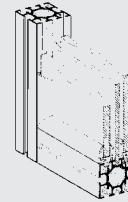

UPRIGHT EXTRUSION

aluminium
tension lock Z 961/8 can be mounted in
4 positions
6000 mm long
8.988 kg

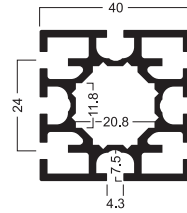
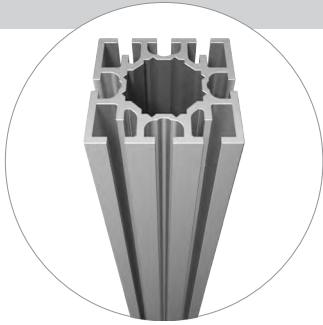

S 209

S 209.01

UPRIGHT EXTRUSION

aluminium
tension lock Z 961/8 can be mounted in
5 positions
5000 mm long
5.97 kg

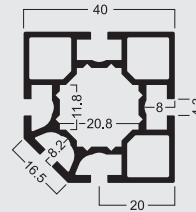

S 380

S 380.01

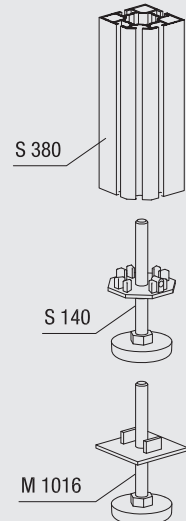

SQUARE EXTRUSIONS

END CAP

plastic
for all square extrusions 40 mm
0.004 kg

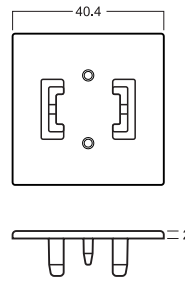

M 1014

40 MM

M 1014.35

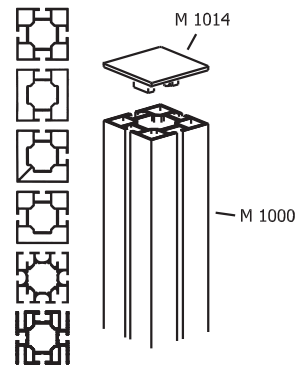

END PLATE

die cast
for all square extrusions 40 mm
0.033 kg

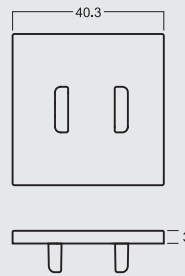
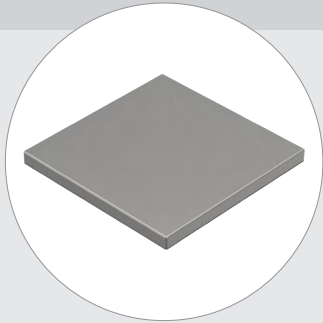

M 1015

M 1015.21

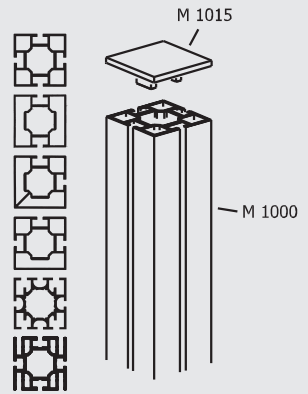

KNUCKLE JOINT

zinc die cast
incl. 3 countersunk screws E 2600/20
for mounting 3 square extrusions 40 mm
0.4 kg

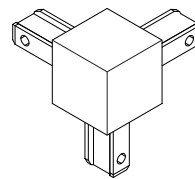
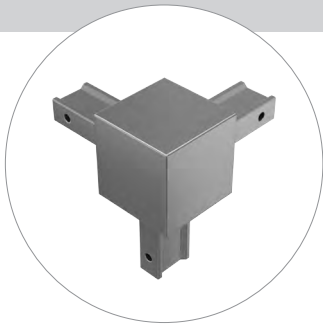

M 1073

M 1073.39

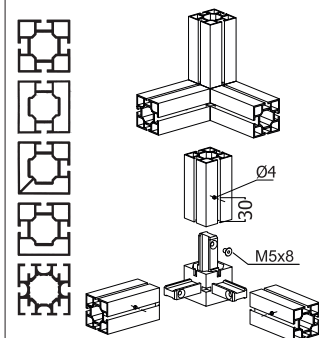

SQUARE EXTRUSIONS

ADJUSTABLE FOOT

zinc die cast/steel
thread M8
incl. 1 set screw E 212/Z (M4)
for all square extrusions 40 mm
0.116 kg

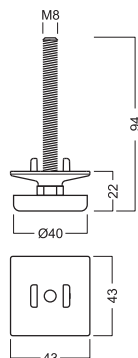
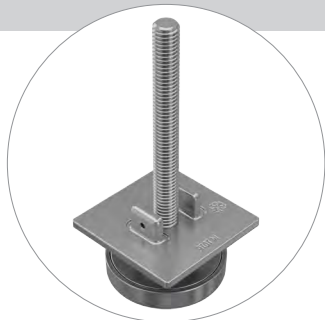

M 1016

M 1016.37

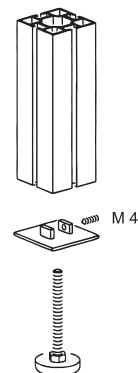

EXTERIOR CORNER EXTRUSION 135°

aluminium
tension lock Z 961/8 can be mounted in 2
positions
6000 mm long
8.37 kg

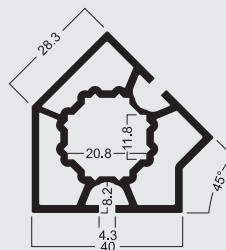
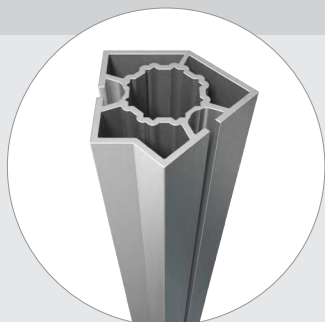

M 1009

M 1009.01

ADJUSTABLE FOOT,
135° CORNER

steel, galvanized
incl. 2 set screws M 1075/20 (M4)
for exterior corner extrusion M 1009
0.158 kg

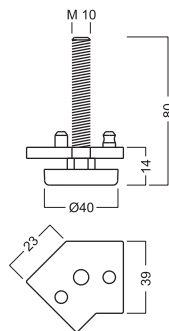
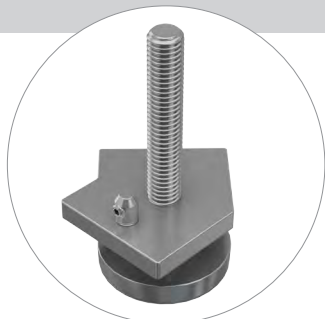

C 441

C 441.37

HINGED EXTRUSION

aluminium
two-parts
5000 mm long
5.602 kg

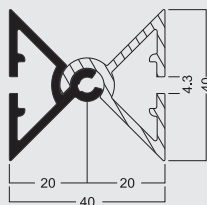

W 908

W 908.01

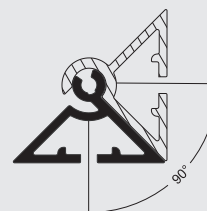

MAXIMA LIGHT

SQUARE EXTRUSIONS

SQUARE EXTRUSION 60 MM

aluminium
adaptor with tension lock M 1100 and
adaptor for hinged end plates M 1555 can
be mounted
5000 mm long
8 kg

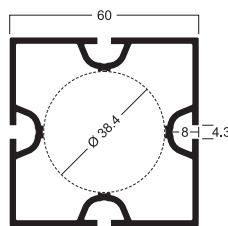
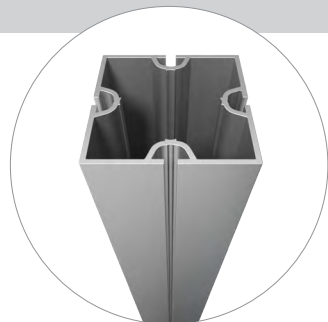

M 1010 **60 MM**

M 1010.01

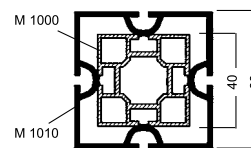

SQUARE EXTRUSION 60 MM

aluminium
adaptor with tension lock M 1100 and
adaptor for hinged end plates M 1555 can
be mounted
6000 mm long
9.74 kg

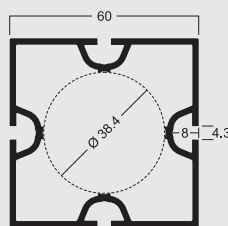

M 1011

M 1011.01

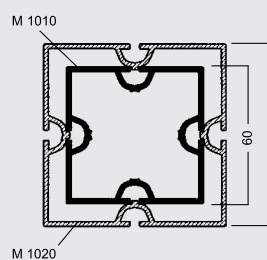

END PLATE

steel
incl. 2 set screws M 1075/20 (M4)
for square extrusions 60 mm
0.09 kg

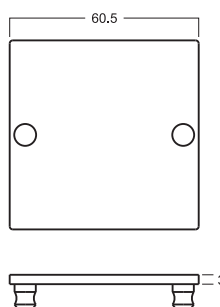
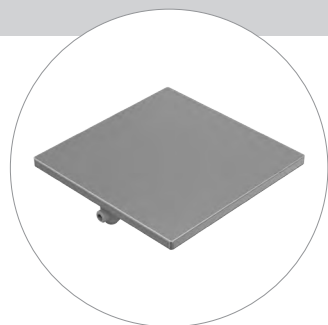

M 1065

M 1065.21

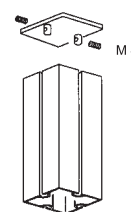

ADJUSTABLE FOOT

steel
thread M10,
incl. 2 set screws M 1075/20 (M4)
for square extrusions 60 mm
0.23 kg

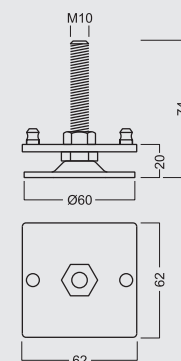
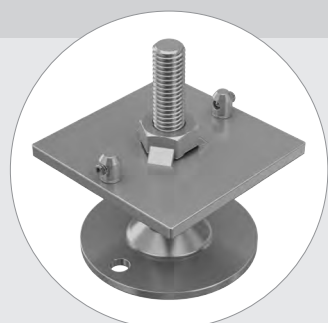

M 1067

M 1067.37

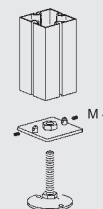

SQUARE EXTRUSIONS

SQUARE EXTRUSION 80 MM

aluminium
adaptors with tension lock M 1101, M 1103,
adaptors with safety tension lock M 1114,
M 1116
and adaptor for hinged end plates M 1281
can be mounted
5000 mm long
11.42 kg

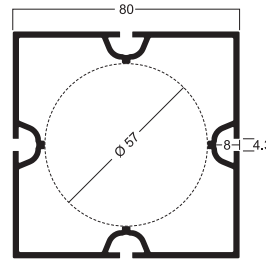

M 1020 80 MM

M 1020.01

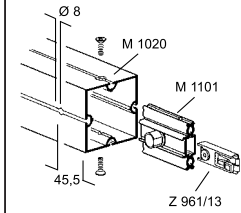

SQUARE EXTRUSION 80 MM

aluminium
adaptors with tension lock M 1101, M 1103,
adaptors with safety tension lock M 1114,
M 1116
and adaptor for hinged end plates M 1281
can be mounted
6000 mm long
13.716 kg

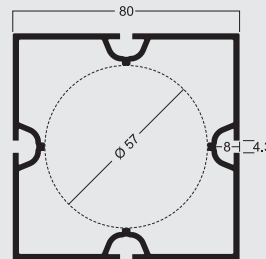

M 1021

M 1021.01

CORNER CONNECTOR 80 MM

aluminium
with eye bolt for cable suspension and
4 slots for secure tension lock M 1161/L
and M 1161/R
0.825 kg

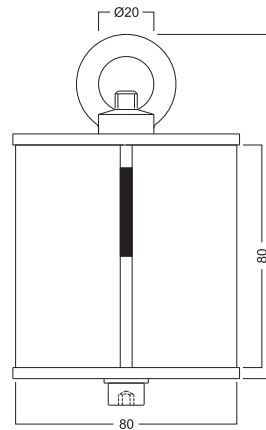

M 1401

M 1401.01

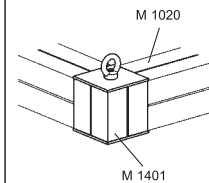

CONNECTOR "TOP" 80 MM

aluminium
with 4 cut-outs for secure tension lock
M 1161/L and M 1161/R
0.579 kg

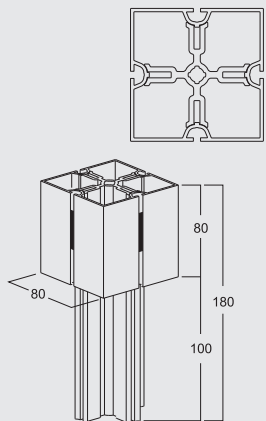
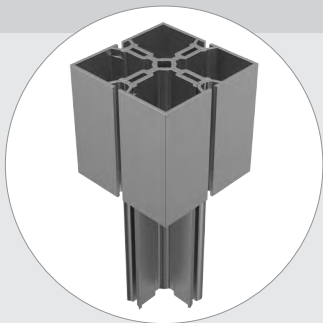

M 1180

M 1180.01

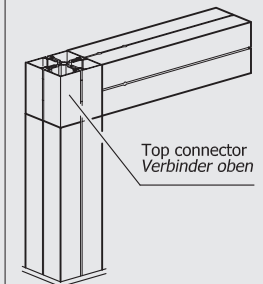

SQUARE EXTRUSIONS

CONNECTOR "CENTRE" 80 MM

aluminium
with 4 cut-outs for secure tension lock
M 1161/L and M 1161/R
0.984 kg

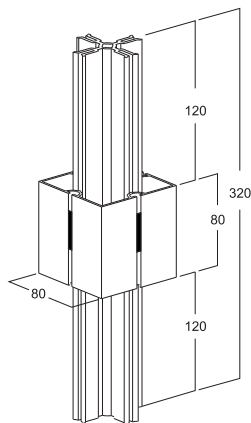
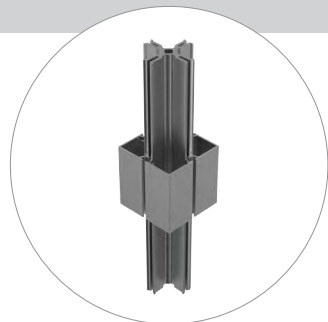

M 1182

80 MM

M 1182.01

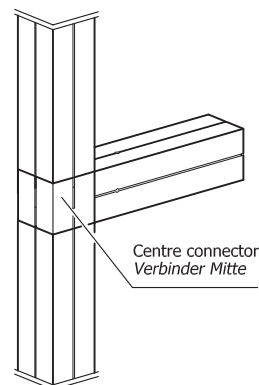

CONNECTOR "BOTTOM" 80 MM

aluminium
with 4 cut-outs for secure tension lock
M 1161/L and M 1161/R
incl. adjustable foot M 1184/3 and foot
plate M 1184/2
1.016 kg

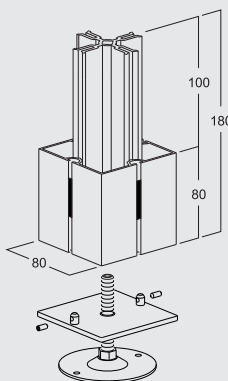
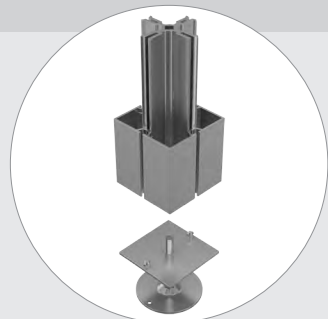

M 1184

M 1184.01

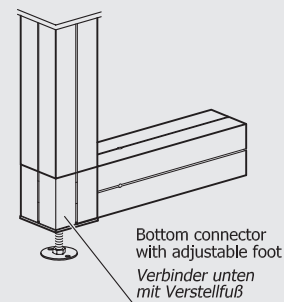

Attention:

Adjustment of the M1184 connector nodes is urgently required

ACHTUNG:

Nivellierung der Verbinderknoten M 1184 dringend erforderlich

SQUARE EXTRUSION 80 MM

aluminium
tension lock Z 961/8 can be mounted
5000 mm long
14.91 kg

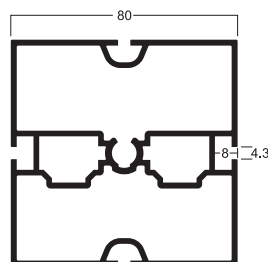
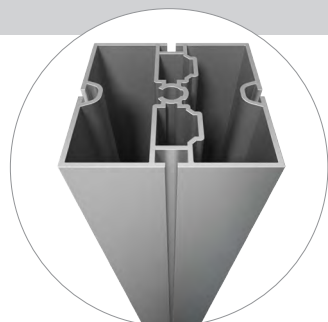

M 1018

M 1018.01

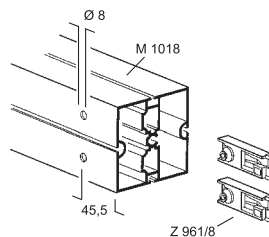

SQUARE EXTRUSIONS

SQUARE EXTRUSION 80 MM

aluminium
tension lock Z 961/8 can be mounted
6000 mm long
17.8 kg

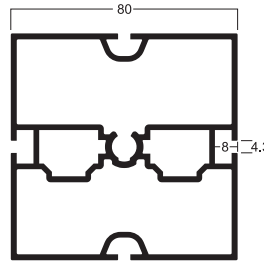
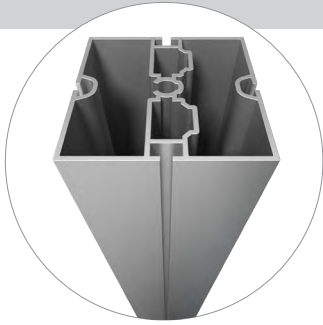

M 1019

M 1019.01

SQUARE EXTRUSION 80 MM

aluminium
adaptors with tension lock M 1101, M 1103,
adaptors with safety tension lock M 1114,
M 1116
and adaptor for hinged end plates M 1281
can be mounted
5000 mm long
11.714 kg

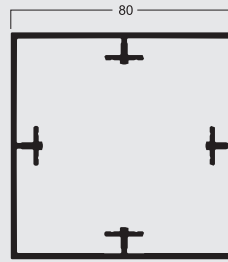

M 2020

M 2020.01

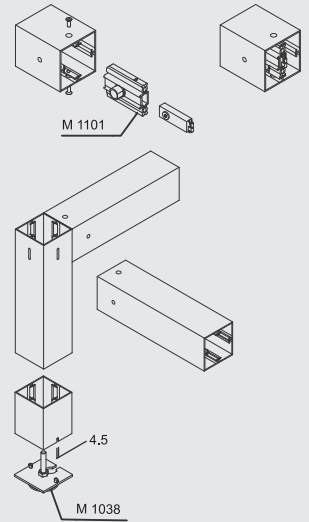

LIGHTTRACK MOUNTING
EXTRUSION 80 MM

aluminium
adaptor with tension lock M 1151 can be mounted
5000 mm long
13.293 kg

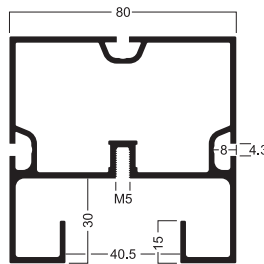
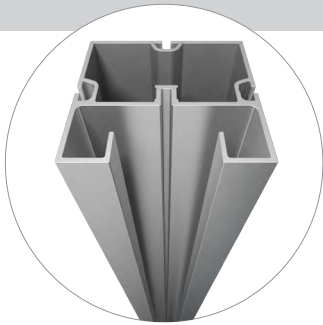

M 1058

M 1058.01

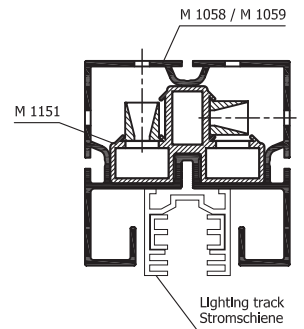

MAXIMA LIGHT

SQUARE EXTRUSIONS

LIGHTTRACK MOUNTING EXTRUSION 80 MM

aluminium
adaptor with tension lock M 1151 can be mounted
6000 mm long
15.92 kg

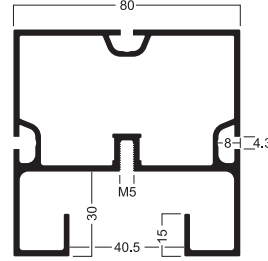
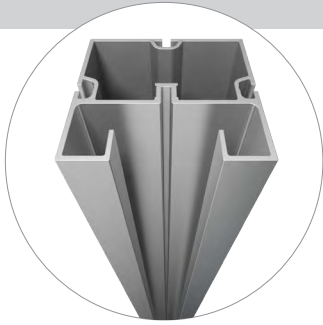

M 1059

80 MM

M 1059.01

COVER EXTRUSION

aluminium
can be used only with lighttrack mounting extrusions M 1058, M 1059
5000 mm long
3.456 kg

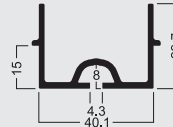

M 1155

M 1155.01

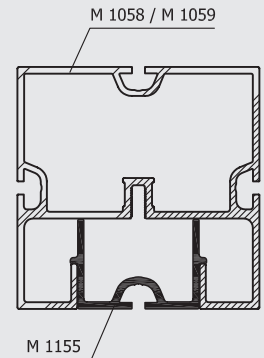

ADAPTOR WITH TENSION LOCK

aluminium
incl. 2 tension locks Z 961/13,
2 bushes M 1151/2
and 2 cylinder screws M 1151/20 (M6)
for lighttrack mounting extrusions M 1058,
M 1059
108 mm long
0.286 kg

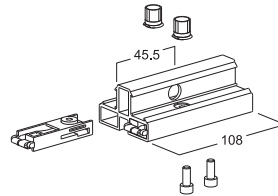
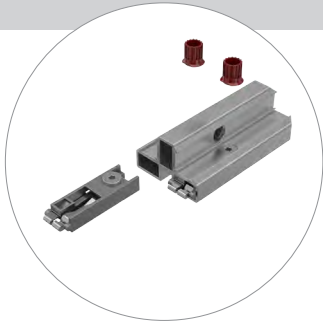

M 1151

M 1151.00

INTERNAL CONNECTOR STRAIGHT

aluminium
incl. 4 countersunk screws M 1611/20 (M5)
for lighttrack mounting extrusions M 1058,
M 1059 with a length up to 999 mm
320 mm long
0.505 kg

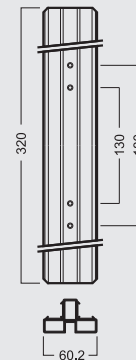

M 1181

M 1181.00

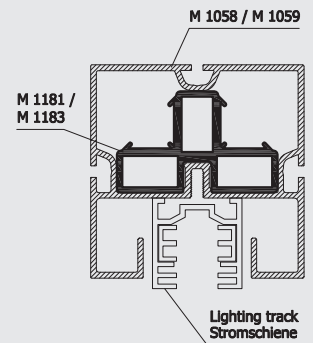

SQUARE EXTRUSIONS

INTERNAL CONNECTOR STRAIGHT

aluminium
incl. 4 countersunk screws M 1611/20 (M5)
for lighttrack mounting extrusions M 1058,
M 1059 with a length from 1000 - 3000 mm
480 mm long
0.718 kg

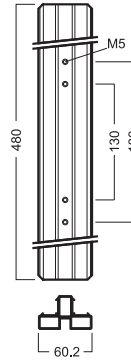

M 1183

M 1183.00

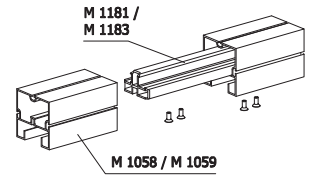

END CAP

plastic
for square extrusions M 1012, M 1018,
M 1020, M 1022 and lighttrack mounting
extrusions M 1058, M 1059
0.021 kg

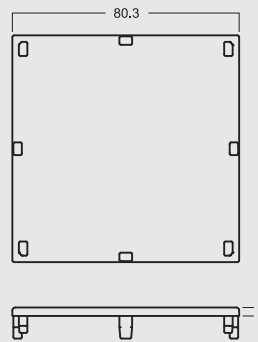

M 1034

M 1034.35

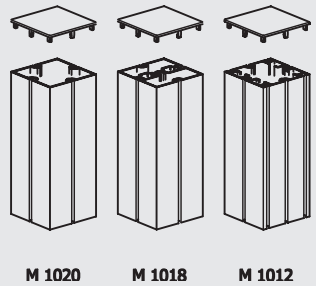

END PLATE

steel
incl. 2 set screws M 1075/20 (M4)
for square extrusions M 1012, M 1018,
M 1020, M 1022 and lighttrack mounting
extrusions M 1058, M 1059
0.156 kg

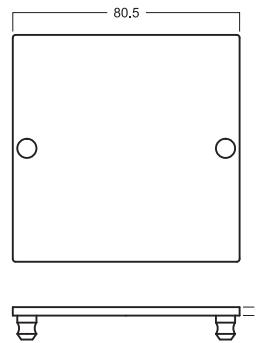
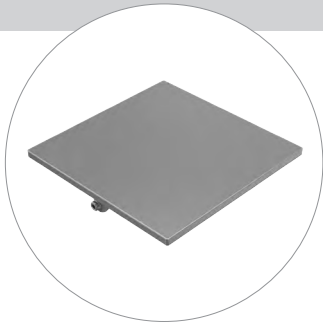

M 1035

M 1035.21

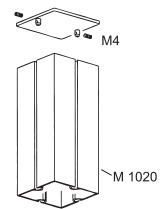

MAXIMA LIGHT

SQUARE EXTRUSIONS

ADJUSTABLE FOOT

steel
thread M10
incl. 2 set screws M 1075/20 (M4)
for square extrusions M 1012, M 1020,
M 1022
0.31 kg

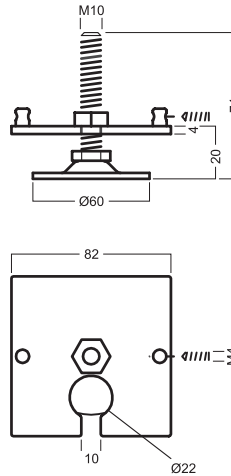
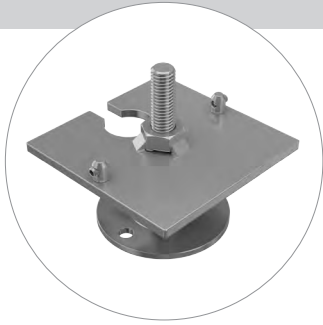

M 1038 **80 MM**

M 1038.37

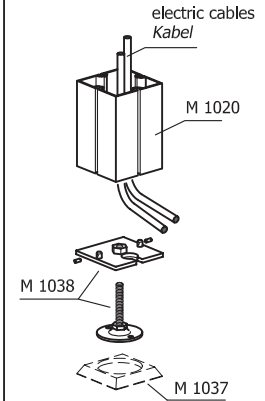

**BASE PLATE FOR
ADJUSTABLE FOOT**

plastic, black
for adjustable foot M 1038
Attention:
increases total height by 6 mm
0.023 kg

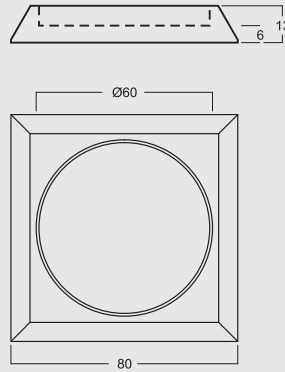

M 1037

M 1037.33

SQUARE EXTRUSION 80 MM

aluminium
8 system grooves
adaptors with tension lock M 1101, M 1103
can be mounted
5000 mm long
15.48 kg

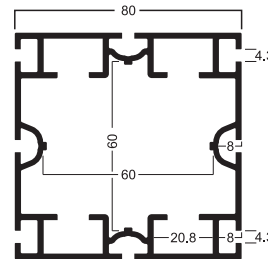
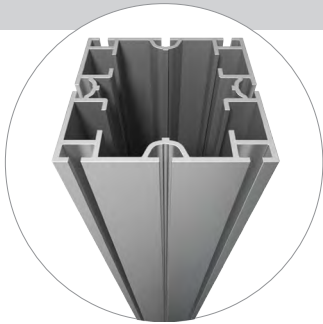

M 1012

M 1012.01

M 1012 for use with
M 1012 in Funktion mit:

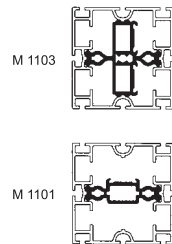

SQUARE EXTRUSION 80 MM

aluminium
8 system grooves
adaptors with tension lock M 1101, M 1103
can be mounted
6000 mm long
18.622 kg

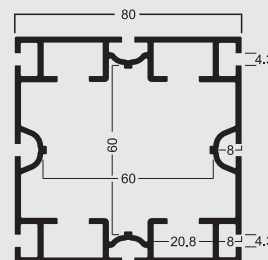
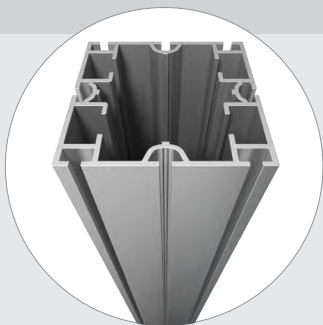

M 1013

M 1013.01

SQUARE EXTRUSIONS

SQUARE EXTRUSION 84 MM

aluminium
8 system grooves
adaptors with tension lock M 1101, M 1103
can be mounted
5000 mm long
12.05 kg

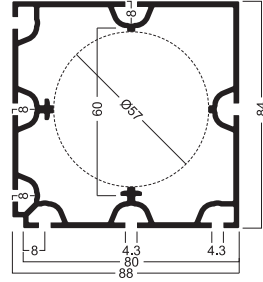
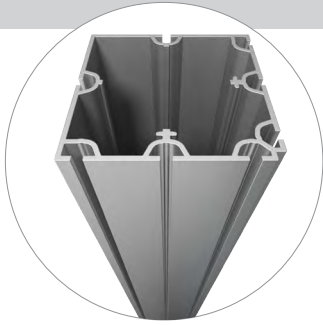

M 1017

M 1017.01

M 1017 for use with
M 1017 in Funktion mit:

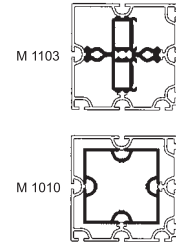

SQUARE EXTRUSION
"OPEN" 80 MM

aluminium
incl. 6 reinforcement extrusions M 1130,
each 65 mm long
and 1 set screw M 1130/20 (M5)
adaptors with tension lock M 1101, M 1103
and adaptors with safety tension lock
M 1114, M 1116 can be mounted
5000 mm long
15.657 kg

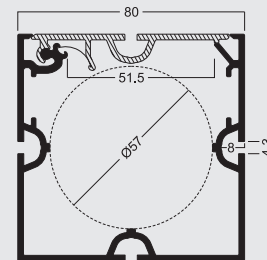

M 1022

M 1022.01

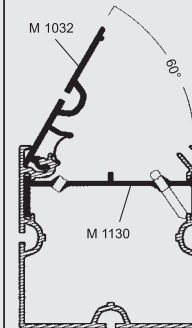

SQUARE EXTRUSION
"OPEN" 80 MM

aluminium
incl. 8 reinforcement extrusions M 1130,
each 65 mm long
and 1 set screw M 1130/20 (M5)
adaptors with tension lock M 1101, M 1103
and adaptors with safety tension lock
M 1114, M 1116 can be mounted
6000 mm long
17.238 kg

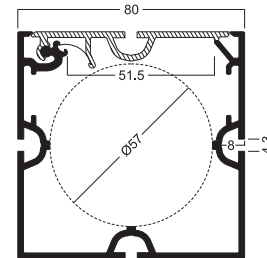
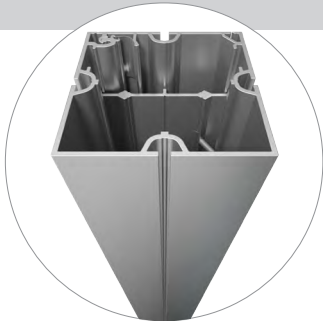

M 1023

M 1023.01

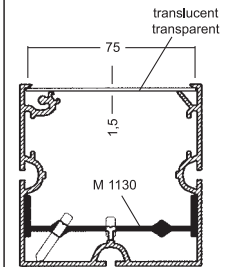

CONNECTING EXTRUSION

aluminium
5 system grooves 4.3 mm
5000 mm long
5.455 kg

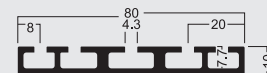

M 1063

M 1063.01

SQUARE EXTRUSIONS

CONNECTOR PART SET

aluminium
with 2 slots 16 x 26 mm
incl. 2 fixing sets M 1089
for mounting to square extrusions 80 mm
200 mm long
0.287 kg

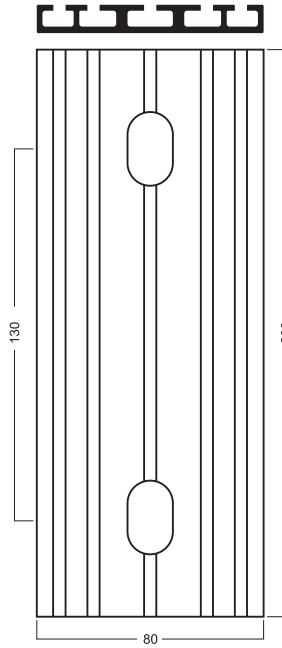

M 1079

80 MM

M 1079.01

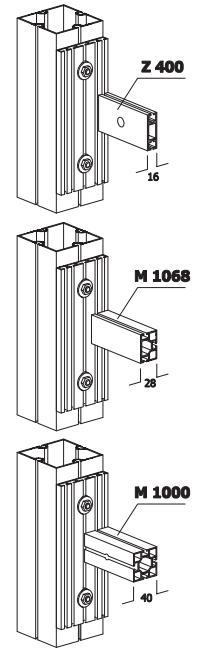

FIXING SET

steel
for mounting of connector part M 1079 in
front of square extrusions 80 mm
0.03 kg

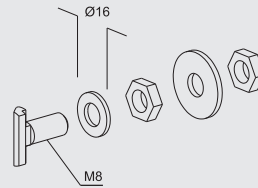
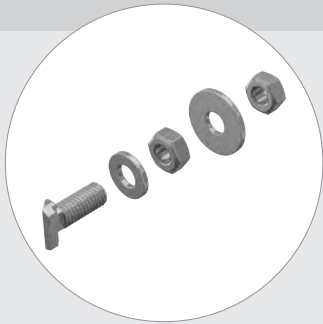

M 1089

M 1089.37

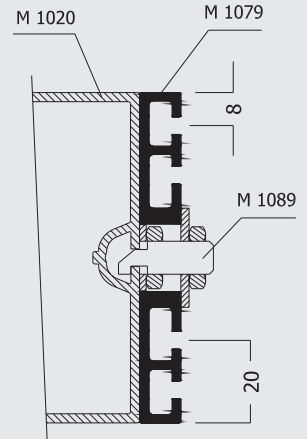

EXTERIOR CORNER
EXTRUSION 135°

aluminium
5000 mm long
8.375 kg

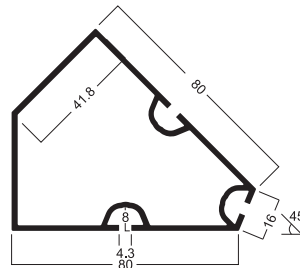

M 1070

80 MM, 135°

M 1070.01

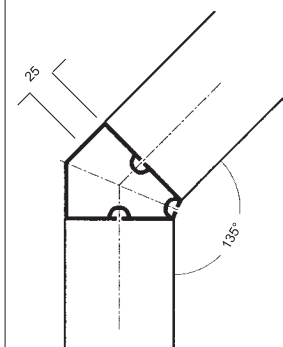

SQUARE EXTRUSIONS

END PLATE 135°

steel
incl. 2 set screws M 1075/20 (M4)
for exterior corner extrusion M 1070
0.101 kg

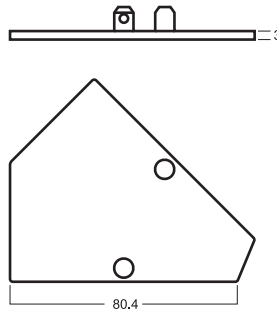

M 1095

M 1095.21

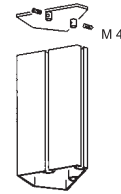

ADJUSTABLE FOOT 135°

steel
thread M10
incl. 1 set screw M 1075/20 (M4)
for exterior corner extrusion M 1070
0.26 kg

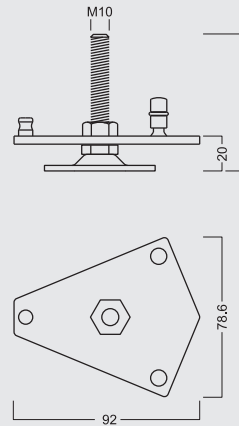
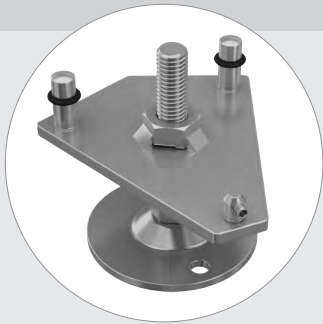

M 1096

M 1096.37

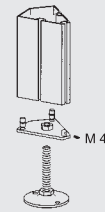

SQUARE EXTRUSION 120 MM

aluminium
adaptors with tension lock M 1102, M 1122,
adaptors with safety tension lock M 1124,
M 1126
and adaptor for hinged end plates M 1282
can be mounted
5000 mm long
18.65 kg

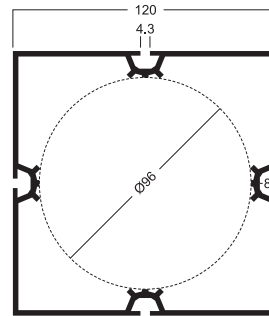
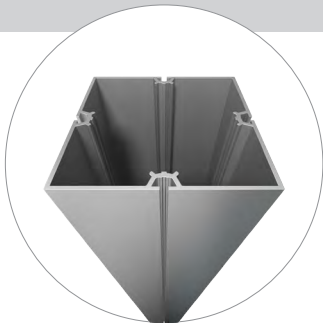

M 225

120 MM

M 225.01

SQUARE EXTRUSION 120 MM

aluminium
adaptors with tension lock M 1102, M 1122,
adaptors with safety tension lock M 1124,
M 1126
and adaptor for hinged end plates M 1282
can be mounted
6000 mm long
23.53 kg

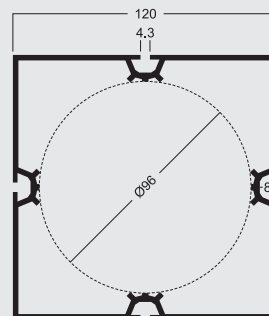

M 226

M 226.01

SQUARE EXTRUSIONS

SQUARE EXTRUSION 120 MM

aluminium
adaptors with tension lock M 1102, M 1122,
adaptors with safety tension lock M 1124,
M 1126
and adaptor for hinged end plates M 1282
can be mounted
6930 mm long
27.14 kg

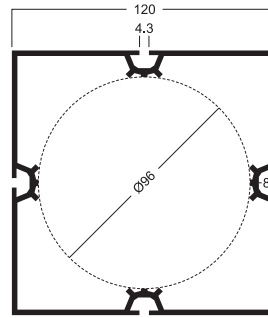
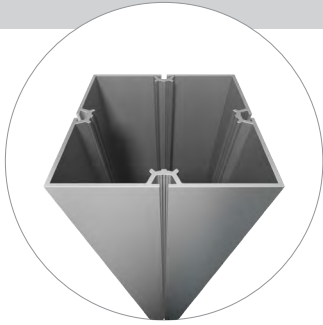

M 227

120 MM

M 227.01

CORNER CONNECTOR 120 MM

aluminium
with eye bolt for cable suspension
with 8 slots for secure tension lock
M 1161/L and M 1161/R
1.929 kg

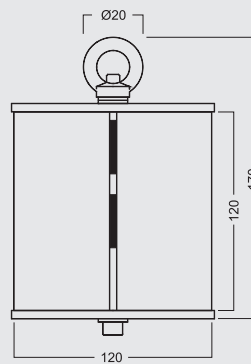
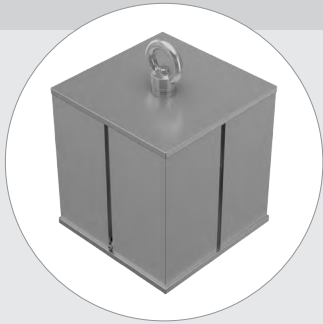

M 1410

M 1410.01

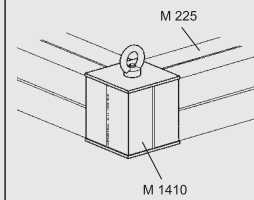

CONNECTOR "TOP" 120 MM

aluminium
with 8 slots for secure tension lock
M 1161/L und M 1161/R
1.806 kg

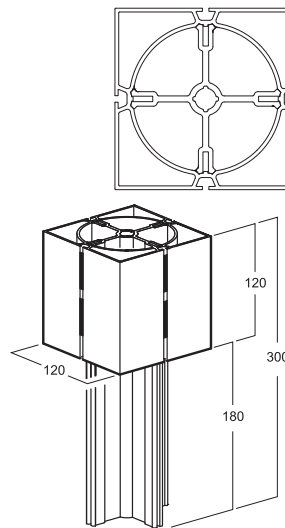
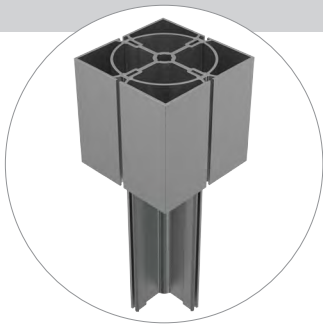

M 1190

M 1190.01

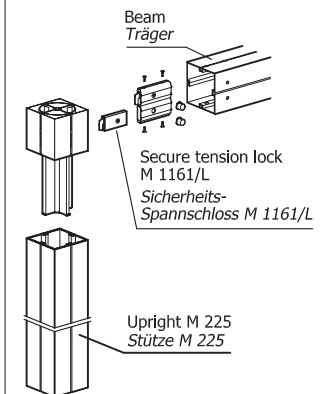

SQUARE EXTRUSIONS

CONNECTOR "CENTRE" 120 MM

aluminium
with 8 slots for secure tension lock
M 1161/L and M 1161/R
2.329 kg

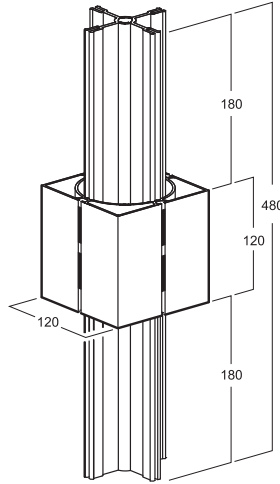
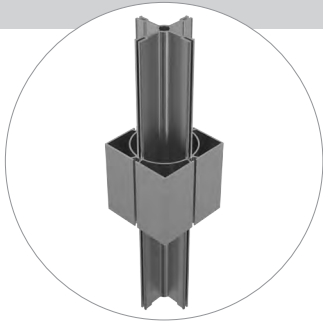

M 1192

M 1192.01

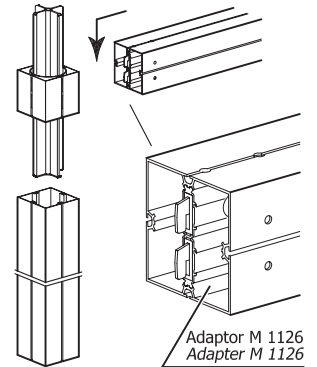

CONNECTOR "BOTTOM" 120 MM

aluminium
with 8 slots for secure tension lock
M 1161/L and M 1161/R
incl. adjustable foot M 285/1 and foot plate
M 1192/2
2.596 kg

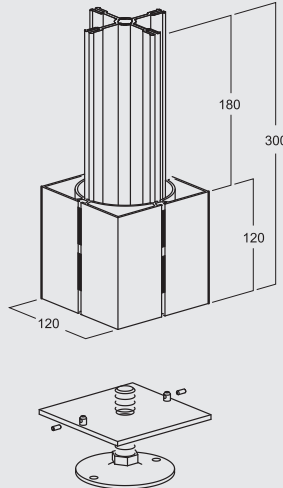
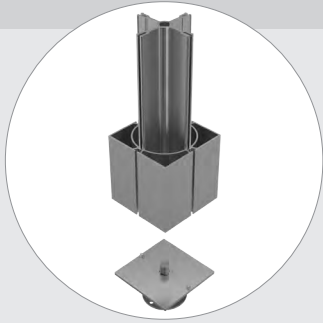

M 1194

M 1194.01

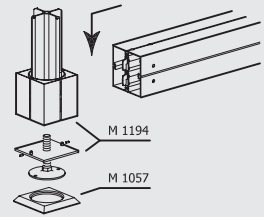

SQUARE EXTRUSION 120 MM

aluminium
adaptors with tension lock M 1102 and
M 1122 can be mounted
5000 mm long
29.5 kg

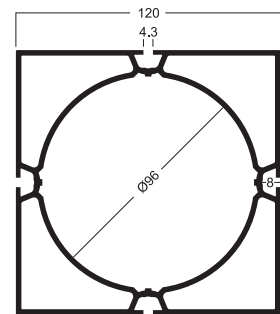
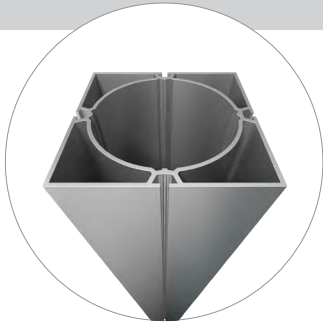

M 230

M 230.01

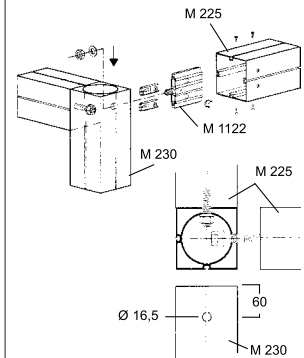

SQUARE EXTRUSIONS

SQUARE EXTRUSION 120 MM

aluminium
adaptors with tension lock M 1102 and M 1122 can be mounted
6930 mm long
38.836 kg

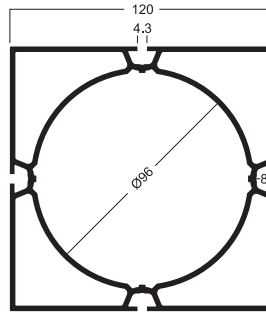
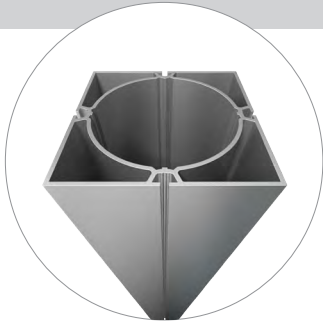

M 232

120 MM

M 232.01

SQUARE EXTRUSION "OPEN" 120 MM

aluminium
incl. 6 reinforcement extrusions M 1110, each 80 mm long and 1 set screw M1110/20 (M5) adaptors with tension lock M 1104/R and M 1104/L can be mounted
5000 mm long
18.24 kg

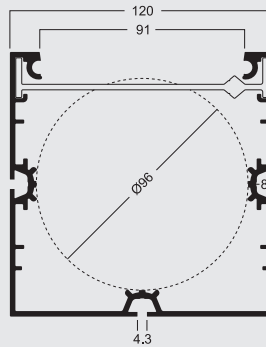
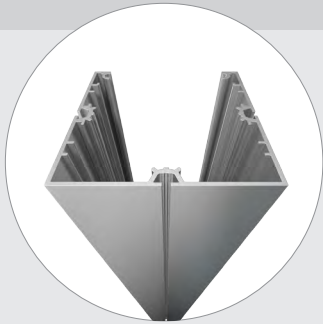

M 1040

M 1040.01

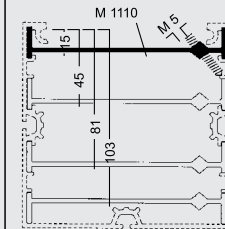

COVER EXTRUSION

aluminium
incl. 2 round cords M 264, each 5000 mm long for M 1040
5000 mm long
4.43 kg

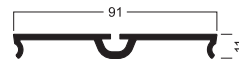

M 1045

M 1045.01

SQUARE EXTRUSION "OPEN" 120 MM

aluminium
incl. 6 reinforcement extrusions M 1110, each 80 mm long and 1 set screw M 1110/20 (M5) adaptors with tension lock M 1104/R and M 1104/L can be mounted
6000 mm long
21.85 kg

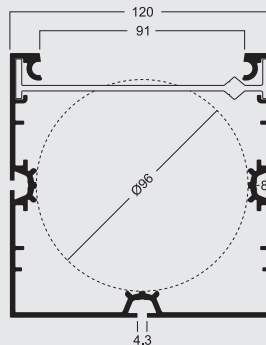

M 1041

M 1041.01

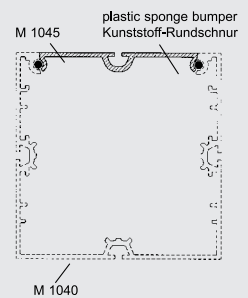

SQUARE EXTRUSIONS

COVER EXTRUSION

aluminium
incl. 2 round cords M 265,
each 6000 mm long
for M 1041
6000 mm long
5.3 kg

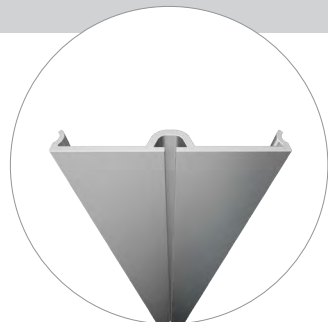

M 1046

M 1046.01

REINFORCEMENT EXTRUSION

aluminium
incl. 1 set screw M 1110/20 (M5)
for reinforcement of open square extrusions
120 mm
80 mm long
0.082 kg

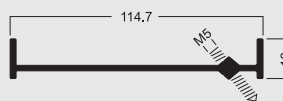
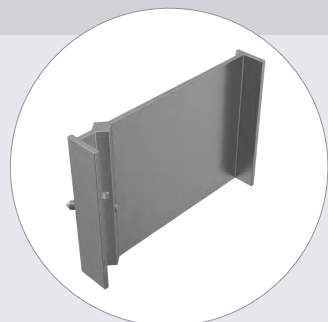

M 1110

M 1110.00

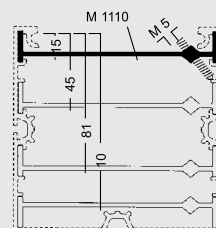

END PLATE

steel
incl. 2 set screws M 1075/20 (M4)
for all square extrusions 120 mm
0.351 kg

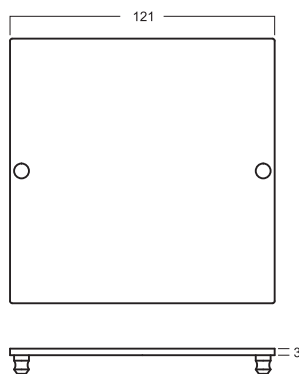
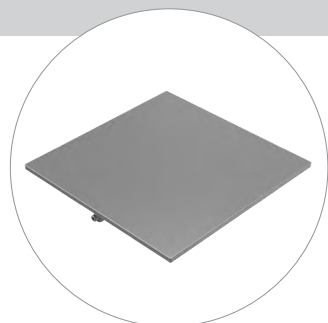

M 274

M 274.21

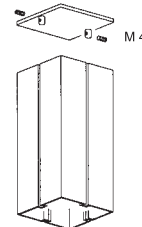

ADJUSTABLE FOOT

steel
thread M16
incl. 2 set screws M 1075/20 (M4)
for all square extrusions 120 mm
0.79 kg

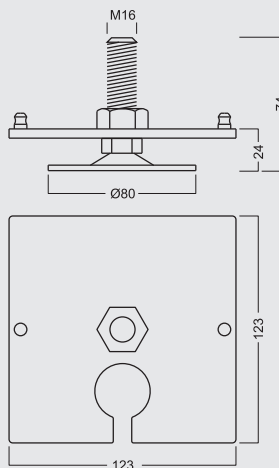

M 285

M 285.37

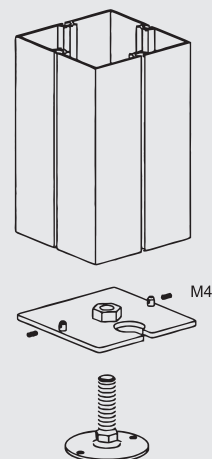

SQUARE EXTRUSIONS

BASE PLATE FOR
ADJUSTABLE FOOT

plastic, black
for adjustable foot M 285
Attention:
increases total height by 6 mm
0.051 kg

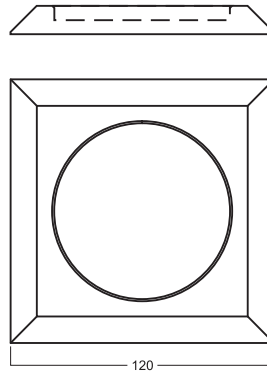

M 1057

120 MM

M 1057.33

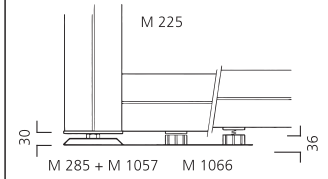

ADJUSTABLE FOOT

aluminium
for additional mounting to square
extrusions
0.113 kg

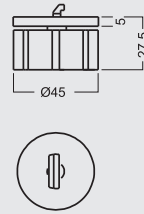

M 1066

M 1066.01

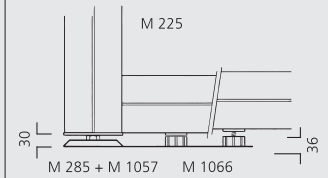

ROUND EXTRUSIONS

ROUND EXTRUSION 40 MM

aluminium
tension lock Z 961/8 can be mounted in
2 positions
5000 mm long
5.25 kg

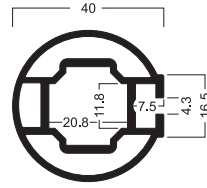
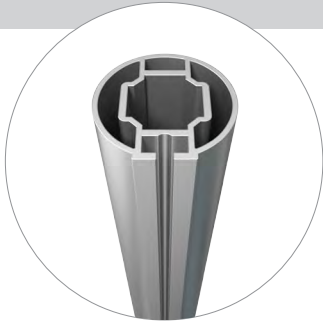

M 1201

40 MM

M 1201.01

ROUND EXTRUSION 40 MM

aluminium
tension lock Z 961/8 can be mounted in
2 positions
5000 mm long
6.1 kg

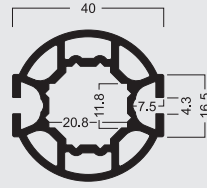

M 1202

M 1202.01

ROUND EXTRUSION 40 MM

aluminium
tension lock Z 961/8 can be mounted in
2 positions
5000 mm long
5.59 kg

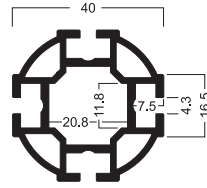
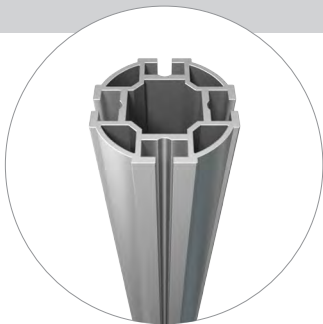

M 1204

M 1204.01

END PLATE

aluminium
incl. threaded plug S 137/K
for all round extrusions 40 mm dia.
0.036 kg

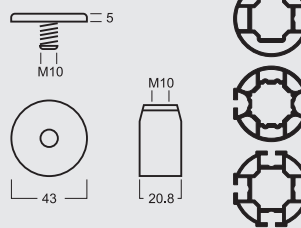
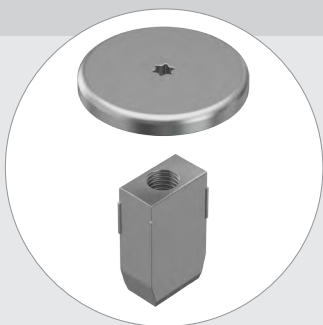

M 1215

M 1215.21

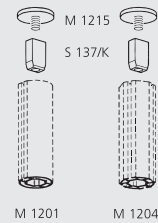

MAXIMA LIGHT

ROUND EXTRUSIONS

ADJUSTABLE FOOT

steel/aluminium
thread M10, incl. threaded plug S 137/K
for all round extrusions 40 mm dia.
0.14 kg

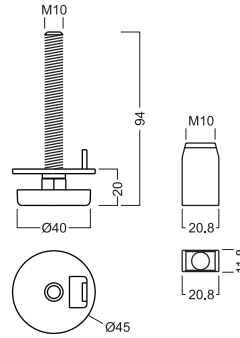

M 1216

40 MM

M 1216.37

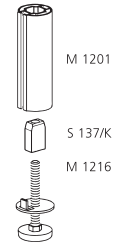

ROUND EXTRUSION 60 MM

aluminium
5000 mm long
6.755 kg

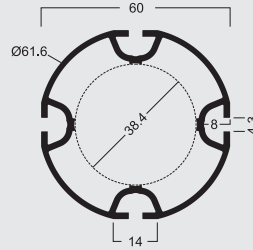
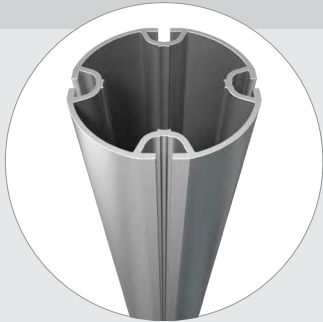

M 1210

60 MM

M 1210.01

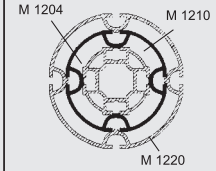

END PLATE

steel
incl. 2 set screws M 1075/20 (M4)
for round extrusion 60 mm dia.
0.073 kg

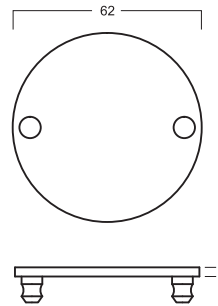

M 1231

M 1231.21

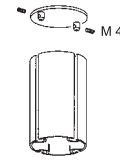

ADJUSTABLE FOOT

steel
thread M10
incl. 2 set screws M 1075/20 (M4)
for round extrusion 60 mm dia.
0.207 kg

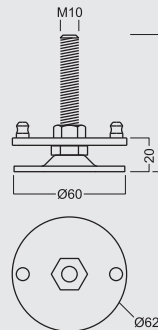
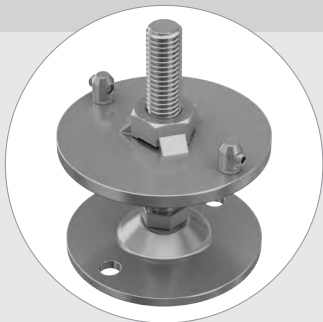

M 1232

M 1232.37

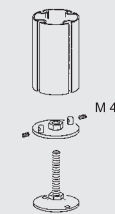

ROUND EXTRUSIONS

ROUND EXTRUSION 80 MM

aluminium
5000 mm long
9.5 kg

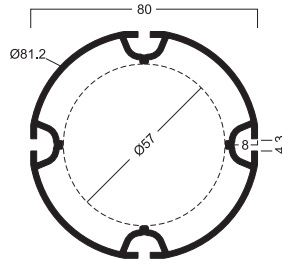

M 1220

80 MM

M 1220.01

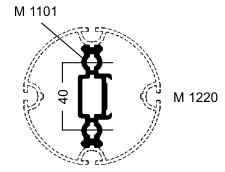

ROUND EXTRUSION 80 MM

aluminium
5000 mm long
10.97 kg

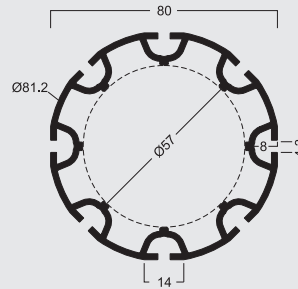
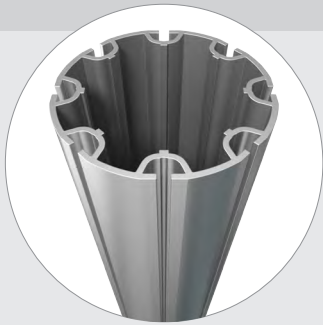

M 1222

M 1222.01

END PLATE

steel
incl. 2 set screws M 1075/20 (M4)
for all round extrusions 80 mm dia.
0.128 kg

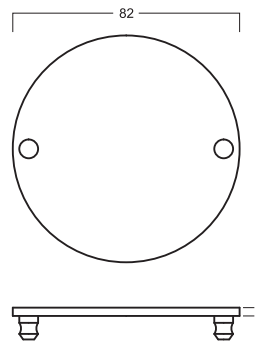

M 1235

M 1235.21

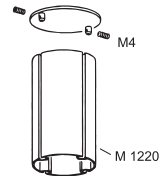

ADJUSTABLE FOOT

steel
thread M10
incl. 2 set screws M 1075/20 (M4)
for all round extrusions 80 mm dia.
0.264 kg

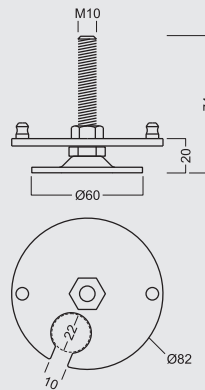
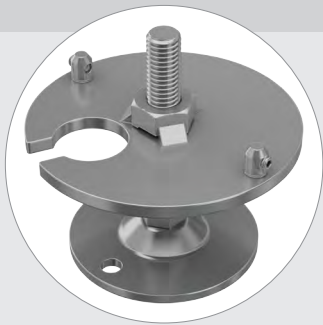

M 1234

M 1234.37

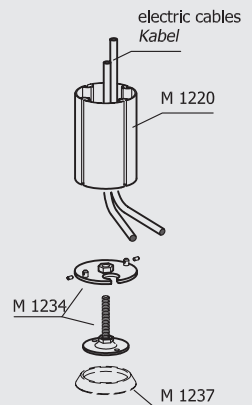

ROUND EXTRUSIONS

BASE PLATE FOR ADJUSTABLE FOOT

plastic, black
for adjustable foot M 1234
Attention:
increases total height by 6 mm
0.018 kg

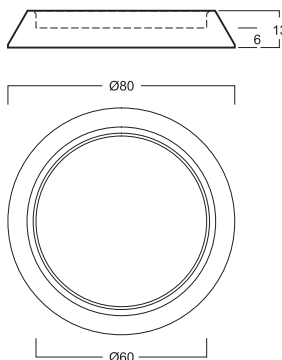

M 1237

80 MM

M 1237.33

ROUND EXTRUSION 120 MM

aluminium
5000 mm long
17.88 kg

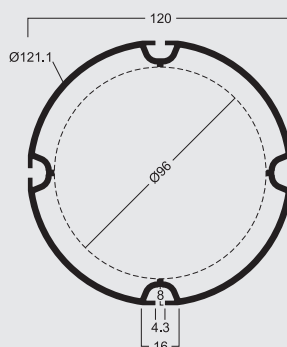

M 235

120 MM

M 235.01

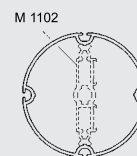

ROUND EXTRUSION 120 MM

aluminium
6000 mm long
21.42 kg

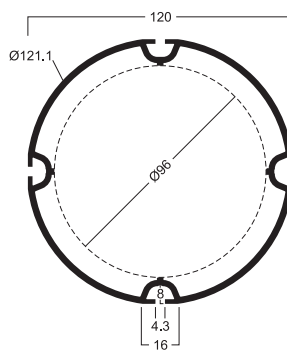

M 236

M 236.01

ROUND EXTRUSION 120 MM

aluminium
6930 mm long
24.7 kg

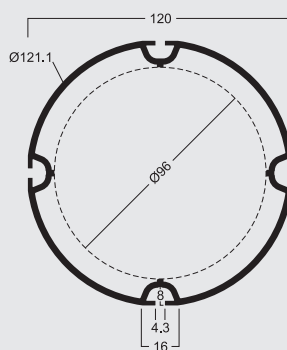

M 237

M 237.01

ROUND EXTRUSIONS

ROUND EXTRUSION
120 MM - 60°

aluminium
5000 mm long
19.22 kg

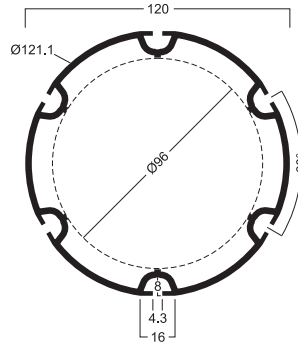

M 245

M 245.01

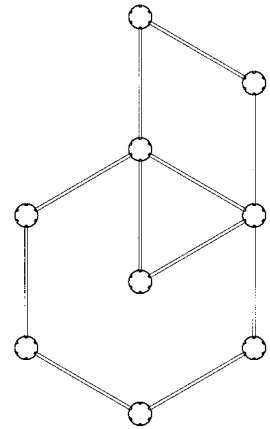

ROUND EXTRUSION 120 MM

aluminium
5000 mm long
20.55 kg

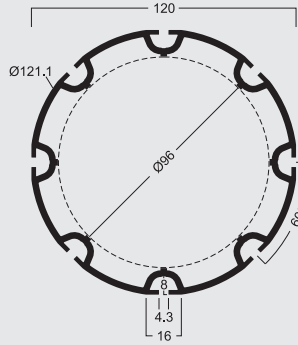
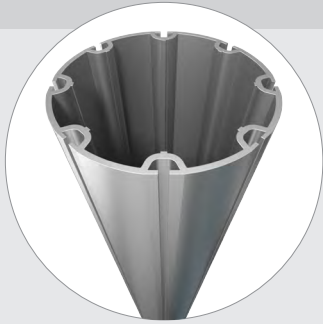

M 205

M 205.01

ROUND EXTRUSION 120 MM

aluminium
6000 mm long
24.61 kg

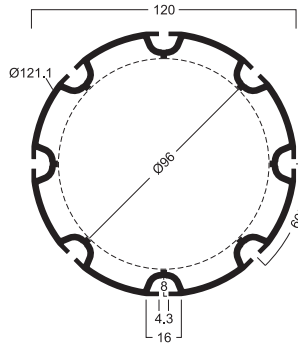
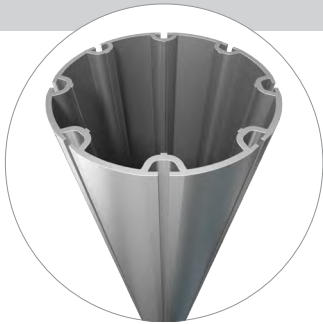

M 206

M 206.01

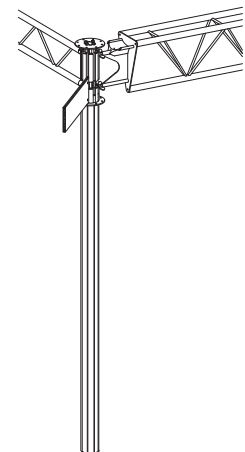

ROUND EXTRUSIONS

ROUND EXTRUSION 120 MM

aluminium
6930 mm long
 28.39 kg

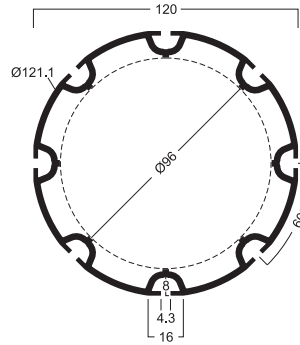
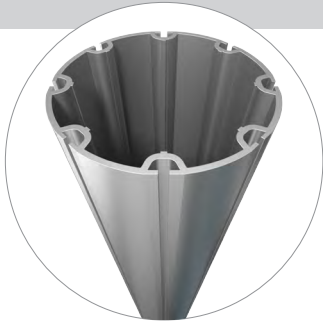

M 207

120 MM

M 207.01

ROUND EXTRUSION
 "OPEN" 120 MM

aluminium
 incl. removable cover M 215/A,
 8 reinforcement extrusions M 262, each
 80 mm long,
 16 fixing clips E 470/C,
 2 round cords M 264, each 5000 mm long
 5000 mm long
 23.757 kg

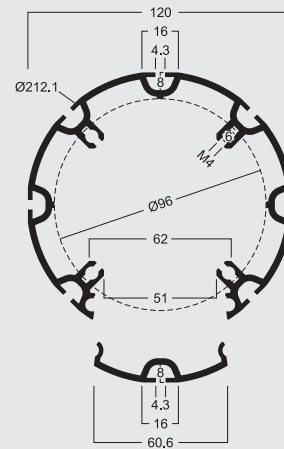
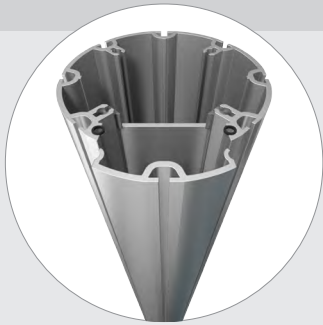

M 215

120 MM OPEN

M 215.01

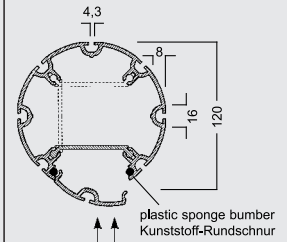

ROUND EXTRUSION
 "OPEN" 120 MM

aluminium
 incl. removable cover M 216/A,
 8 reinforcement extrusions M 262, each
 80 mm long,
 16 fixing clips E 470/C,
 2 round cords M 265, each 6000 mm long
6000 mm long
 28.421 kg

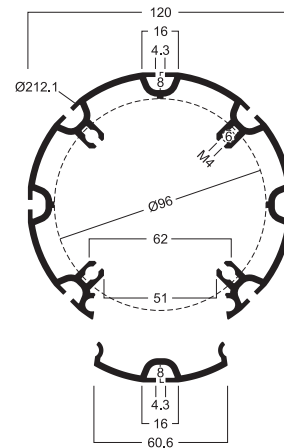
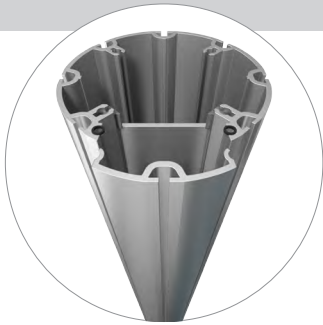

M 216

M 216.01

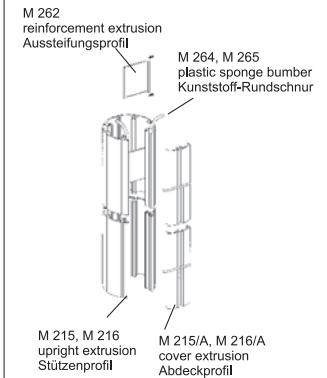

ROUND EXTRUSIONS

ROUND EXTRUSION
"OPEN" 120 MM

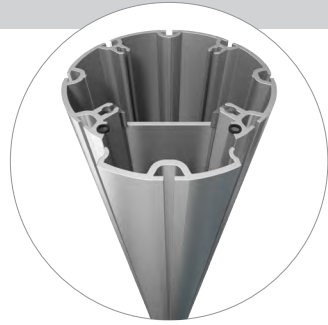

aluminium
incl. removable cover M 217/A,
9 reinforcement extrusions M 262, each
80 mm long,
18 fixing clips E 470/C,
3 round cords M 264, each 5000 mm long
6930 mm long
32.776 kg

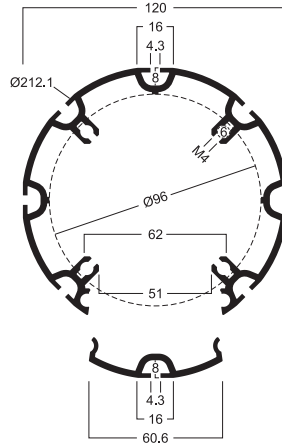

M 217

M 217.01

COVER EXTRUSION,
TRANSLUCENT



frosted acrylic
for internal illumination of open round
extrusion 120 mm dia.
5020 mm long
0.745 kg

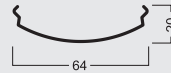

M 220

M 220.50

END PLATE

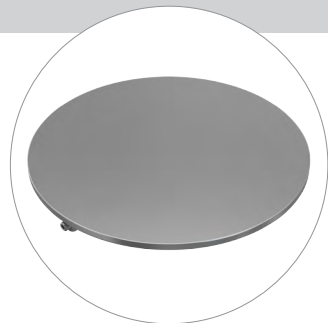

steel
incl. 2 set screws M 1075/20 (M4)
for all round extrusions 120 mm dia.
0.277 kg

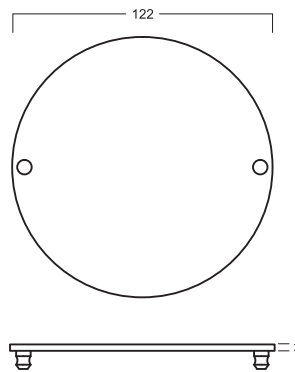

M 270

M 270.21

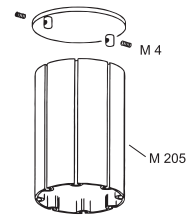

ROUND EXTRUSIONS

ADJUSTABLE FOOT

steel
 thread M16
 incl. 2 set screws M 1075/20 (M4)
 for all round extrusions 120 mm dia.
 0.67 kg

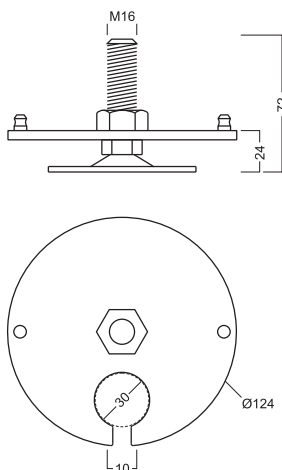

M 282

120 MM OPEN

M 282.37

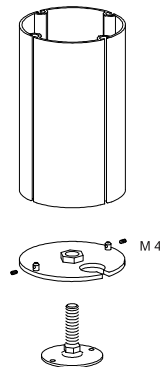

RECTANGULAR EXTRUSIONS

BEAM EXTRUSION 40 X 16 MM

aluminium
tension lock Z 961/13 can be mounted
5000 mm long
3.38 kg

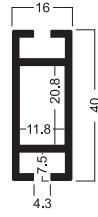

Z 4400

40 X 16 MM

Z 4400.01

BEAM EXTRUSION 80 X 16 MM

aluminium
2 tension locks Z 961/13 can be mounted
5000 mm long
6.45 kg

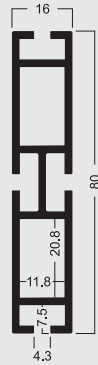

M 1320

80 X 16 MM

M 1320.01

BEAM EXTRUSION 120 X 16 MM

aluminium
2 tension locks Z 961/13 can be mounted
5000 mm long
9 kg



M 1340

120 X 16 MM

M 1340.01

RECTANGULAR EXTRUSION 40 X 28 MM

aluminium
tension lock Z 961/8 can be mounted
5000 mm long
4.756 kg

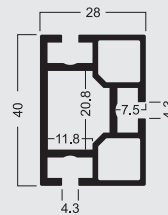
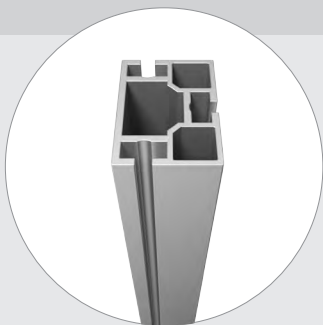

M 1068

40 X 28 MM

M 1068.01

MAXIMA LIGHT

RECTANGULAR EXTRUSIONS

RECTANGULAR EXTRUSION 40 X 28 MM

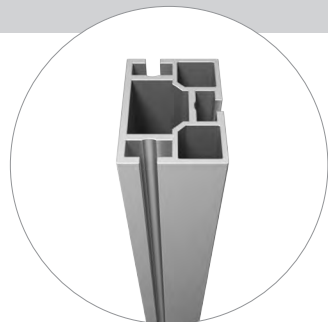

aluminium
tension lock Z 961/8 can be mounted
6000 mm long
5.707 kg

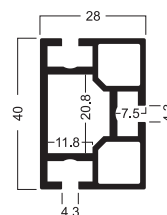

M 1069 40 X 28 MM

M 1069.01

RECTANGULAR EXTRUSION 60 X 40 MM

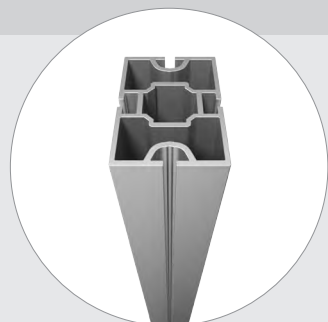

aluminium
tension lock Z 961/8 can be mounted in
2 positions
6000 mm long
10.732 kg

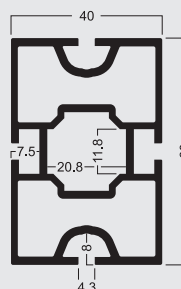

M 1082 60 X 40 MM

M 1082.01

END PLATE



steel
incl. 2 set screws M 1075/20 (M4)
for rectangular extrusion M 1081, M 1082
0.061 kg

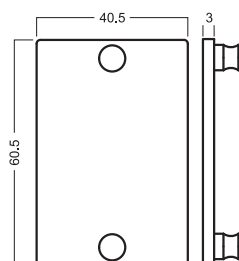

M 1099

M 1099.21

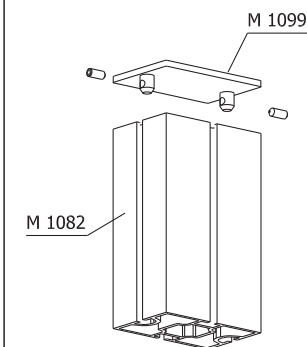

RECTANGULAR EXTRUSION 80 X 40 MM



aluminium
tension lock Z 961/8 can be mounted in
2 positions
5000 mm long
10.57 kg

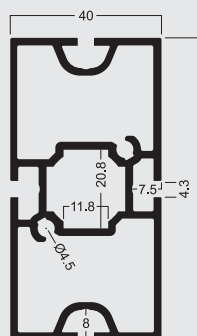

M 1025 80 X 40 MM

M 1025.01

RECTANGULAR EXTRUSIONS

RECTANGULAR EXTRUSION 80 X 40 MM

aluminium
tension lock Z 961/8 can be mounted in 2 positions
6000 mm long
12.7 kg

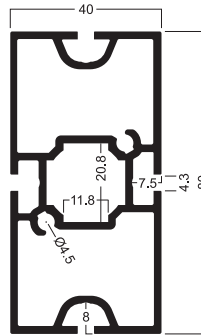

M 1026

M 1026.01

RECTANGULAR EXTRUSION 80 X 40 MM

aluminium
up to 2 tension locks Z 961/8 can be mounted
5000 mm long
12.164 kg

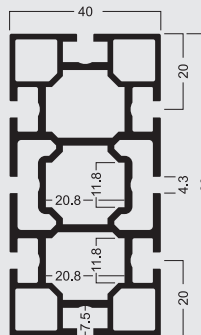

M 1091

M 1091.01

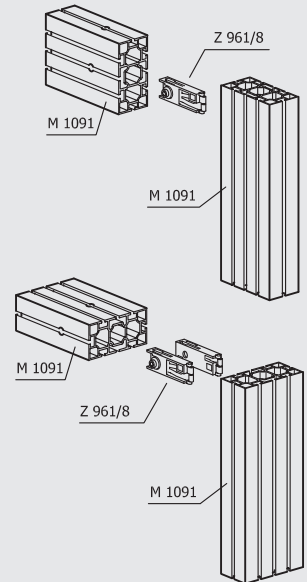

RECTANGULAR EXTRUSION 80 X 40 MM

aluminium
up to 2 tension locks Z 961/8 can be mounted
6000 mm long
14.597 kg

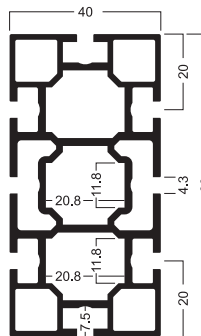
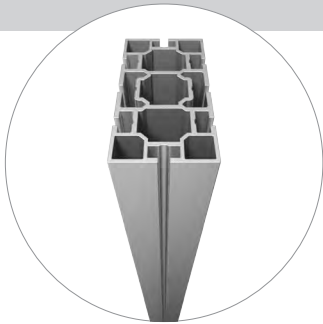

M 1092

M 1092.01

MAXIMA LIGHT

RECTANGULAR EXTRUSIONS

END PLATE

steel
incl. 2 set screws M 1075/20 (M4)
for rectangular extrusions 80 x 40 mm
0.079 kg

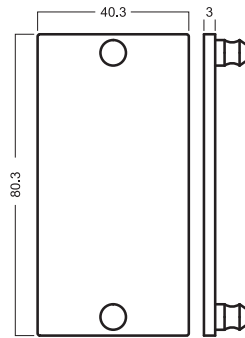

M 1085

80 X 40 MM

M 1085.21

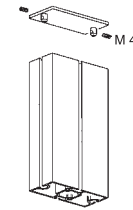

ADJUSTABLE FOOT

steel
thread M8
incl. 2 set screws M 1075/20 (M4)
for rectangular extrusions 80 x 40 mm
0.172 kg

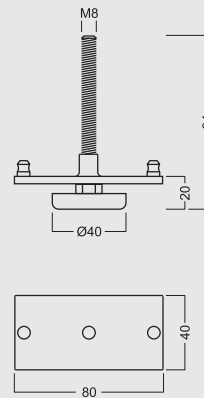
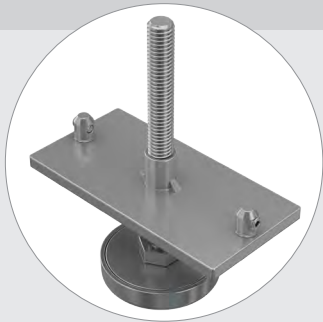

M 1086

M 1086.37

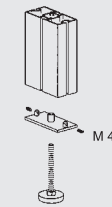

RECTANGULAR EXTRUSION 120 X 40 MM

aluminium
tension lock Z 961/8 can be mounted in
2 positions
5000 mm long
15.054 kg

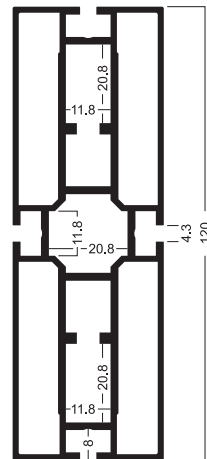
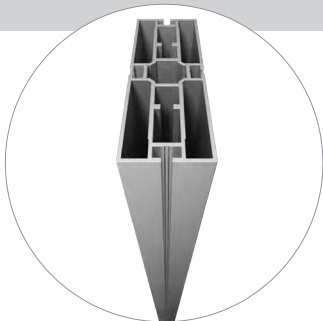

M 1030

120 X 40 MM

M 1030.01

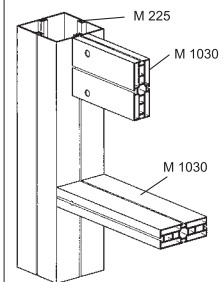

RECTANGULAR EXTRUSIONS

RECTANGULAR EXTRUSION 120 X 40 MM

aluminium
tension lock Z 961/8 can be mounted in 2 positions
6000 mm long
18.065 kg

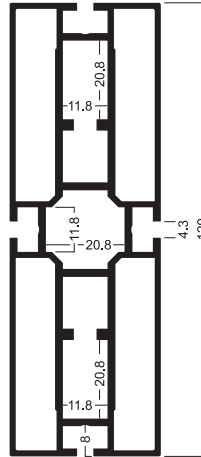
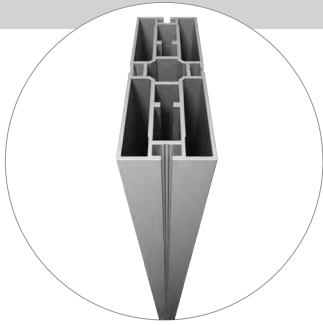

M 1031

M 1031.01

END PLATE

steel
incl. 2 set screws M 1075/20 (M4)
for rectangular extrusion M 1030
0.12 kg

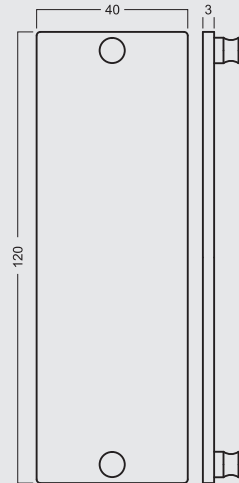
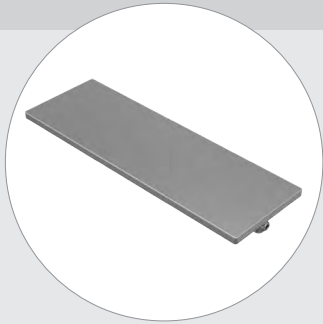

M 1087

M 1087.21

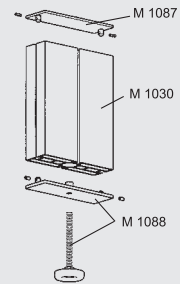

ADJUSTABLE FOOT

steel
thread M8
incl. 2 set screws M 1075/20 (M4)
for rectangular extrusion M 1030
0.236 kg

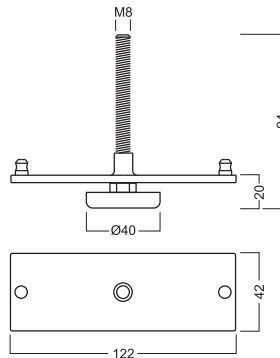
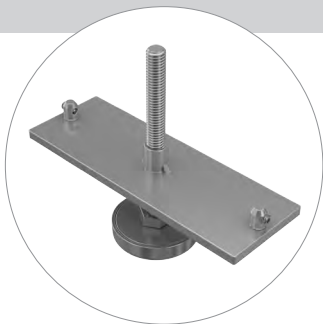

M 1088

M 1088.37

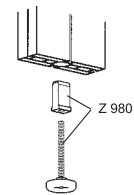

MAXIMA LIGHT

RECTANGULAR EXTRUSIONS

RECTANGULAR EXTRUSION "OPEN" 120 X 60 MM

aluminium
2 tension locks Z 961/13 and reinforcement extrusion M 1110 can be mounted
5000 mm long
12.94 kg

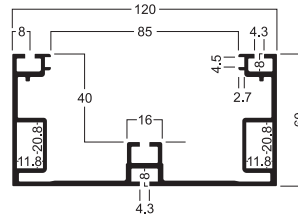
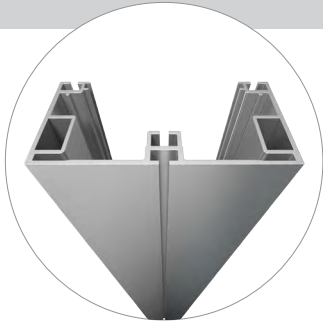

M 1060

120 X 60 MM

M 1060.01

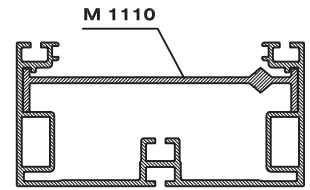

RECTANGULAR EXTRUSION 160 X 80 MM

aluminium
adaptor with tension lock M 1103 can be mounted
6930 mm long
30.6 kg

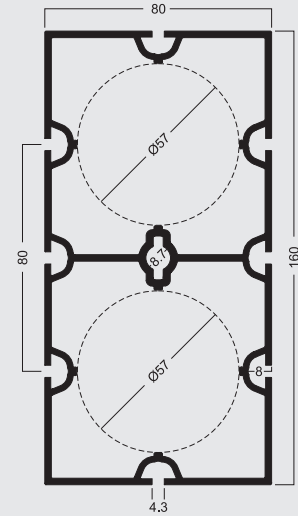
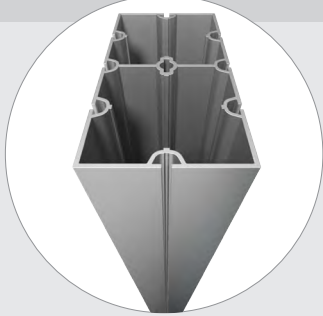

M 1052

160 X 80 MM

M 1052.01

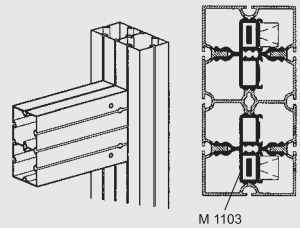

END PLATE

steel
incl. 2 set screws M 1075/20 (M4)
for rectangular extrusion M 1052
0.303 kg

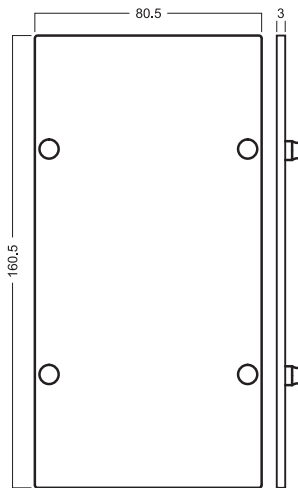

M 1097

M 1097.21

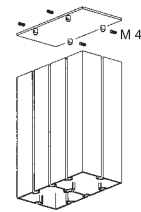

ADJUSTABLE FOOT

M 1098

steel
thread M10
incl. 2 set screws M 1075/20 (M4)
for rectangular extrusion M 1052
0.536 kg

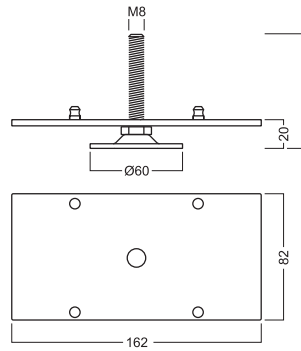

M 1098.37

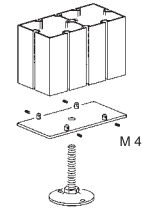

MAXIMA LIGHT

OVAL BEAMS

ELLIPTICAL EXTRUSION 80 X 40 MM

aluminium
tension lock Z 961/8 can be mounted in
2 positions
5000 mm long
9.59 kg

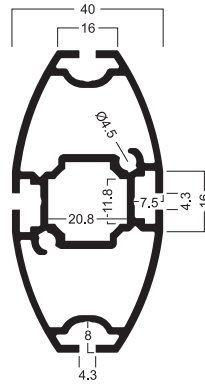

M 1225

80 X 40 MM

M 1225.01

END PLATE

steel
incl. 2 set screws M 1075/20 (M4)
for elliptical extrusion M 1225
0.069 kg

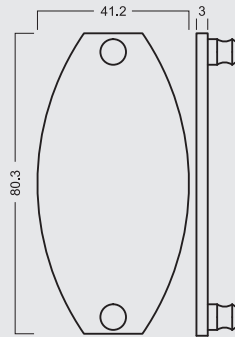

M 1245

M 1245.21

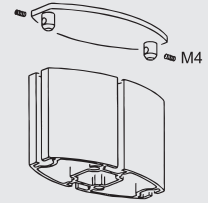

ADJUSTABLE FOOT

steel
thread M8
incl. 2 set screws M 1075/20 (M4)
for elliptical extrusion M 1225
0.16 kg

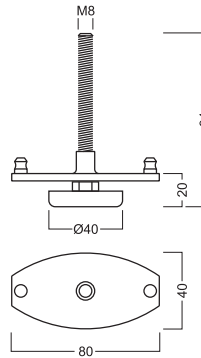

M 1246

M 1246.37

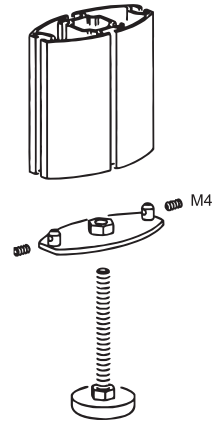

OVAL BEAMS

ELLIPTICAL EXTRUSION
120 X 40 MM

aluminium
tension lock Z 961/8 can be mounted in
4 positions
5000 mm long
11.011 kg

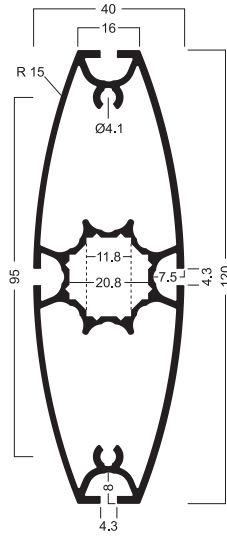
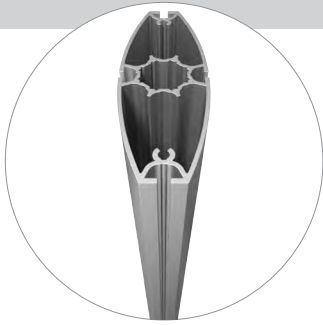

M 1227

120 X 40 MM

M 1227.01

OVAL EXTRUSION
"OPEN" 230 X 40 MM

aluminium
5000 mm long
11.53 kg

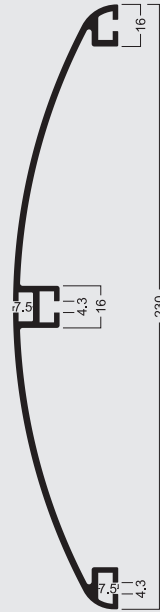

S 2305

230 X 40 MM

S 2305.01

OVAL BEAMS

END PLATE

steel
incl. 3 set screws E 111/4*8 (M4)
for oval extrusion S 2305
0.245 kg

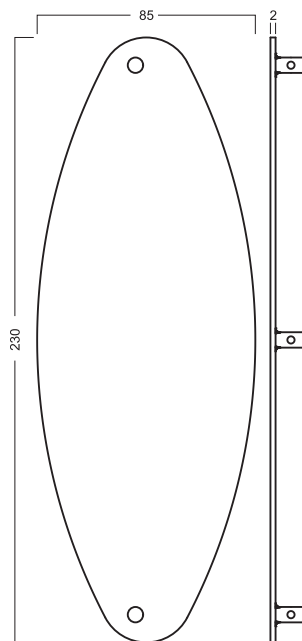
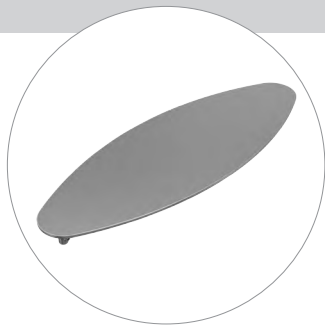

S 2330

230 X 40 MM

S 2330.21

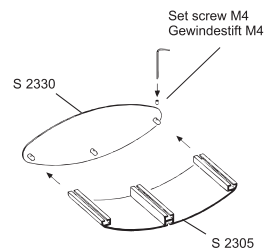

ADAPTORS

ADAPTOR WITH TENSION LOCK

aluminium
incl. 1 tension lock Z 961/13 and
2 countersunk screws M 1100/20 (M5)
for all square and round extrusions **60 mm**
0.121 kg

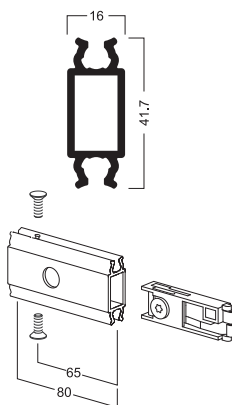
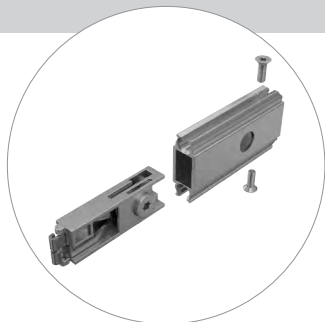

M 1100

M 1100.00

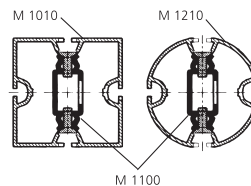

ADAPTOR WITH TENSION LOCK

aluminium
incl. 1 tension lock Z 961/13,
1 collar guide M 1102/2 and
2 countersunk screws M 1100/20 (M5)
for all square and round extrusions **80 mm**
0.14 kg

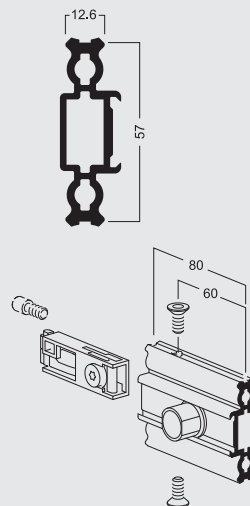
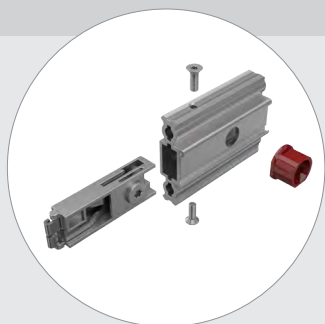

M 1101

M 1101.00

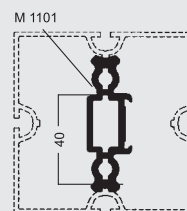

ADAPTOR WITH TENSION LOCK

aluminium
incl. 2 tension locks Z 961/13,
2 collar guides M 1102/2 and
2 countersunk screws M 1100/20 (M5)
for open square extrusions **80 mm**
0.277 kg

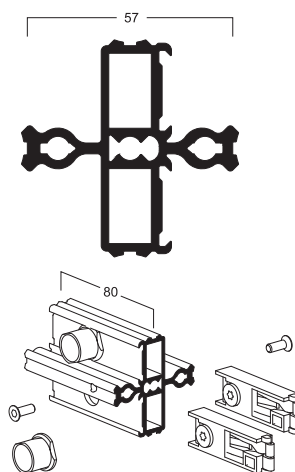
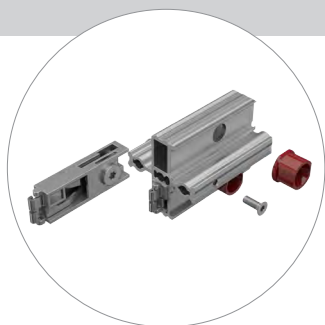

M 1103

M 1103.00

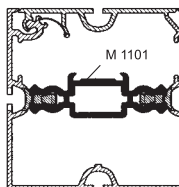
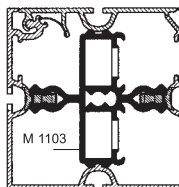

ADAPTORS

BEAM RETAINER

steel
for adaptor with tension lock
M 1101 and M 1103
27 mm long
0.01 kg

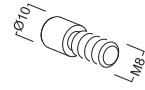

M 1108

M 1108.37

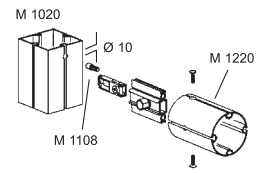

ADAPTOR WITH TENSION LOCK

aluminium
incl. 1 tension lock Z 961/13,
1 collar guide M 1102/2 and
2 countersunk screws M 1611/20
has to be used in combination with M 1285
or M 1286
for round extrusions **80 mm dia.**
0.176 kg

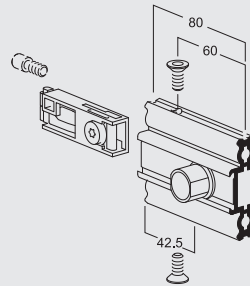
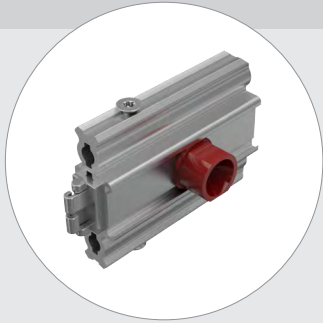

M 1291

M 1291.03

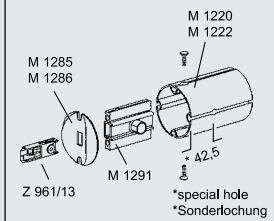

ADAPTOR

plastic
in conjunction with adaptor M 1291 or
hinged flange plate M 1271
for connecting round extrusions
80 mm dia. with 80 mm dia.
0.04 kg

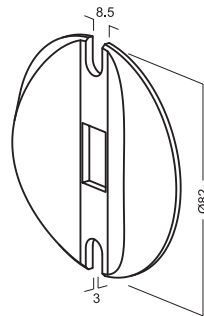

M 1285

M 1285.33

ADAPTORS

ADAPTOR

plastic
in conjunction with adaptor M 1291 or
hinged flange plate M 1271
for connecting round extrusions
80 mm dia. with 120 mm dia.
0.035 kg

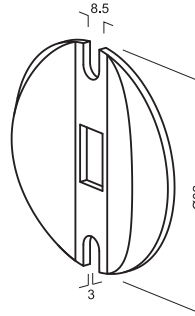

M 1286

M 1286.33

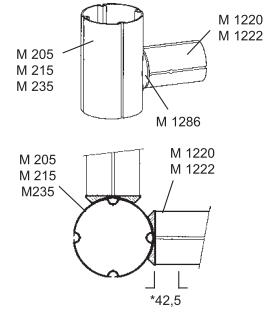

ADAPTOR WITH
SAFETY TENSION LOCK

aluminium
incl. 1 safety tension lock M 1161/L,
1 collar guide M 1102/2 and
4 countersunk screws M 1611/20
for all square and round extrusions **80 mm**
0.221 kg

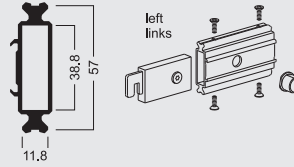
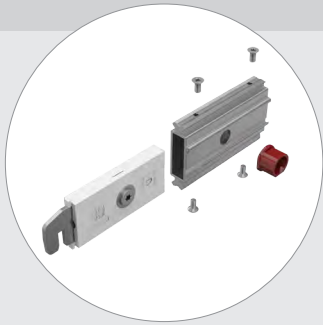

M 1116

M 1116.00

ADAPTOR WITH
SAFETY TENSION LOCK

aluminium
incl. 1 safety tension lock M 1161/R,
1 collar guide M 1102/2 and
4 countersunk screws M 1611/20 (M5)
for all square and round extrusions **80 mm**
0.221 kg

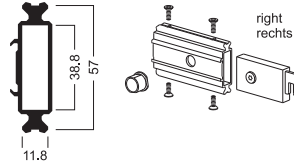

M 1114

M 1114.00

M 1114 / M 1116 for extrusions:
M 1114 / M 1116 für Profile:

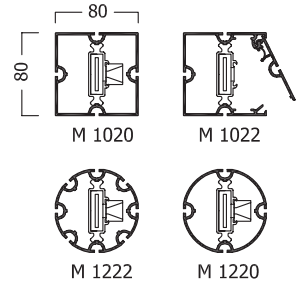

ADAPTORS

ADAPTOR WITH TENSION LOCK

aluminium
incl. 2 tension locks Z 961/13,
1 knurled-head screw M 1102/21 (M4) for
beam retainer M 1106,
2 collar guides M 1102/2 and
4 countersunk screws M 1102/20 (M6)
for all closed square and round extrusions
120 mm
0.323 kg

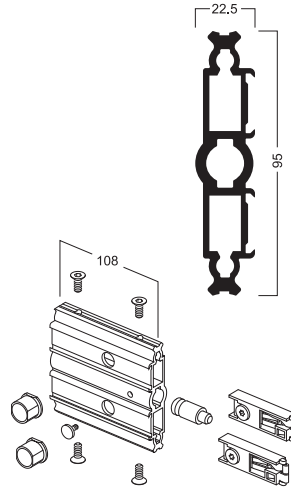

M 1102

M 1102.00

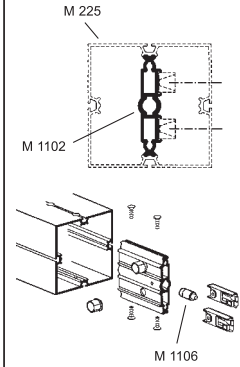

BEAM RETAINER

aluminium
2 parts, incl. set screw M 1105/20 (M4)
for mounting to system groove 4.3 mm
**Attention: Beam retainer has to be used
for safety reasons and to facilitate the
assembly of the beam extrusions!**
0.06 kg

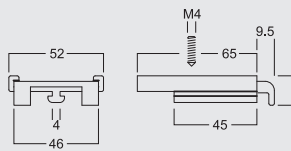
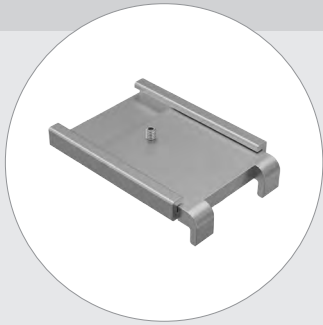

M 1105

M 1105.00

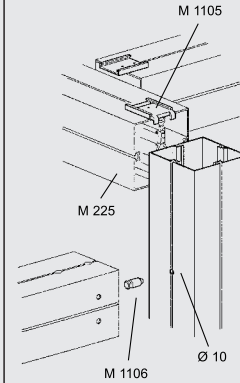

BEAM RETAINER

steel
for M 1102, M 1104/L and M 1104/R
38 mm long
0.036 kg

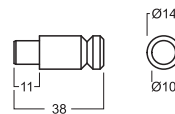

M 1106

M 1106.37

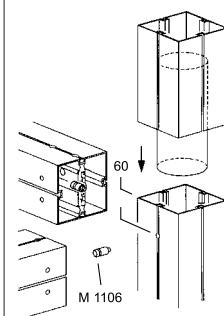

ADAPTORS

ADAPTOR WITH TENSION LOCK

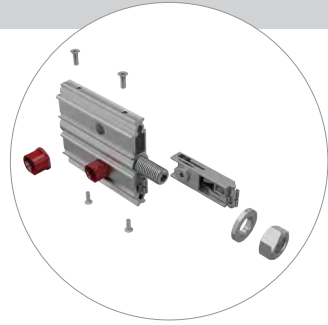

aluminium,
incl. 2 tension locks Z961/13
1 set screw M 1122/20 (M16)
1 washer M 1122/2, 1 nut M 551/31 (M16)
2 collar guides and 4 countersunk screws
M 1102/20 (M6)
for all square extrusions 120 mm
in conjunction with M 230
0.524 kg

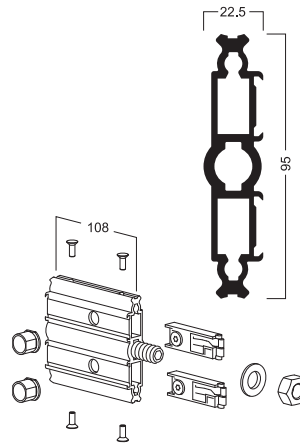

M 1122

M 1122.00

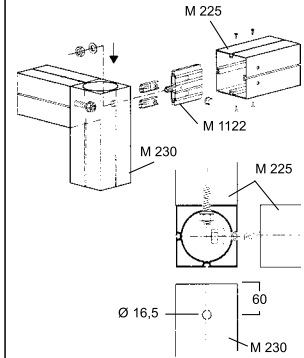

ADAPTOR WITH TENSION LOCK

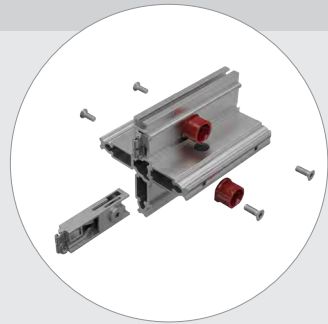

aluminium
incl. 2 tension locks Z 961/13
1 set screw M 1104/21 (M6) for M 1106
2 collar guides M 1102/2
and 4 countersunk screws M 1102/20 (M6)
for all open square extrusions 120 mm
0.551 kg

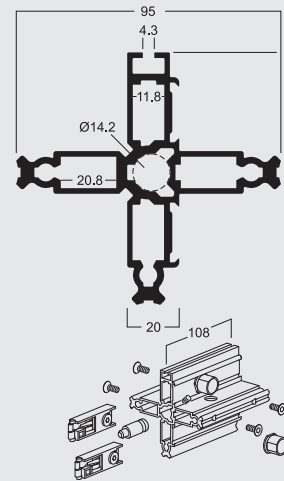

M 1104/L

M 1104/L.00

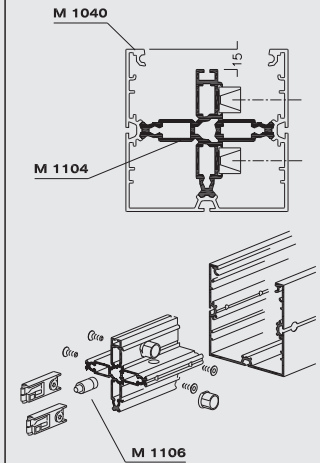

ADAPTOR WITH TENSION LOCK

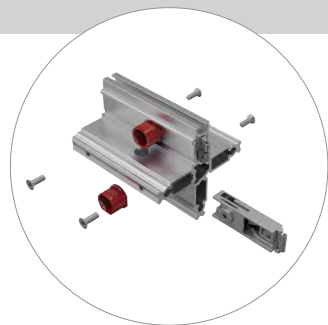

aluminium
incl. 2 tension locks Z 961/13
1 set screw M 1104/21 (M6) for M 1106
2 collar guides M 1102/2
and 4 countersunk screws M 1102/20 (M6)
for all open square extrusions 120 mm
0.551 kg

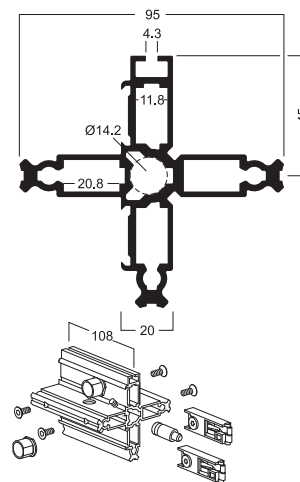

M 1104/R

M 1104/R.00

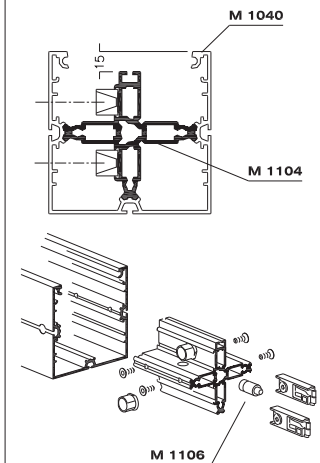

ADAPTORS

BEAM RETAINER

steel, zinc-plated
to be used with extrusions M 1040, M 1041
Attention: Beam retainer has to be used for safety reasons and to facilitate the assembly of the beam extrusions!
0.168 kg

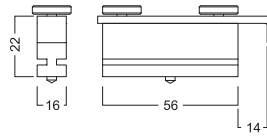
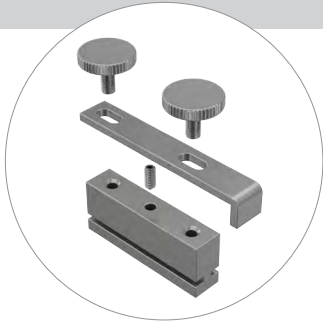

M 1125

M 1125.37

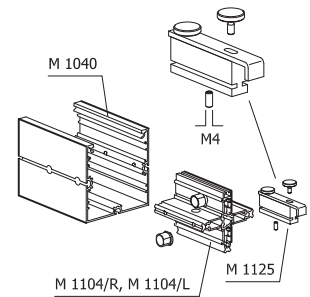

ADAPTOR WITH SAFETY TENSION LOCK

aluminium
incl. 2 safety tension locks M 1161/R,
2 collar guides M 1102/2 and
4 countersunk screws M 1124/20 (M6)
for all square and round extrusions
120 mm
0.394 kg

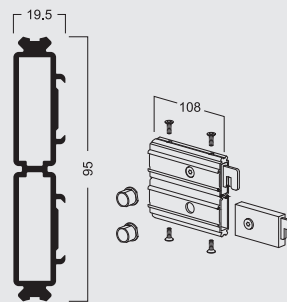
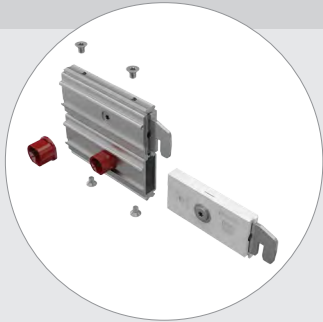

M 1124

M 1124.00

M 1124 / M 1126 for extrusions:
M 1124 / M 1126 für Profile:

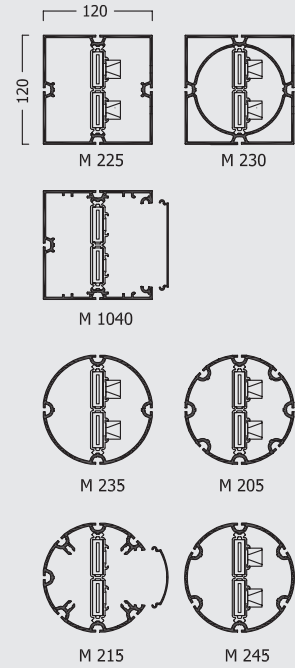

ADAPTOR WITH SAFETY TENSION LOCK

aluminium
incl. 2 safety tension locks M 1161/L,
2 collar guides M 1102/2 and
4 countersunk screws M 1124/20 (M6)
for all square and round extrusions
120 mm
0.394 kg

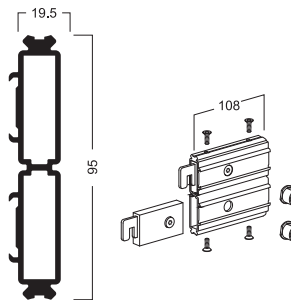
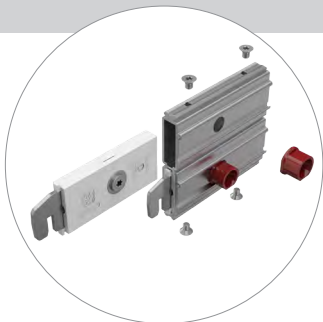

M 1126

M 1126.00

ADAPTORS

SAFETY TENSION LOCK, LEFT

plastic/steel
for extrusions with lock chamber
39 x 12 mm
0.088 kg

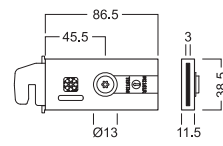

M 1161/L

M 1161/L.90

SAFETY TENSION LOCK, RIGHT

plastic/steel
for extrusions with lock chamber
39 x 12 mm
0.088 kg

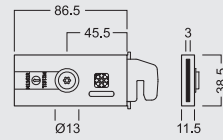

M 1161/R

M 1161/R.90

END PLATES FOR TELESCOPIC SOLUTIONS

END PLATE

steel
incl. 2 set screws M 1075/20 (M4)
for square extrusion M 1010, M 1011
0.068 kg

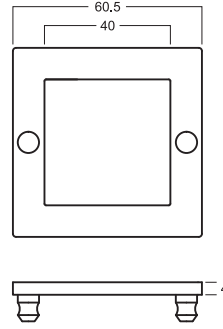
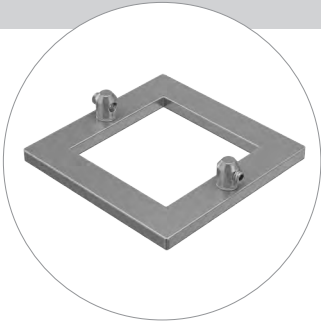

M 1461

M 1461.21

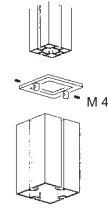

END PLATE

steel
incl. 2 set screws M 1075/20 (M4)
for square extrusion M 1020, M 1021
0.096 kg

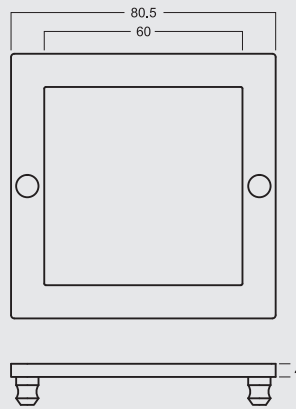
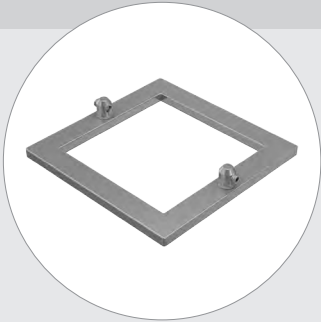

M 1465

M 1465.21

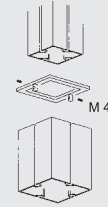

END PLATE

steel
incl. 2 set screws M 1075/20 (M4)
for round extrusion M 1210
0.057 kg

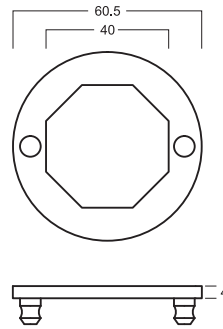
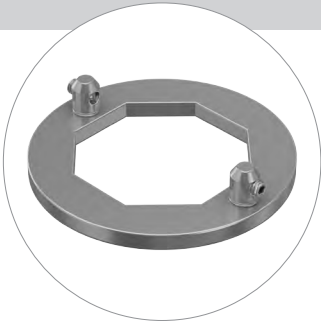

M 1462

M 1462.21

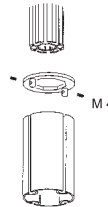

END PLATE

steel
incl. 2 set screws M 1075/20 (M4)
for round extrusion M 1220
0.076 kg

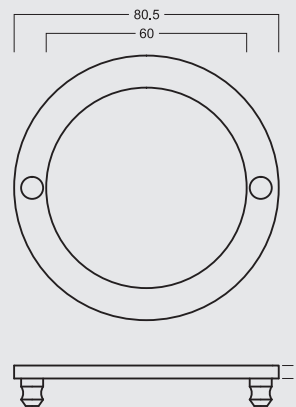

M 1466

M 1466.21

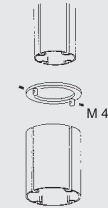

CLAMPING SET

M 1469

steel
for telescopic solutions
with M 1461, M 1462, M 1465, M 1466
0.034 kg

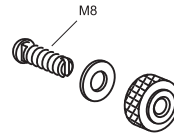

M 1469.37

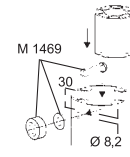

HINGED END PLATES

HINGED END PLATE

steel
incl. 1 cylinder screw M 1296/20 (M6)
and 1 anti-slipping device M 1599
for all square extrusions **40 mm**
0.324 kg

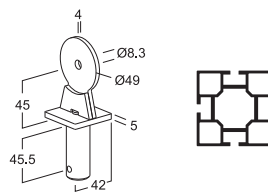

M 1541

M 1541.21

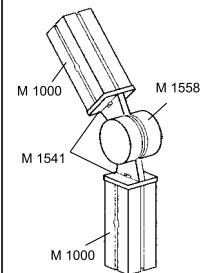

HINGED END PLATE

steel
incl. 2 cylinder screws M 1296/20 (M6)
and 1 anti-slipping device M 1599
for all extrusions **40 mm**
0.303 kg

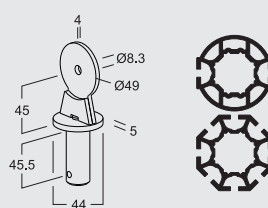

M 1540

M 1540.21

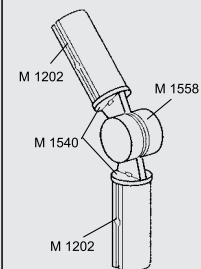

HINGED END PLATE

steel
incl. 2 countersunk screws M 1250/20 (M8)
and 1 anti-slipping device M 1599
for all square extrusions **60 mm**
0.257 kg

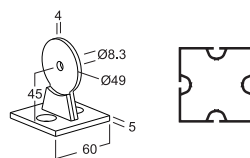
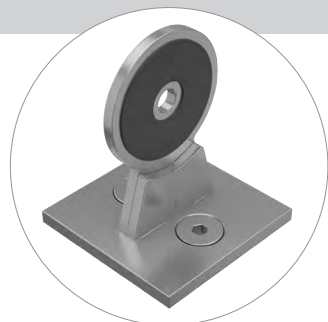

M 1551

M 1551.21

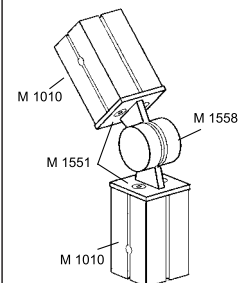

HINGED END PLATE

steel
incl. 2 countersunk screws M 1250/20 (M8)
and 1 anti-slipping device M 1599
for all round extrusions **60 mm**
0.225 kg

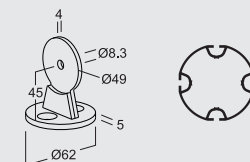
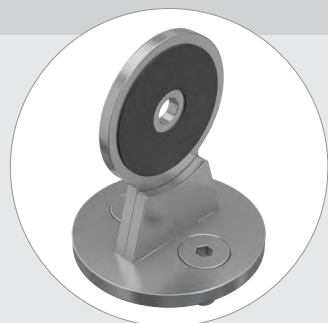

M 1550

M 1550.21

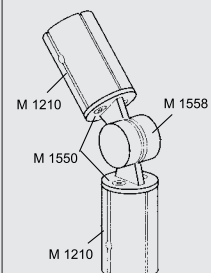

HINGED END PLATES

ADAPTOR FOR HINGED END PLATE

aluminium
with 2 threads M8
incl. 2 countersunk screws M 1100/20 (M5)
for all square and round extrusions 60 mm
0.069 kg

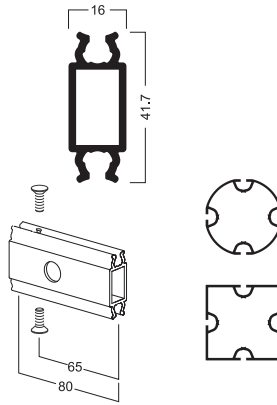
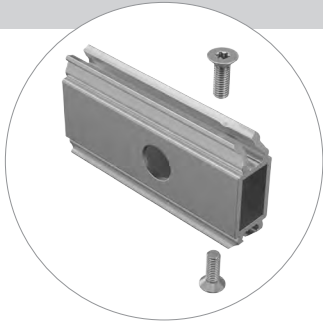

M 1555

M 1555.00

HINGED FLANGE PLATE

steel
incl. 1 round head screw with flange
M 1557/20 (M6)
2 set screws M 1435/20 (M8)
and 1 anti-slipping device M 1599
for mounting to system groove 4.3 mm
for all hinged end plates and
hinged flange plates with 49 mm dia.
0.113 kg

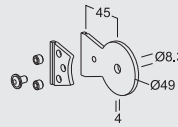
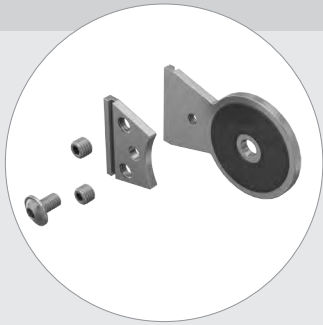

M 1557

M 1557.21

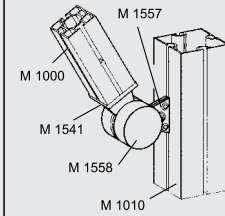

COVER CYLINDER SET

plastic, light grey
incl. treaded steel rod M8
for all hinged end plates and
hinged flange plates with 49 mm dia.
0.091 kg

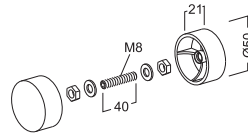

M 1558

M 1558.35

HINGED END PLATE WITH EYELET

steel
incl. 1 anti-slipping device M 1599
for all hinges with 49 mm dia.
0.063 kg

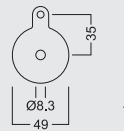

M 1579

M 1579.21

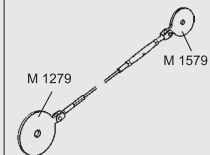

HINGED END PLATES

STEEL WIRE WITH TURNBUCKLE

stainless steel
tensile strength 4,5 kN (ca. 450 kg)
length on request

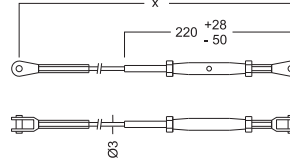

M 1280

M 1280.00

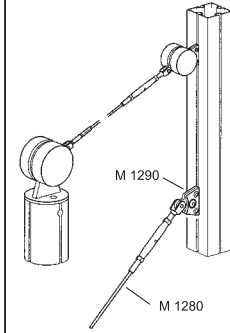

ANTI-SLIPPING DEVICE

flocked self-adhesive paper
for all hinged end plates and
hinged flange plates with 49 mm dia.

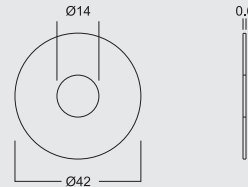

M 1599

M 1599.33

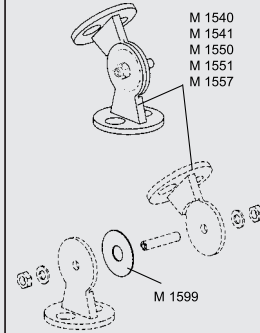

HINGED END PLATE

steel
incl. 1 anti-slipping device M 1299
for extrusion S 100
0.375 kg

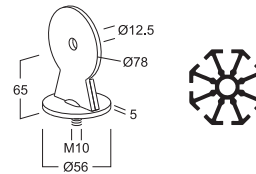

M 1295

M 1295.21

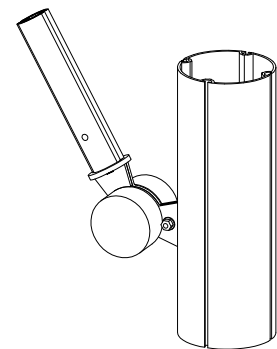

HINGED END PLATE

steel
incl. 2 cylinder screws M 1296/20 (M6)
and 1 anti-slipping device M 1299
for all extrusions 40 mm with chamber for
tension lock Z 961/8
0.52 kg

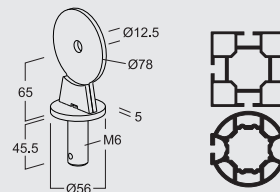

M 1296

M 1296.21

HINGED END PLATES

HINGED END PLATE

steel
incl. 2 countersunk screws M 1250/20 (M8)
and 1 anti-slipping device M 1299
for all square extrusions **80 mm**
0.538 kg

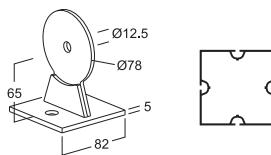
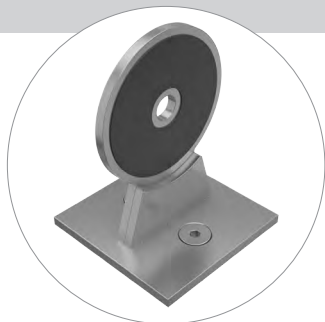

M 1260

M 1260.21

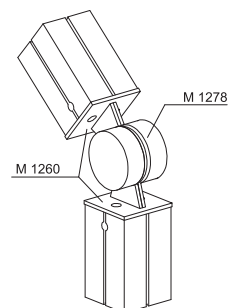

HINGED END PLATE

steel
incl. 2 countersunk screws M 1250/20 (M8)
and 1 anti-slipping device M 1299
for all round extrusions **80 mm**
0.482 kg

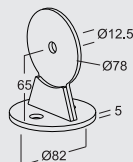
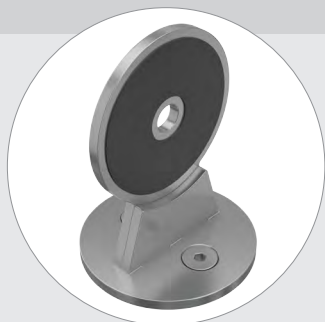

M 1250

M 1250.21

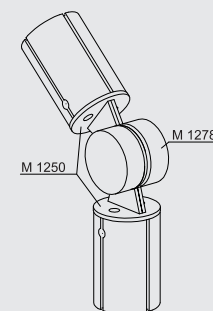

ADAPTOR FOR HINGED END PLATE

aluminium
with 2 threads M8
incl. 2 countersunk screws M 1611/20 (M5)
for all square and round extrusions **80 mm**
0.103 kg

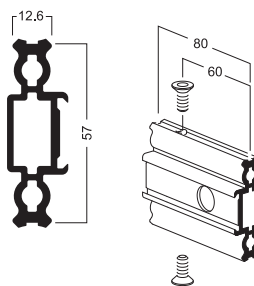

M 1281

M 1281.00

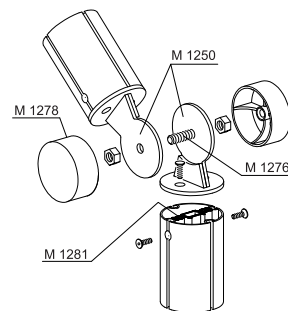

HINGED END PLATE

steel
incl. 2 countersunk screws M 1250/20 (M8)
and 1 anti-slipping device M 1299
for all square extrusions **120 mm**
0.866 kg

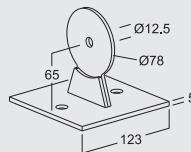
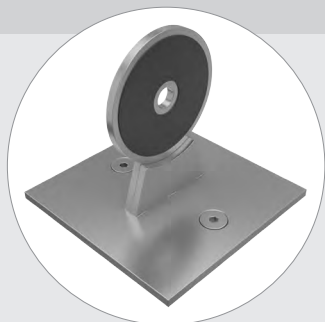

M 1265

M 1265.21

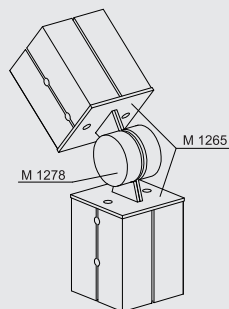

HINGED END PLATES

HINGED END PLATE

steel
incl. 2 countersunk screws M 1250/20 (M8)
and anti-slipping device M 1299
for all round extrusions **120 mm**
0.716 kg

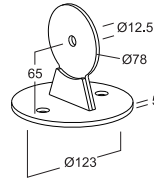
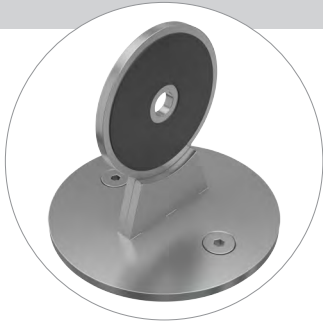

M 1255

M 1255.21

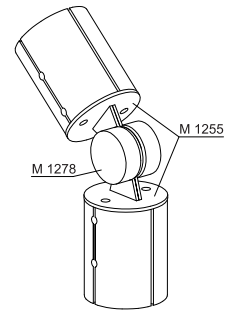

HINGED END PLATE

steel
incl. 2 countersunk screws M 1250/20 (M8)
and anti-slipping device M 1299
for all **open** round extrusions **120 mm**
0.752 kg

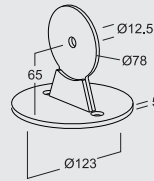
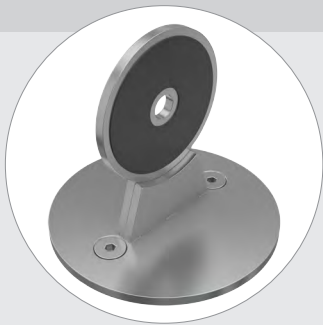

M 1258

M 1258.21

ADAPTOR FOR HINGED END PLATE

aluminium
with 2 threads M8
incl. 4 countersunk screws M 1102/20 (M6)
for all extrusions **120 mm**
0.268 kg

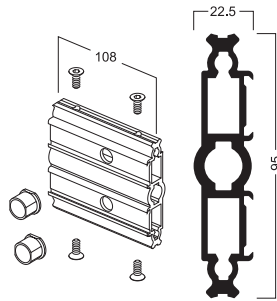
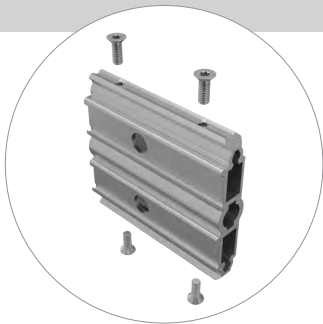

M 1282

M 1282.00

HINGED FLANGE PLATE

steel
incl. fixing screws
and 1 anti-slipping device M 1299
for mounting to system groove 4.3 mm
for all hinged end plates and
hinged flange plates with 78 mm dia.
0.314 kg

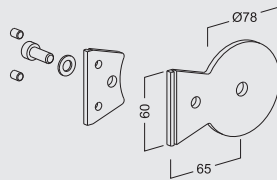
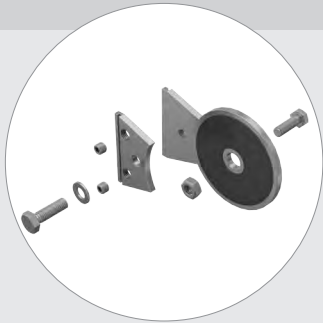

M 1270

M 1270.21

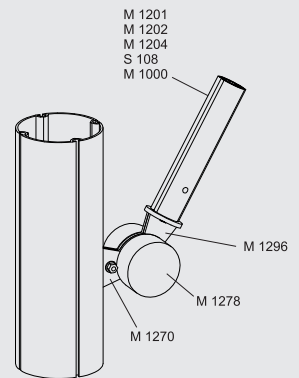

HINGED END PLATES

HINGED FLANGE PLATE



steel
incl. 2 hammerhead screws M 1472 (M8)
and 1 anti-slipping device M 1299
can be used optionally with or without
adaptor M 1285 / M 1286
0.485 kg

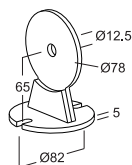

M 1271

M 1271.21

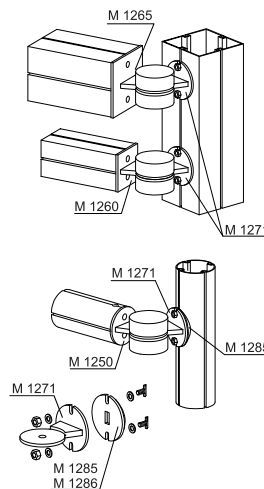

SCREW SET

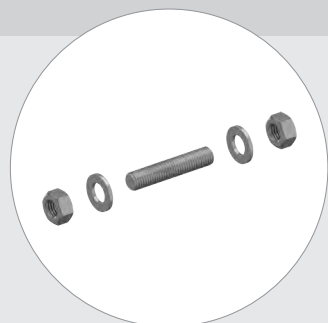

steel
for all hinged end plates and
hinged flange plates with 78 mm dia.
0.082 kg

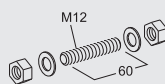

M 1276

M 1276.37

WING NUT SET

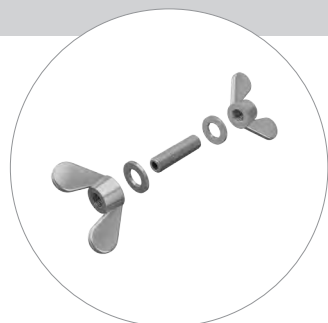

steel
for all hinged end plates and
hinged flange plates with 78 mm dia.
0.144 kg

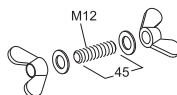

M 1277

M 1277.37

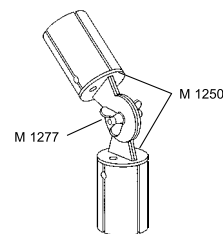

COVER CYLINDER SET

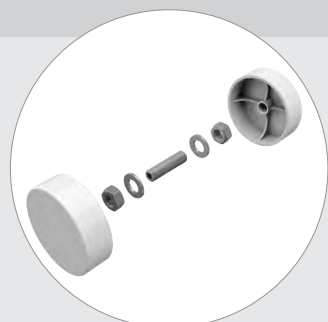

plastic, light grey
incl. threaded steel rod M12
for all hinged end plates and
hinged flange plates with 78 mm dia.
1 pair
0.211 kg

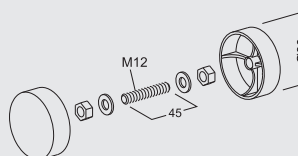

M 1278

M 1278.35

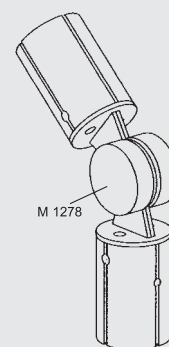

HINGED END PLATES

HINGED PLATE WITH EYELET

steel
incl. 1 anti-slipping device M 1299
for all hinges with 78 mm dia.
0.194 kg

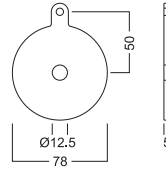

M 1279

M 1279.21

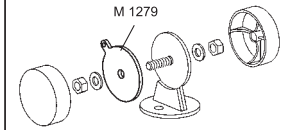

STEEL WIRE WITH TURNBUCKLE

stainless steel
tensile strength 4,5 kN (ca. 450 kg)
length on request

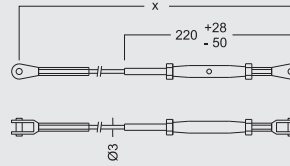

M 1280

M 1280.00

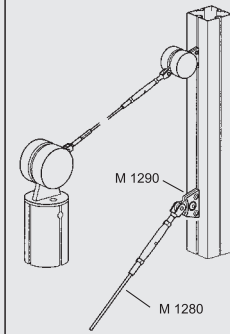

ANTI-SLIPPING DEVICE

flocked self-adhesive paper
for all hinged end plates and
hinged flange plates with 78 mm dia.

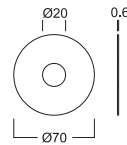

M 1299

M 1299.33

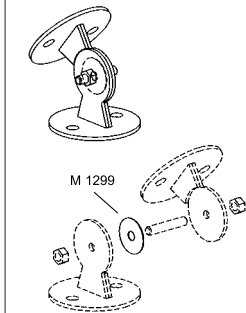

LOUVER EXTRUSIONS

LOUVER EXTRUSION



aluminium
1 system groove 4.3 mm
at each end with insert groove for 2 mm
thick panels
5000 mm long
5.59 kg

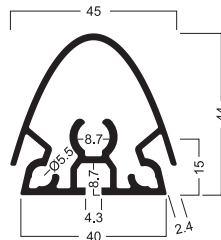

M 1502

M 1502.01

LOUVER EXTRUSION



aluminium
1 system groove 4.3 mm
at each end with insert groove for 2 mm
thick panels
6000 mm long
6.69 kg

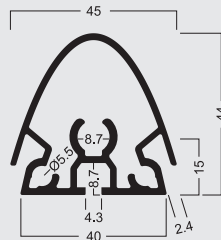

M 1503

M 1503.01

END PLATE

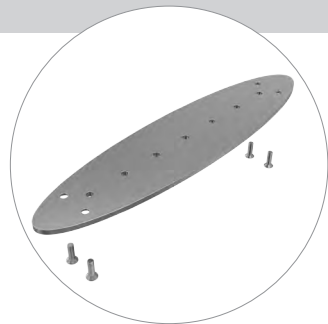

steel
incl. 4 countersunk screws M 1510/20 (M6)
0.881 kg

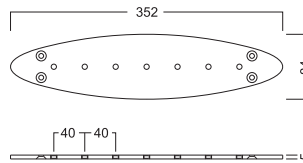

M 1510

M 1510.21

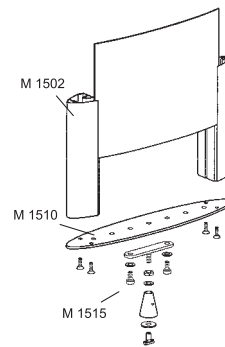

FIXING SET

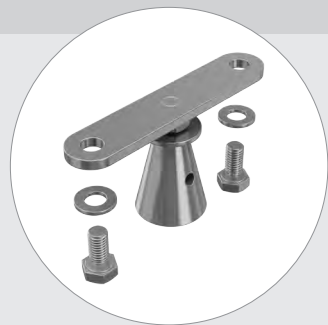

steel
incl. mounting parts M8
0.191 kg

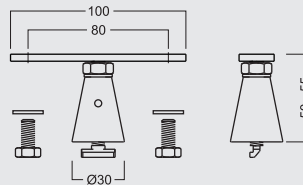

M 1515

M 1515.37

TRUSS BEAMS

CONNECTOR HEAD

aluminium
 incl. 2 end plates M 108, steel (powder coated black RAL 9005)
 8 groove-filler pieces M 102
 1 adaptor M 115 and
 1 screw-set M 103
 for all 120 mm extrusions
 6.977 kg

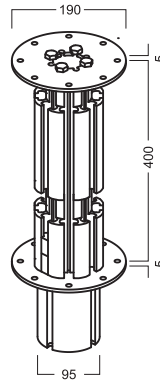

M 110

M 110.01

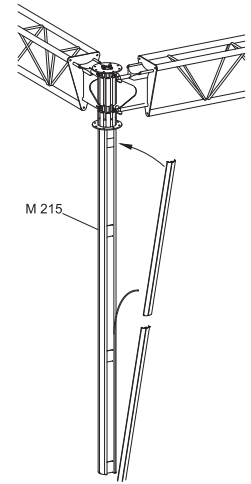

ADAPTOR SET

steel, zinc plated
 incl. 1 end plate M 108 (powder coated black RAL 9005)
 and 1 screw-set M 103 (M10)
 for all round extrusions 120 mm dia.
 1.817 kg

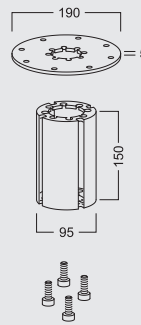
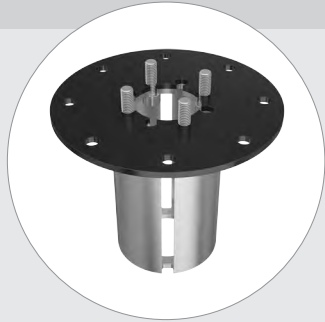

M 125

M 125.90

CONNECTOR HEAD

aluminium
 incl. 2 end plates M 108, steel (powder coated black RAL 9005)
 8 groove-filler pieces M 102
 1 adaptor M 115 and
 2 screw-sets M 103
 for upright M 300
 5.884 kg

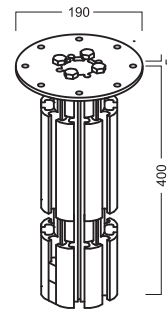

M 130

M 130.01

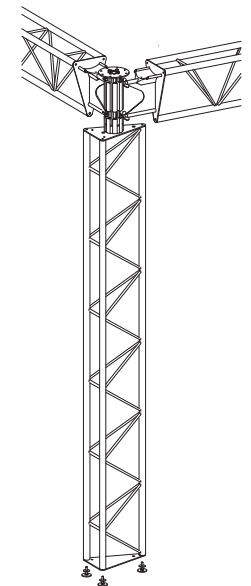

TRUSS BEAMS

UPRIGHT

aluminium
 incl. 1 end plate M 412 and
 1 endplate M 413 with adjustable feet-set
 M 380
 for connector head M 130
 total length 3020 mm
 16 kg

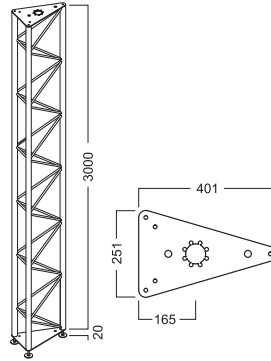

M 300

M 300.01

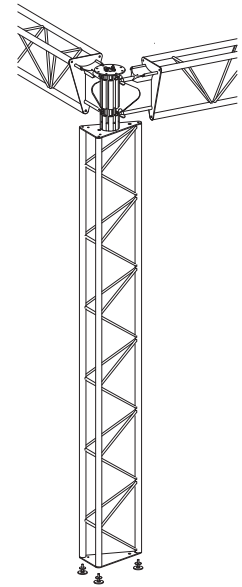

TRIANGULAR TRUSS BEAM

aluminium
 incl. 2 end plates M 412
 for mounting to M 500, M 510, M 530 and
 M 531
4 system axes - 3332 mm
 (incl. end plates)
 17.82 kg

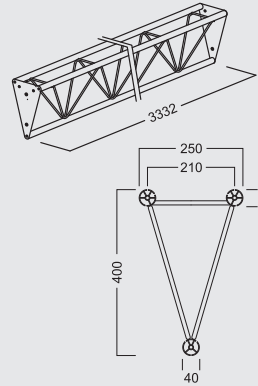
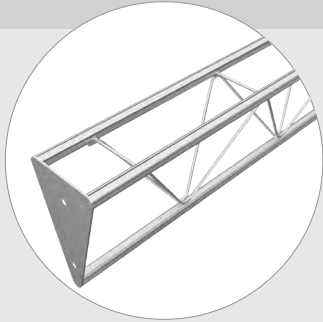

M 440

M 440.01

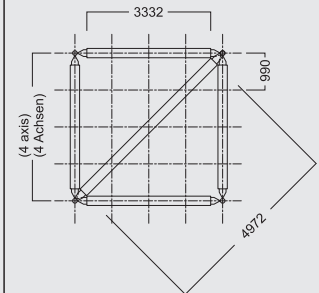

TRIANGULAR TRUSS BEAM

aluminium
 incl. 2 end plates M 412
 for mounting to M 500, M 510, M 530 and
 M 531
4 system axes - diagonal - 4972 mm
 (incl. end plates)
 25.75 kg

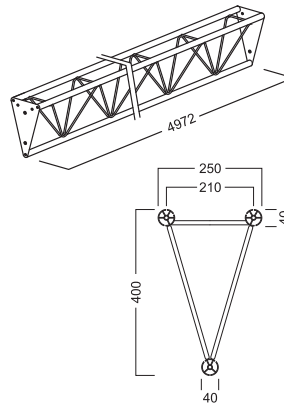
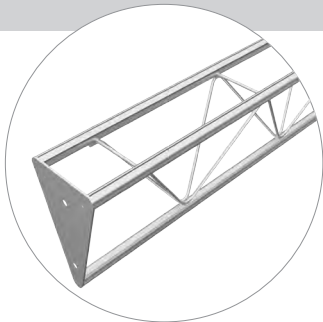

M 441

M 441.01

MAXIMA LIGHT

TRUSS BEAMS

TRIANGULAR TRUSS BEAM

aluminium
 incl. 2 end plates M 412
 for mounting to M 500, M 510, M 530 and
 M 531
5 system axes - 4322 mm
 (incl. end plates)
 22.57 kg

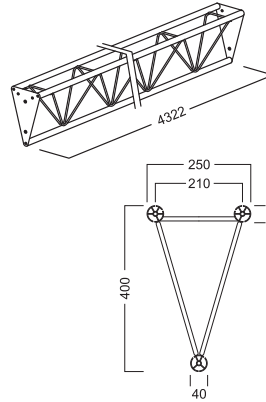
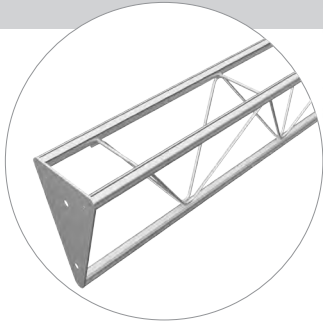

M 450

M 450.01

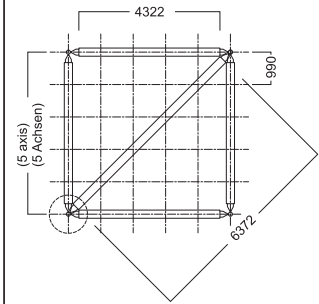

TRIANGULAR TRUSS BEAM

aluminium
 incl. 2 end plates M 412
 for mounting to M 500, M 510, M 530 and
 M 531
5 system axes - diagonal - 6372 mm
 (incl. end plates)
 30.1 kg

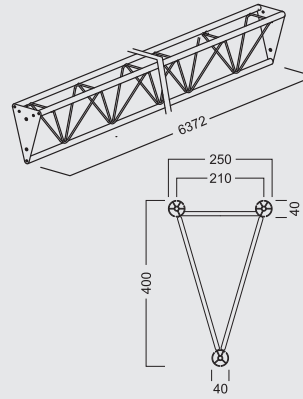
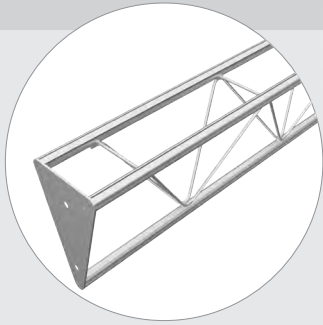

M 451

M 451.01

FLANGE FOR TRUSS BEAM

aluminium
 incl. wing nut quick connector and
 screw accessories M10 and M16
 for triangular truss beams M 440 - M 491
distance to center of connector head
314 mm
 2.189 kg

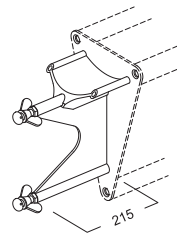

M 500

M 500.01

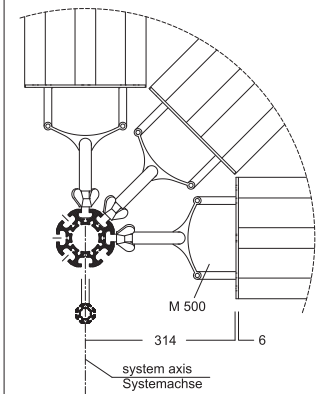

TRUSS BEAMS

FLANGE FOR TRUSS BEAM

aluminium
incl. wing nut quick connector and
fixing screws M10 and M16
for triangular truss beams M 440 - M 491
**distance to center of connector head
209 mm**
1.596 kg

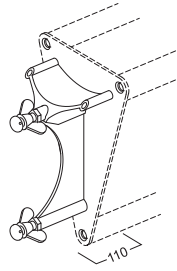

M 510

M 510.01

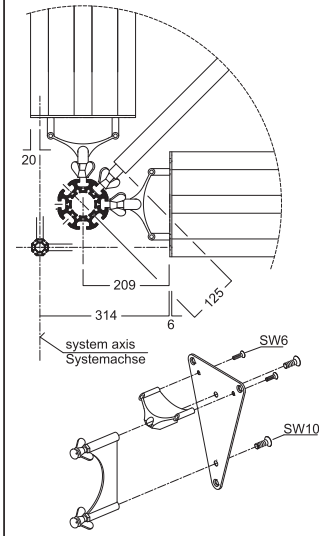

CORNER CONNECTOR
90° "HORIZONTAL"

aluminium
incl. fixing screws M 551
5.152 kg

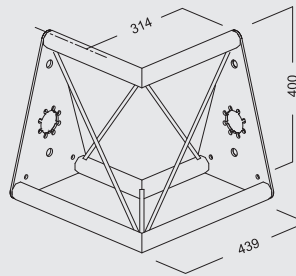
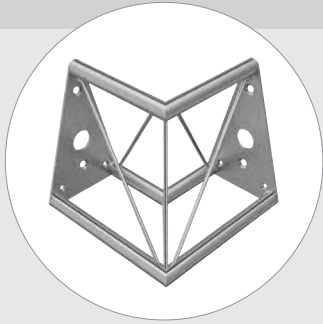

M 520

M 520.21

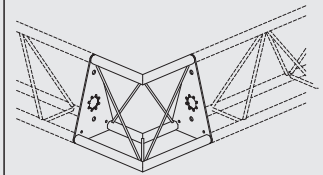

ADJUSTABLE
CONNECTION FLANGE

aluminium
incl. fixing screws
for fixing triangular truss beams
M 440 - M 491 to system groove
**distance to center of connector head
314 mm**
2.871 kg

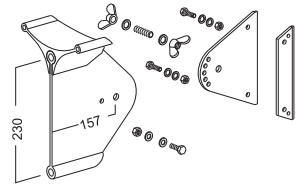
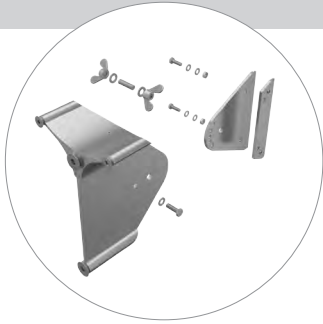

M 531

M 531.21

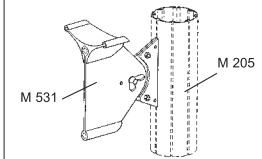

TRUSS BEAMS

STABILIZING DIAGONAL TUBE

aluminium
incl. 2 hammerhead screws M 812 (M10)
0.4 kg

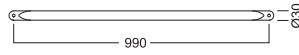

M 535

M 535.21

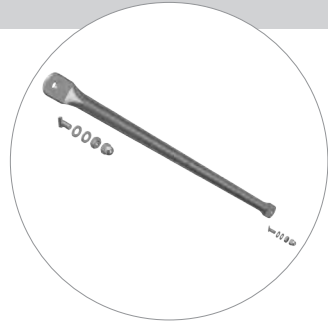
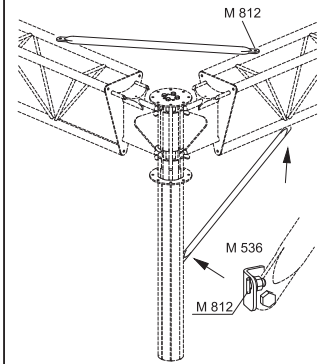

FIXING ANGLE

aluminium
incl. fixing screws M10
for mounting M 535 to upright extrusion
0.145 kg

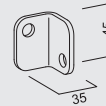

M 536

M 536.00

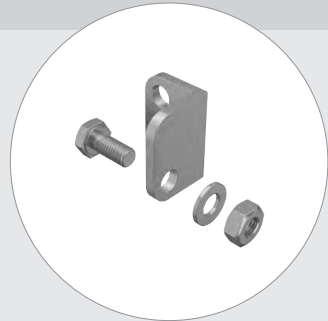

SCREW SET

steel
M10 / M16
for extension of triangular truss beams
1.001 kg

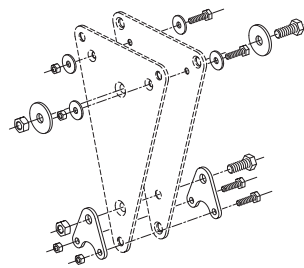

M 550

M 550.37



SUSPENSION CONNECTOR

steel
incl. mounting parts
for mounting triangular truss and flat
beams on **both sides**
2.111 kg

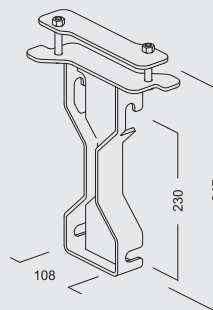

M 555

M 555.37

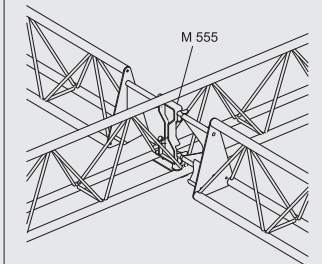

TRUSS BEAMS

SUSPENSION CONNECTOR

M 556

steel
incl. mounting parts
for mounting triangular truss and flat
beams on **one side**
2.731 kg

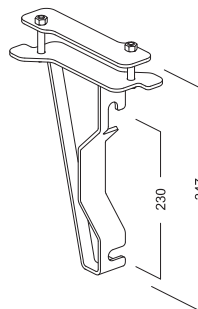

M 556.37

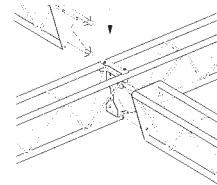

FLAT TRUSS BEAMS

FLAT TRUSS BEAM

aluminium
with wing nut quick connector M 611
4 system axes - 3710 mm
9.38 kg

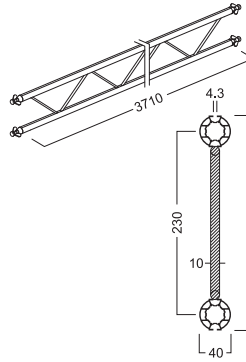
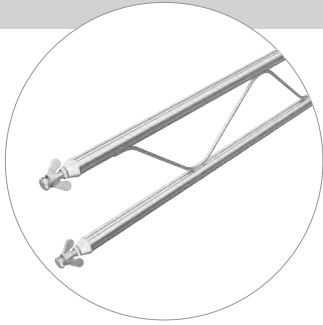

M 640

M 640.01

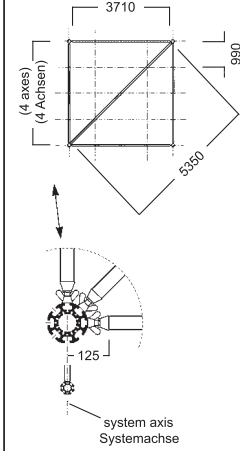

FLAT TRUSS BEAM

aluminium
with wing nut quick connector M 611
4 system axes - diagonal - 5350 mm
13.054 kg

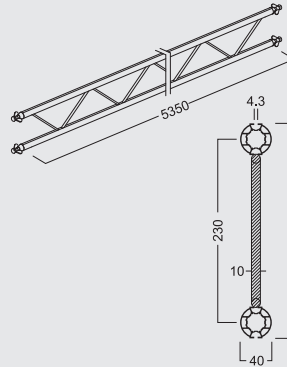
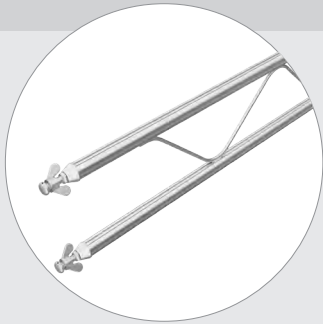

M 641

M 641.01

FLAT TRUSS BEAM

aluminium
with wing nut quick connector M 611
5 system axes - 4700 mm
12.017 kg

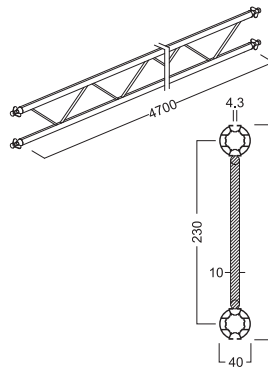

M 650

M 650.01

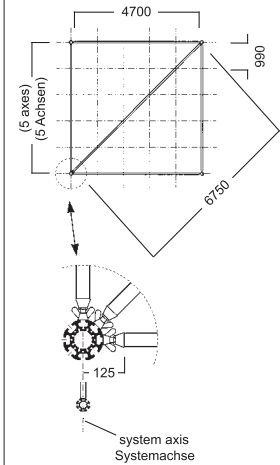

FLAT TRUSS BEAMS

FLAT TRUSS BEAM

aluminium
with wing nut quick connector M 611
5 system axes - diagonal - 6750 mm
17.23 kg

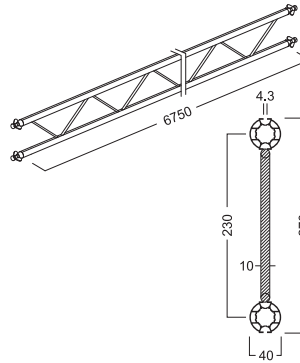

M 651

M 651.01

SUSPENSION CONNECTOR

steel
incl. mounting parts for
mounting flat truss beams on 1 side or on
both sides
1.13 kg

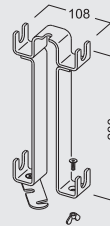
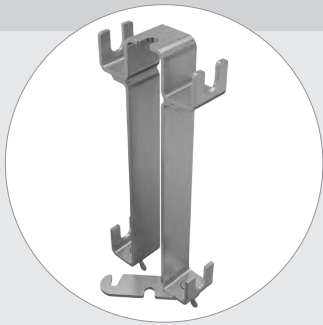

M 655

M 655.37

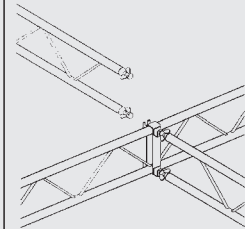

CONNECTION FLANGE

aluminium
incl. fixing screws
for flat truss beams M 640 - M 651
to be mounted to system groove
distance to center of connector head
314 mm
2.813 kg

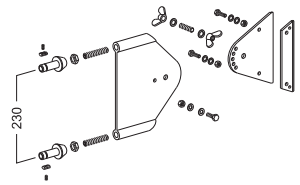

M 661

M 661.01

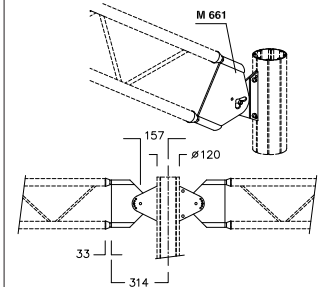

FLAT TRUSS BEAMS

BEAM EXTRUSION

aluminium
 2 tension locks Z 961/8 can be mounted in
 2 positions
 or 3 tension locks Z 961/13 with Z 161/A
7000 mm long
 35.533 kg

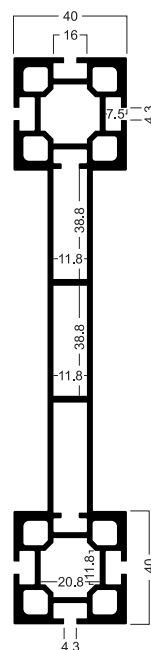
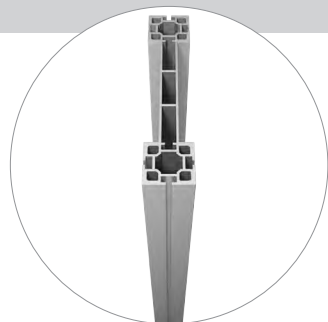

M 770

M 770.00

FLAT TRUSS BEAM

aluminium
 incl. 4 tension locks Z 961/8
3 system axes - 2930 mm
 7.491 kg

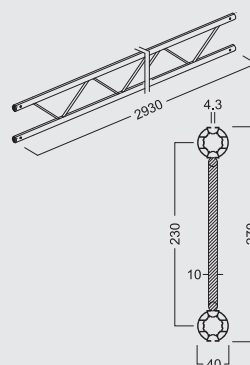
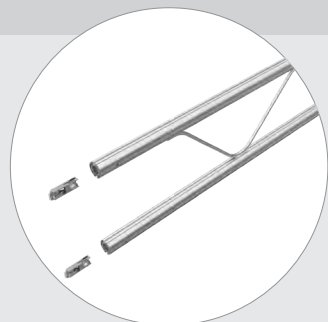

M 703

M 703.01

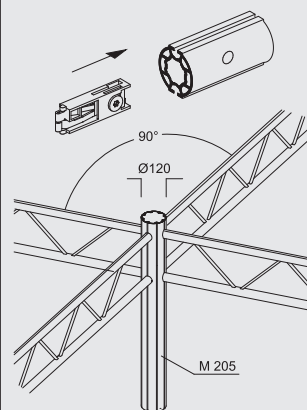

FLAT TRUSS BEAM

aluminium
 incl. 4 tension locks Z 961/8
4 system axes - 3920 mm
 9.496 kg

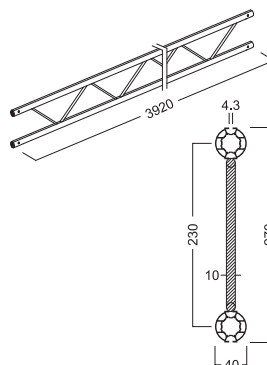
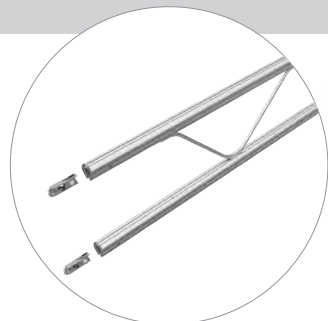

M 704

M 704.01

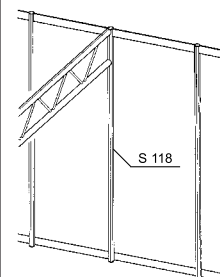

FLAT TRUSS BEAMS

FLAT TRUSS BEAM

aluminium
incl. 4 tension locks Z 961/8
5 system axes - 4910 mm
13.181 kg

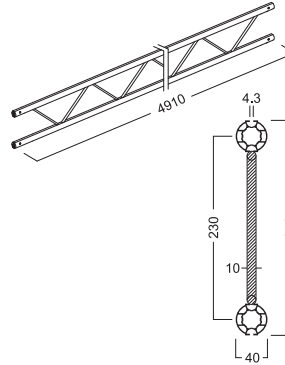
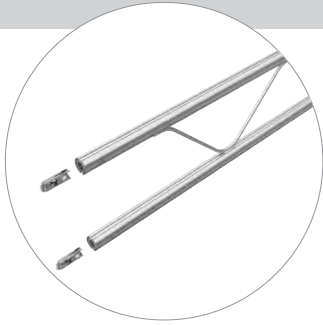

M 705

M 705.01

FLAT TRUSS BEAM

aluminium
incl. 4 tension locks Z 961/8
6 system axes - 5900 mm
15.701 kg

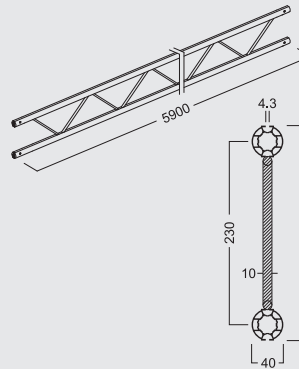
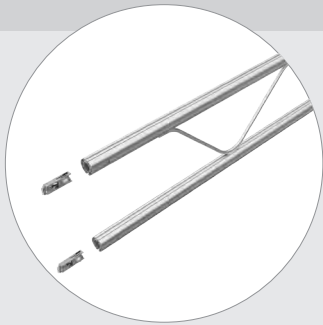

M 706

M 706.01

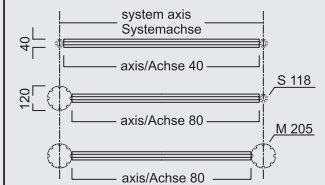

FLAT TRUSS BEAM ADAPTOR

steel
incl. fixing screws
for flat truss beams without
tension lock Z 961/8
0.278 kg

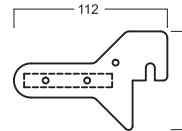

M 755

M 755.37

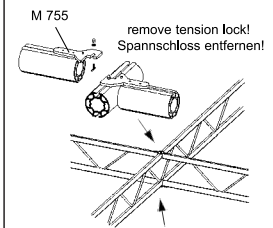

HINGED CLAMP

steel
with rubber sheathing, black and clamping
screw M5
for suspension on Maxima beams
admissible load 80 kg
0.091 kg

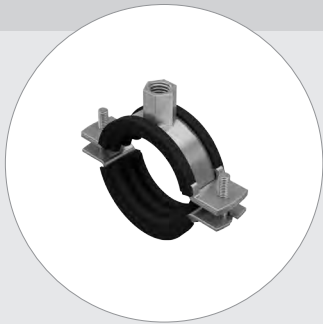

M 827

M 827.37

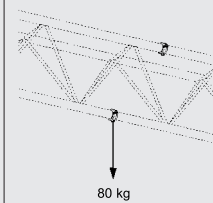

MAXIMA LIGHT

TIE ROD TENSIONING SETS

TIE ROD TENSIONING SET / 7 AXES

aluminium/steel
incl. compression struts, tension braces, tension brace junction nodes, angle reinforcements, connector parts and screw accessories
square extrusion M 227 to be ordered separately
Attention: Please observe the prescribed construction due to security reasons and refer to the "Technical Information" sheets
6810 mm long
12.785 kg

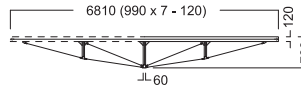
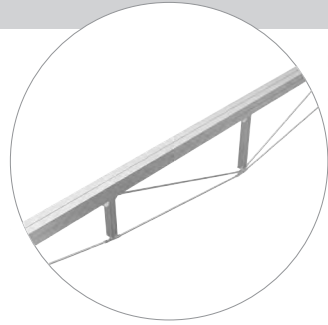

M 727

M 727.90

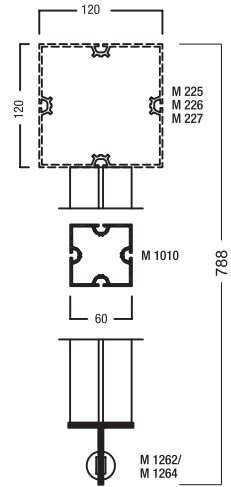

TIE ROD TENSIONING SET / 8 AXES

aluminium/steel
incl. compression struts, tension braces, tension brace junction nodes, angle reinforcements, connector parts and screw accessories
square extrusion M 225 and extension adaptor M 1133 to be ordered separately
Attention: Please observe the prescribed construction due to security reasons and refer to the "Technical Information" sheets
7800 mm long
13.955 kg

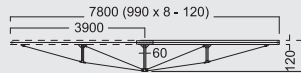
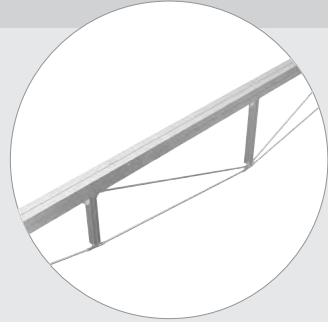

M 728

M 728.90

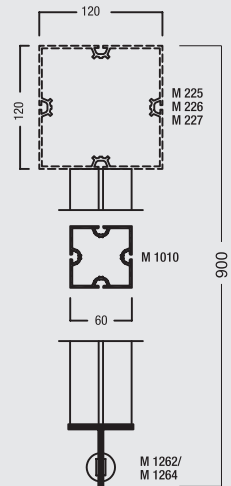

TIE ROD
TENSIONING SETS

TIE ROD TENSIONING
SET / 10 AXES

aluminium/steel
incl. compression struts, tension braces,
tension brace junction nodes, angle
reinforcements, connector parts and screw
accessories
**square extrusion M 225 and extension
adaptor M 1133 to be ordered
separately**
**Attention: Please observe the prescribed
construction due to security reasons
and refer to the "Technical Information"
sheets**
9780 mm long
16.219 kg

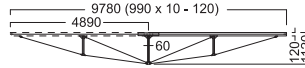

M 730

M 730.90

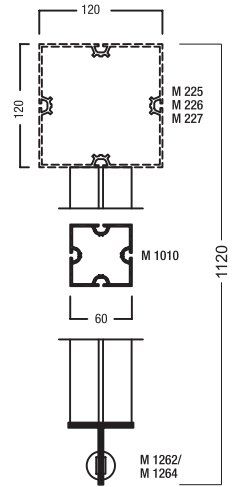

TIE ROD TENSIONING
SET / 12 AXES

aluminium/steel
incl. compression struts,
tension braces, tension brace junction
nodes, angle reinforcements, connector
parts and screw accessories
**square extrusion M 226 and extension
adaptor M 1133 to be ordered
separately**
**Attention: Please observe the prescribed
construction due to security reasons
and refer to the "Technical Information"
sheets**
11760 mm long
17.841 kg

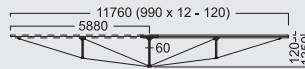

M 732

M 732.90

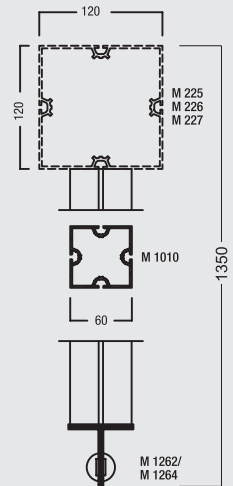

TIE ROD
TENSIONING SETS

TIE ROD TENSIONING
SET / 14 AXES

aluminium / steel
incl. compression struts, tension braces,
tension brace junction nodes, angle
reinforcements, connector parts and screw
accessories

**square extrusion M 227 and extension
adaptor M 1133 to be ordered
separately**

**Attention: Please observe the prescribed
construction due to security reasons
and refer to the "Technical Information"
sheets**

13740 mm long

20.865 kg

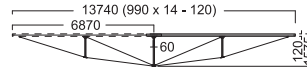
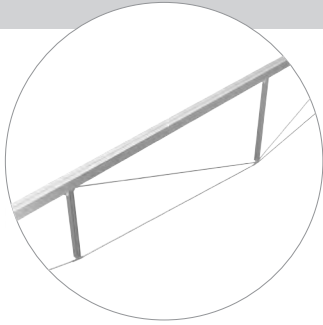

M 734

M 734.90

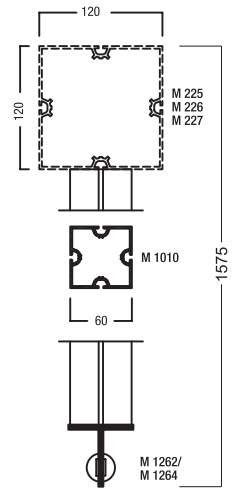

TRUSS GIRDERS

TRUSS GIRDER / 7 AXES

aluminium/steel
 includes compression struts, tension rods,
 tension rod connectors, reinforcements and
 bolts
**Attention: Maxima square extrusions
 are included !**
**For safety reasons the use of adaptors
 with safety tension locks M 1124/
 M 1126 is recommended !**
6810 mm long
69 kg

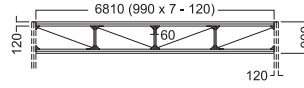
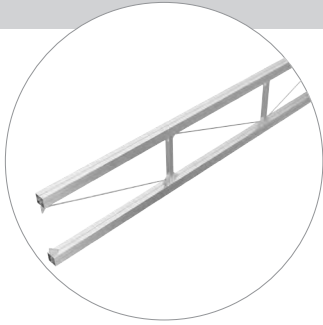

M 737

TRUSS GIRDERS

M 737.90

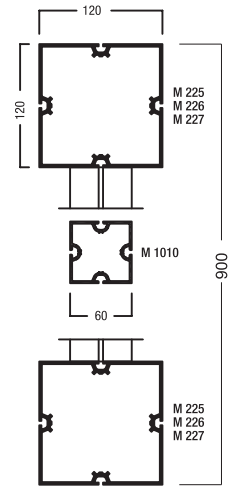

TRUSS GIRDER / 8 AXES

aluminium/steel
 includes compression struts, tension rods,
 tension rod connectors, reinforcements and
 bolts
**Attention: Maxima square extrusions
 are included !**
**For safety reasons the use of adaptors
 with safety tension locks M 1124/
 M 1126 is recommended !**
7800 mm long
82 kg

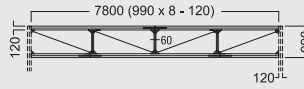
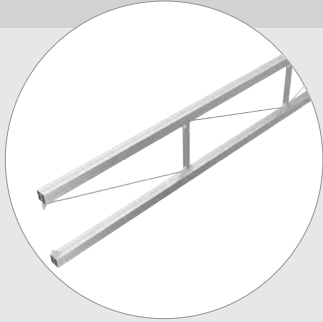

M 738

M 738.90

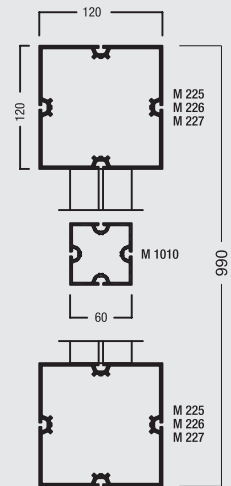

TRUSS GIRDERS

TRUSS GIRDER / 10 AXES

aluminium/steel
 includes compression struts, tension rods,
 tension rod connectors, reinforcements and
 bolts
**Attention: Maxima square extrusions
 are included !**
**For safety reasons the use of adaptors
 with safety tension locks M 1124/
 M 1126 is recommended !**
9780 mm long
99 kg

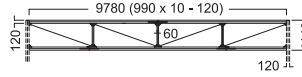

M 740

TRUSS GIRDERS

M 740.90

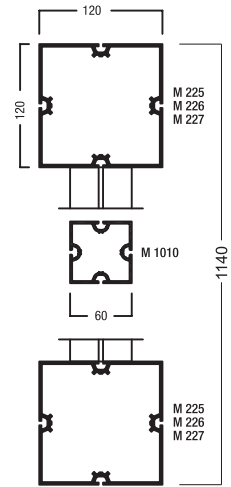

TRUSS GIRDER / 12 AXES

aluminium/steel
 includes compression struts, tension rods,
 tension rod connectors, reinforcements and
 bolts
**Attention: Maxima square extrusions
 are included !**
**For safety reasons the use of adaptors
 with safety tension locks M 1124/
 M 1126 is recommended !**
11760 mm long
117 kg

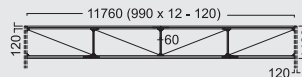
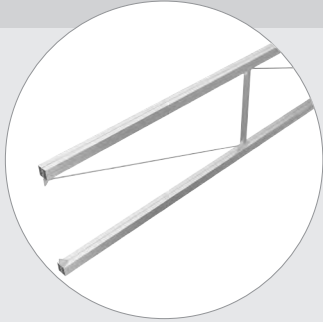

M 742

M 742.90

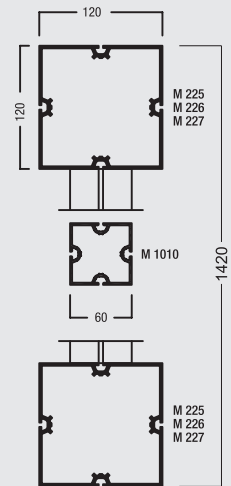

TRUSS GIRDERS

TRUSS GIRDER / 14 AXES

aluminium/steel
 includes compression struts, tension rods,
 tension rod connectors, reinforcements and
 bolts
**Attention: Maxima square extrusions
 are included !**
**For safety reasons the use of adaptors
 with safety tension locks M 1124/
 M 1126 is recommended !**
13740 mm long
134 kg

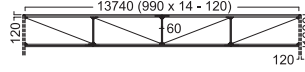

M 744

M 744.90

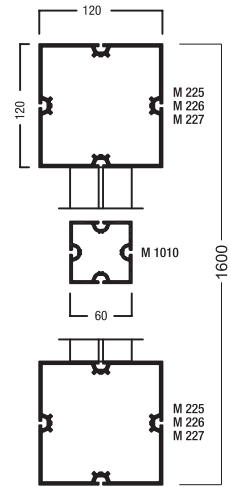

TRUSS GIRDER / 6 AXES

aluminium/steel
 includes compression struts, tension rods,
 tension rod connectors, reinforcements and
 bolts
**Attention: Maxima square extrusions
 are included !**
**For safety reasons the use of adaptors
 with safety tension locks M 1114/
 M 1116 is recommended !**
5860 mm long
41 kg

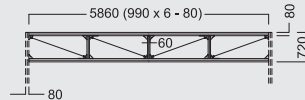
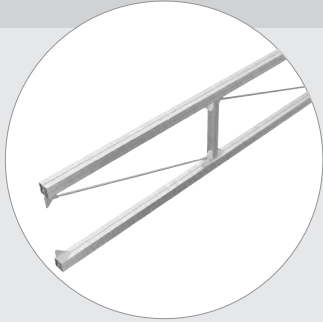

M 746

M 746.90

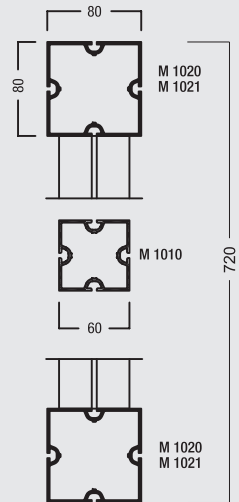

TRUSS GIRDERS

TRUSS GIRDER / 7 AXES

aluminium/steel
 includes compression struts, tension rods,
 tension rod connectors, reinforcements and
 bolts
**Attention: Maxima square extrusions
 are included !**
**For safety reasons the use of adaptors
 with safety tension locks M 1114/
 M 1116 is recommended !**
6850 mm long
48 kg

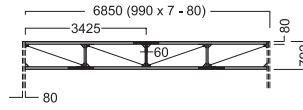
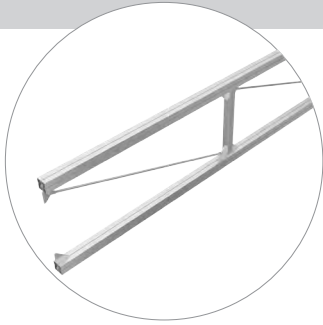

M 747

TRUSS GIRDERS

M 747.90

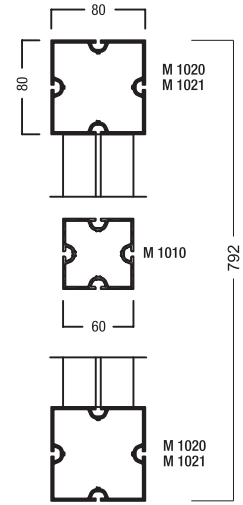

TRUSS GIRDER / 8 AXES

aluminium/steel
 includes compression struts, tension rods,
 tension rod connectors, reinforcements and
 bolts
**Attention: Maxima square extrusions
 are included !**
**For safety reasons the use of adaptors
 with safety tension locks M 1114/
 M 1116 is recommended !**
7840 mm long
53 kg

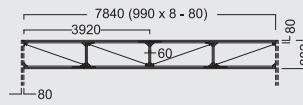

M 748

M 748.90

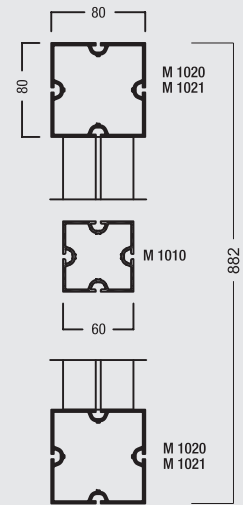

TRUSS GIRDERS

TRUSS GIRDER / 10 AXES

aluminium/steel
 includes compression struts, tension rods,
 tension rod connectors, reinforcements and
 bolts
**Attention: Maxima square extrusions
 are included !**
**For safety reasons the use of adaptors
 with safety tension locks M 1114/
 M 1116 is recommended !**
9820 mm long
64 kg

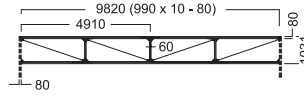
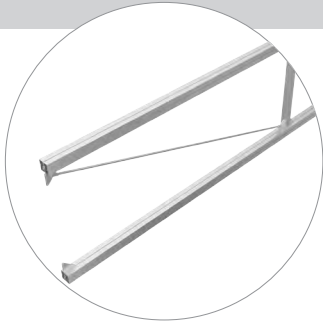

M 750

M 750.90

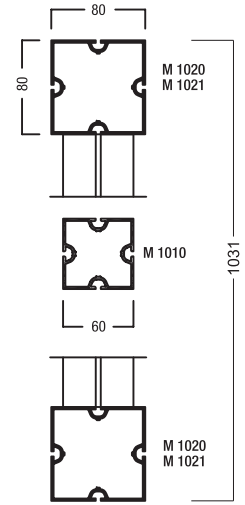

TRUSS GIRDER / 6 AXES

aluminium/steel
 includes compression struts, tension rods,
 tension rod connectors, reinforcements and
 bolts
**Attention: Maxima square extrusions
 are included !**
**For safety reasons the use of adaptors
 with safety tension locks M 1114/
 M 1116 for the extrusion above is
 recommended !**
5860 mm long
44 kg

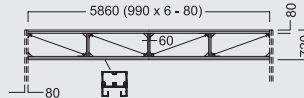
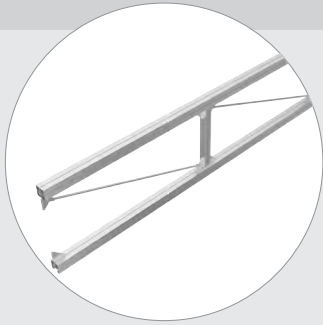

M 756

M 756.90

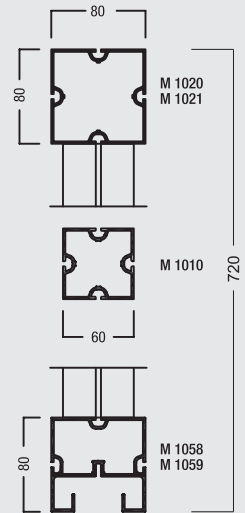

TRUSS GIRDERS

TRUSS GIRDER / 7 AXES

aluminium/steel
 includes compression struts, tension rods,
 tension rod connectors, reinforcements and
 bolts
**Attention: Maxima square extrusions
 are included !**
**For safety reasons the use of adaptors
 with safety tension locks M 1114/
 M 1116 for the extrusion above is
 recommended !**
6850 mm long
51.091 kg

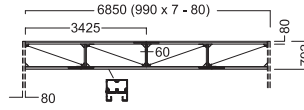
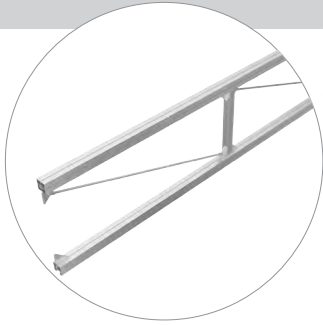

M 757

TRUSS GIRDERS

M 757.90

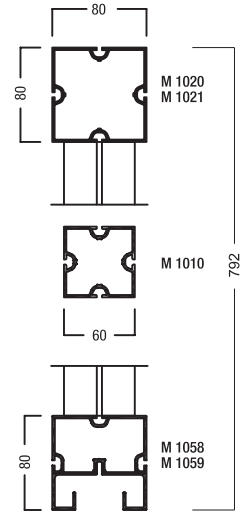

TRUSS GIRDER / 8 AXES

aluminium/steel
 includes compression struts, tension rods,
 tension rod connectors, reinforcements and
 bolts
**Attention: Maxima square extrusions
 are included !**
**For safety reasons the use of adaptors
 with safety tension locks M 1114/
 M 1116 for the above extrusion is
 recommended !**
7840 mm long
57 kg

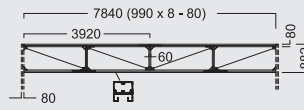

M 758

M 758.90

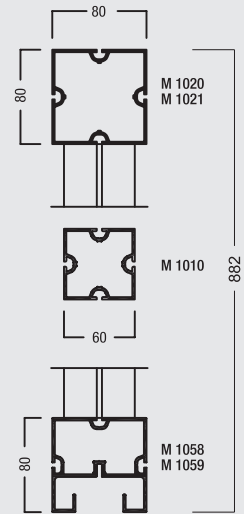

TRUSS GIRDERS

TRUSS GIRDER / 10 AXES

aluminium/steel
 includes compression struts, tension rods,
 tension rod connectors, reinforcements and
 bolts
**Attention: Maxima square extrusions
 are included !**
**For safety reasons the use of adaptors
 with safety tension locks M 1114/
 M 1116 for the extrusion above is
 recommended !**
9820 mm long
68 kg

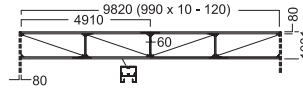
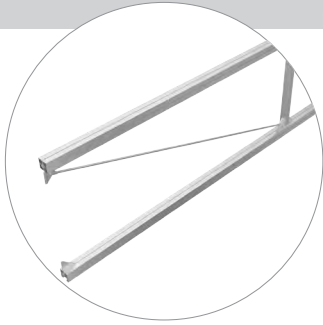

M 760

M 760.90

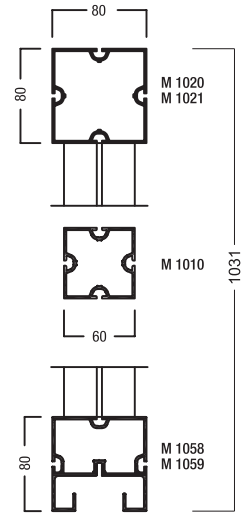

TRUSS GIRDER / 6 AXES

aluminium/steel
 includes compression struts, tension rods,
 tension rod connectors, reinforcements and
 bolts
**Attention: Maxima square extrusions
 are included !**
**For safety reasons the use of adaptors
 with safety tension locks M 1114/
 M 1116 for the extrusion above is
 recommended !**
5860 mm long
34 kg

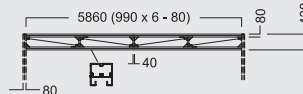

M 776

M 776.90

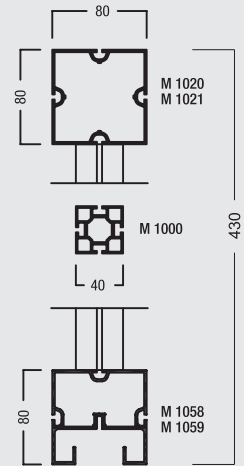

TRUSS GIRDERS

TRUSS GIRDER / 7 AXES

aluminium/steel
 includes compression struts, tension rods,
 tension rod connectors, reinforcements and
 bolts
**Attention: Maxima square extrusions
 are included !**
**For safety reasons the use of adaptors
 with safety tension locks M 1114/
 M 1116 for the extrusion above is
 recommended !**
6850 mm long
45 kg

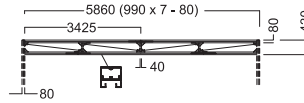

M 777

TRUSS GIRDERS

M 777.90

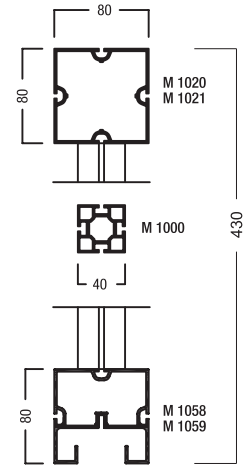

TRUSS GIRDER / 8 AXES

aluminium/steel
 includes compression struts, tension rods,
 tension rod connectors, reinforcements and
 bolts
**Attention: Maxima square extrusions
 are included !**
**For safety reasons the use of adaptors
 with safety tension locks M 1114/
 M 1116 for the extrusion above is
 recommended !**
7840 mm long
54 kg

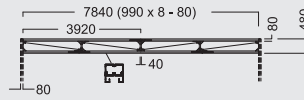

M 778

M 778.90

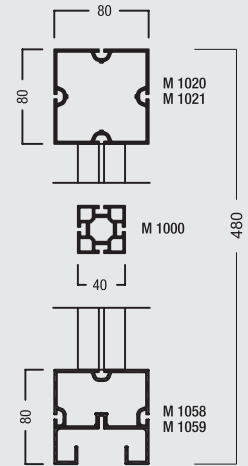

TRUSS GIRDER / 10 AXES

aluminium/steel
 includes compression struts, tension rods,
 tension rod connectors, reinforcements and
 bolts
**Attention: Maxima square extrusions
 are included !**
**For safety reasons the use of adaptors
 with safety tension locks M 1114/
 M 1116 for the extrusion above is
 recommended !**
9820 mm long
58 kg

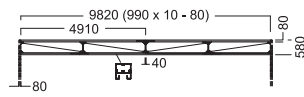

M 780

M 780.90

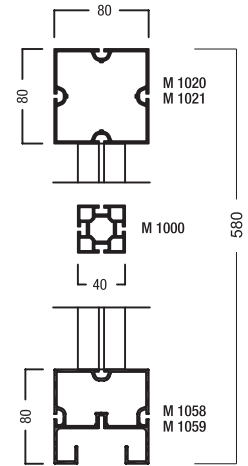

TRUSS GIRDERS

TRUSS GIRDER / 5 AXES

aluminium/steel
includes compression struts, tension rods,
tension rod connectors, reinforcements and
bolts
**Attention: Maxima square extrusions
are included !**
4870 mm long
27 kg

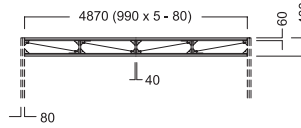

M 785

M 785.90

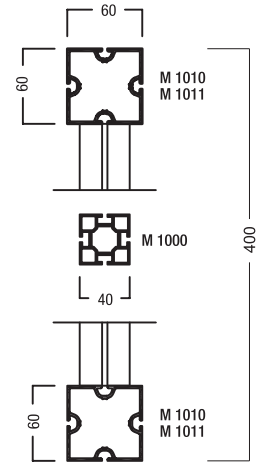

TRUSS GIRDER / 6 AXES

aluminium/steel
includes compression struts, tension rods,
tension rod connectors, reinforcements and
bolts
**Attention: Maxima square extrusions
are included !**
5860 mm long
30.349 kg

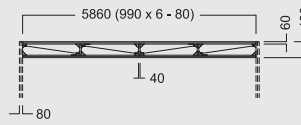

M 786

M 786.90

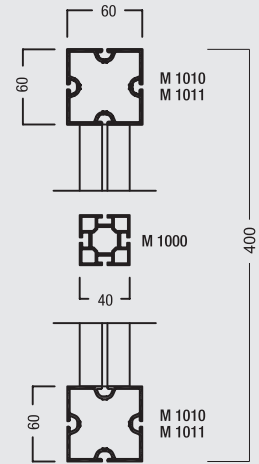

TRUSS GIRDER / 7 AXES

aluminium/steel
includes compression struts, tension rods,
tension rod connectors, reinforcements and
bolts
**Attention: Maxima square extrusions
are included !**
6850 mm long
33.658 kg

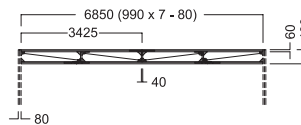

M 787

M 787.90

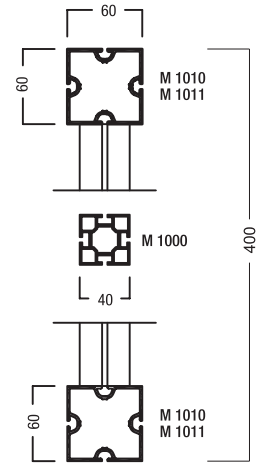

MAXIMA LIGHT

TRUSS GIRDERS

ANGLE REINFORCEMENT

steel
incl. 2 set screws M 1435/70 (M8) and
2 round head screws with flange
M 1557/20 (M6)
for system groove 4,3 mm
0.205 kg

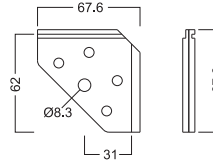

M 1150

ACCESSORIES

M 1150.37

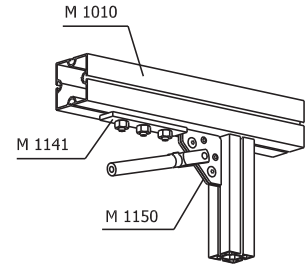

ANGLE REINFORCEMENT

steel
incl. 3 set screws M 1435/70 (M8) and
2 round head screws with flange
M 1557/20 (M6)
for system groove 4.3 mm
0.376 kg

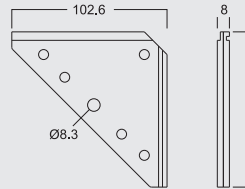

M 1129

M 1129.37

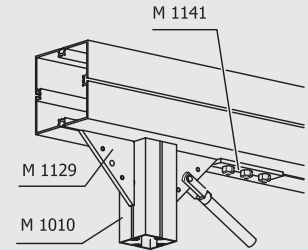

CONNECTOR PART

steel
incl. 3 set screws M 1435/70 (M8) and
2 round head screws with flange
M 1557/20 (M6)
for mounting to system groove 4.3 mm,
to be used for rope suspensions
0.531 kg

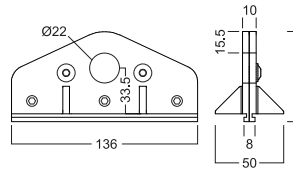

M 1172

M 1172.37

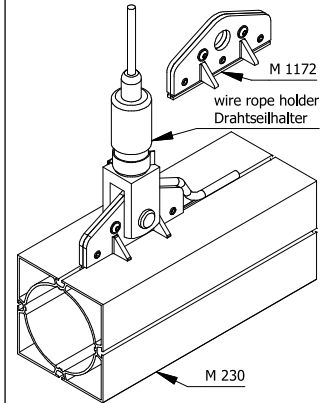

CONNECTOR PART

steel
incl. 3 set screws M 1435/70 (M8) and
2 round head screws with flange
M 1557/20 (M6)
for system groove 4.3 mm
0.338 kg

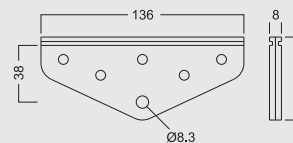

M 1132

M 1132.37

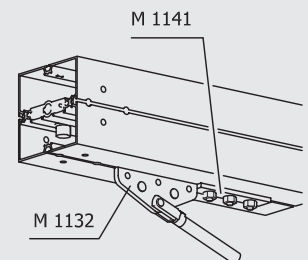

TRUSS GIRDERS

ANTI-SLIPPING DEVICE

steel
incl. 3 hammerhead screws M 1473
for system groove 4.3 mm
Attention: to be used for safety reasons
0.178 kg

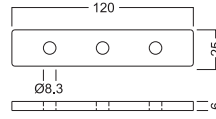
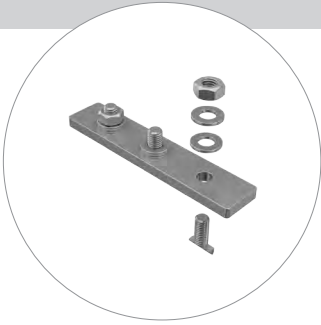

M 1141

M 1141.37

TENSION BRACE
JUNCTION KNOT

steel
incl. 2 countersunk screws M 1250/20 (M8)
for square extrusion M 1010
0.702 kg

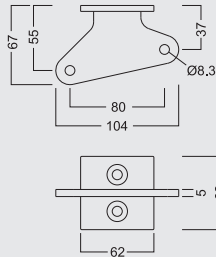
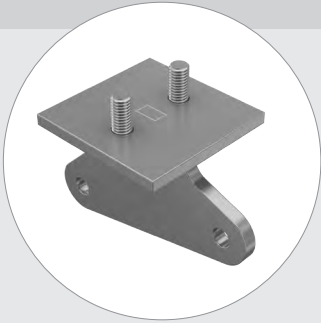

M 1262

M 1262.21

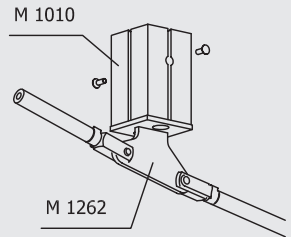

TENSION BRACE
JUNCTION KNOT

steel
incl. 2 countersunk screws M 1250/20 (M8)
for square extrusion M 1010
0.477 kg

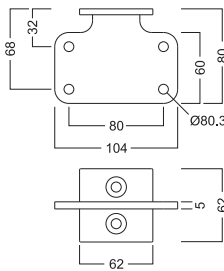

M 1264

M 1264.21

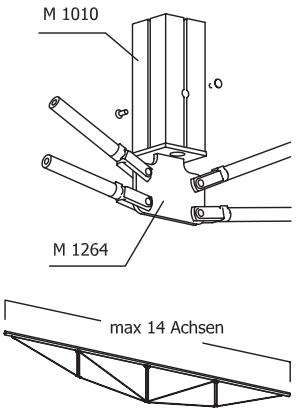

QUICKLINK

steel
incl. 1 set screw M 1137/20 (M8)
1 hexagon nut M 1137/30 (M8)
and spring hinged bolt
for mounting to round tube M 1460
0.102 kg

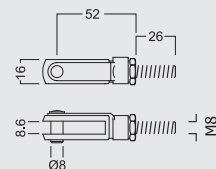

M 1137

M 1137.37

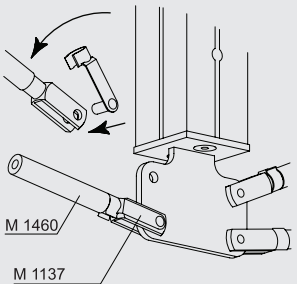

TRUSS GIRDERS

ANGLE REINFORCEMENT

steel
 incl. 4 set screws M 1435/70 (M8) and
 4 round head screws with flange
 M 1557/20 (M6)
 for system groove 4.3 mm
 1.981 kg

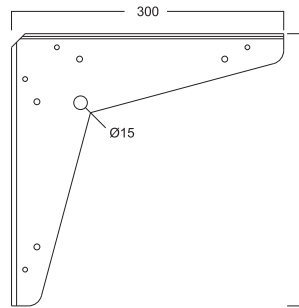

M 1139

ACCESSORIES

M 1139.37

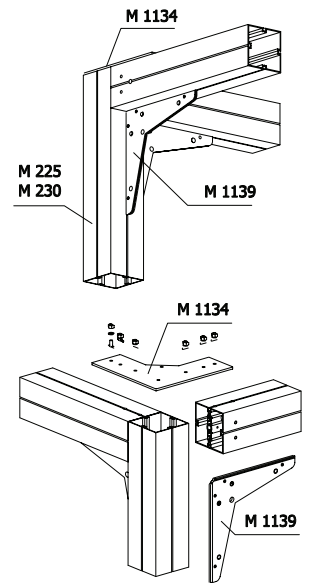

TRUSS GIRDERS

REINFORCING PLATE

steel
incl. 6 hammerhead screws M 1473 (M8)
for square extrusions 80 mm
Attention: item has to be used for safety reasons as "beam retainer"
1.38 kg

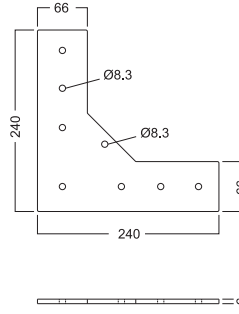
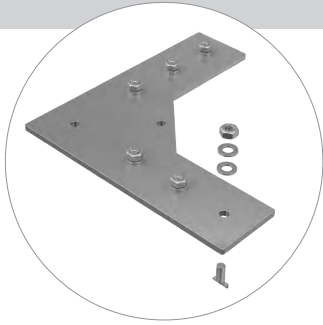

M 1164

M 1164.21

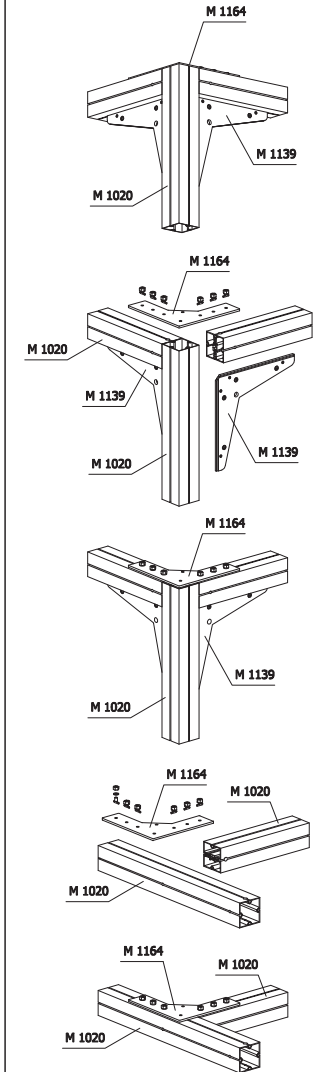

REINFORCING PLATE

steel
incl. 6 hammerhead screws M 1473 M8
for square extrusions 120 mm
Attention: to be used for safety reasons as "beam retainer"
2.436 kg

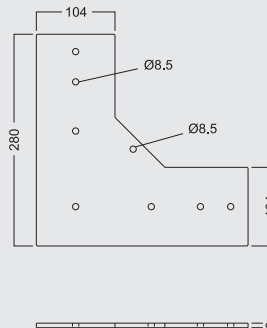
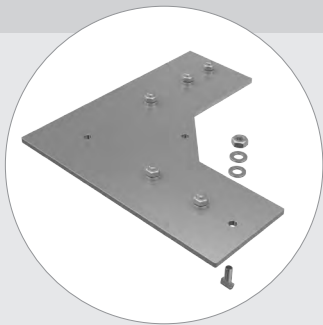

M 1134

M 1134.21

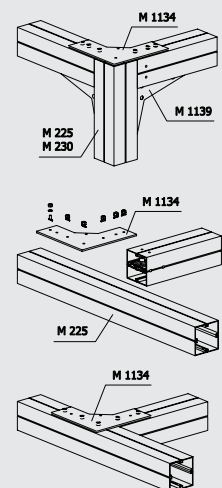

LIGHT WALL

LIGHT WALL EXTRUSION

aluminium
tension lock Z 961/13 can be mounted
6000 mm long
10.26 kg

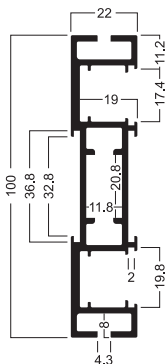
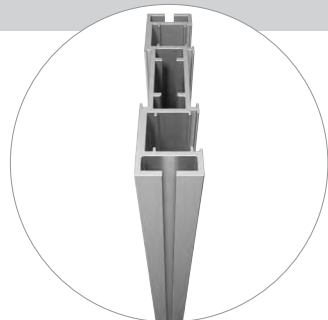

M 1800

M 1800.01

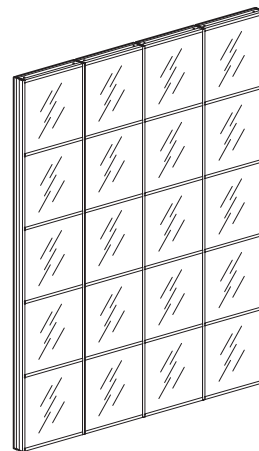

LIGHT WALL UPRIGHT EXTRUSION

aluminium
with 13 slots 27 x 4.3 mm
for connecting beams M 1825
5962 mm long
10.094 kg

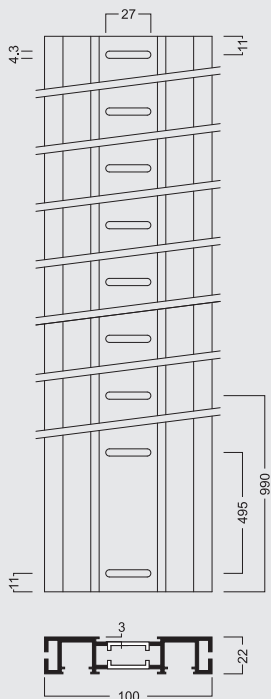

M 1810

M 1810.01

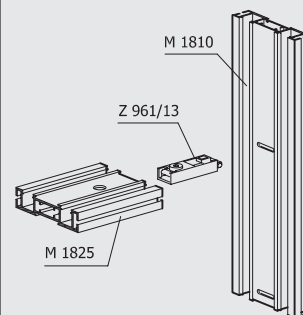

LIGHT WALL

LIGHT WALL BEAM

aluminium
incl. 2 built-in-tension locks Z 961/13
968 mm long
1.848 kg

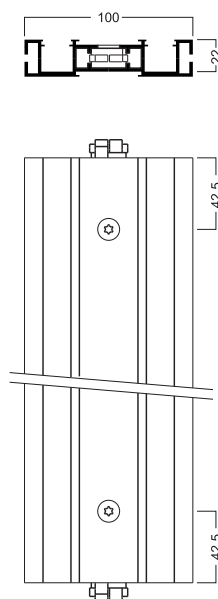

M 1825

M 1825.01

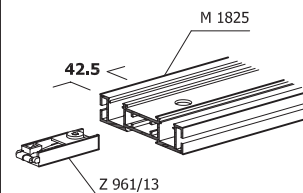

END PLATE

steel
incl. 2 set screws M 1075/20 (M4)
for light wall extrusion M 1810
0.056 kg

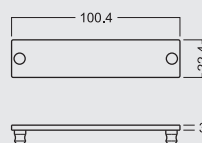
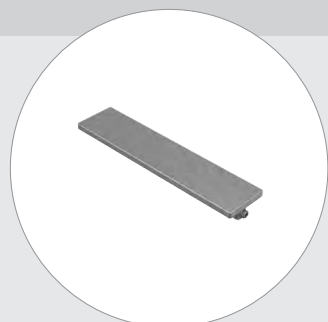

M 1835

M 1835.21

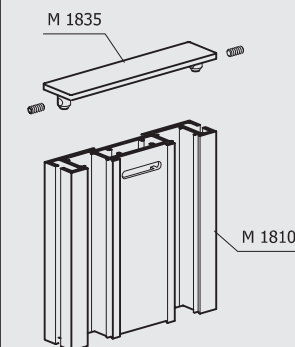

ADJUSTABLE FOOT

steel
thread M8
incl. 2 set screws M 1075/20 (M4)
for light wall extrusion M 1810
0.225 kg

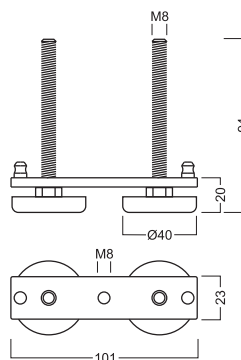

M 1836

M 1836.37

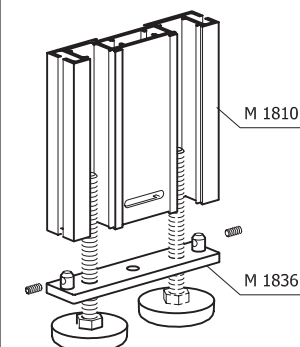

MAXIMA LIGHT

LIGHT WALL

**ADJUSTABLE FOOT
- BASE PLATE**

plastic
for adjustable foot M 1836
Attention:
increases total height by 2 mm
0.032 kg

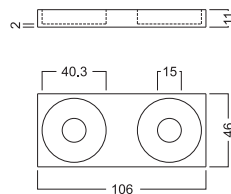

M 1837

M 1837.33



BASE PLATE

steel
incl. supporting peg M 1839/1
for light wall extrusions M 1800, M 1810
10.056 kg

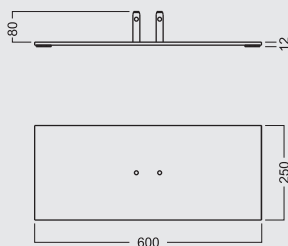
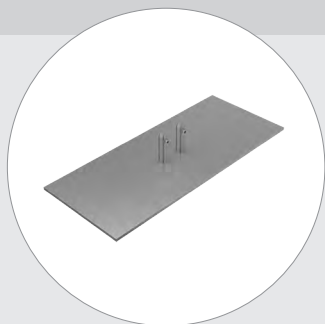

M 1839

M 1839.21

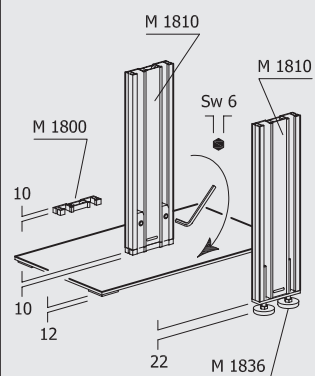

COVER EXTRUSION

plastic, semi-hard
for 4 mm panels
6000 mm long
0.42 kg

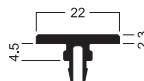
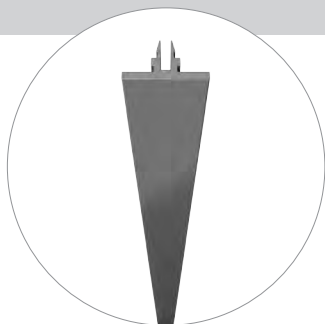

M 1844

M 1844.35

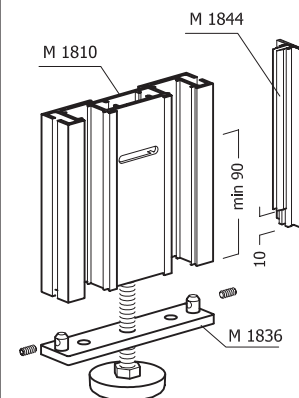

LIGHT WALL

COVER EXTRUSION

plastic, semi-hard
for 6 mm panels
6000 mm long
0.51 kg

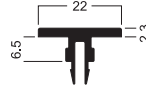
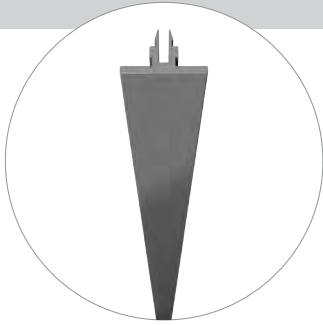

M 1846

M 1846.35

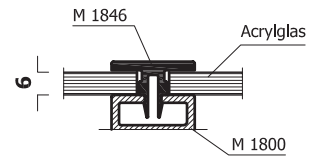
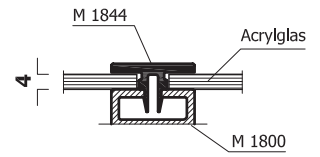

CABLE RETAINING CLIP

plastic
for fixation of cables in light wall extrusion
M 1800

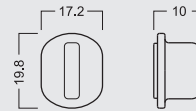

M 1850

M 1850.35

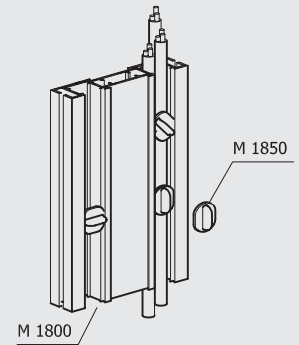

INTERNAL CORNER CONNECTOR

steel
incl. 4 set screws M 1852/20 (M5)
0.031 kg

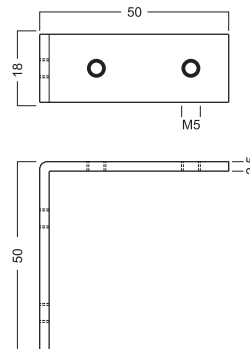

M 1852

M 1852.37

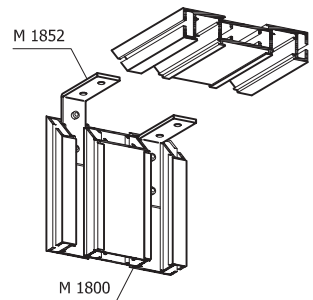

CONNECTING EXTRUSION

aluminium
for connecting to light wall extrusion
M 1800
5000 mm long
2.591 kg

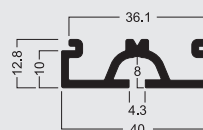
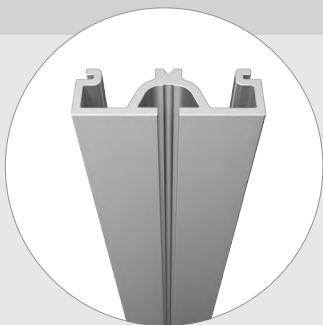

M 1870

M 1870.01

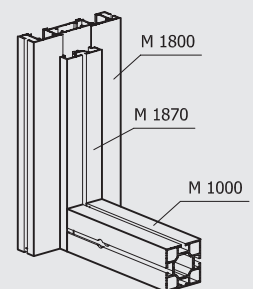

LIGHT WALL

CONNECTOR EXTRUSION

plastic
for connecting light wall extrusion M 1800
and upright extrusion with system groove
5000 mm long
0.89 kg

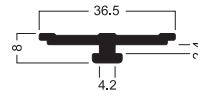

M 1875

M 1875.35

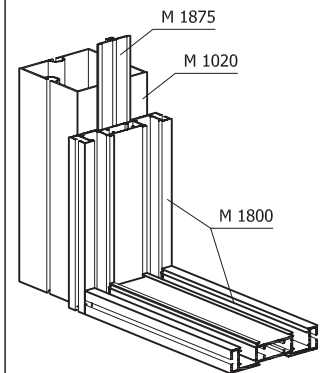

SHIM

plastic
for stabilization of assembled extrusions
in the 11 mm border area
0.002 kg

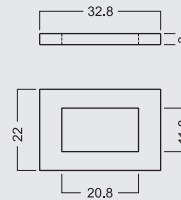
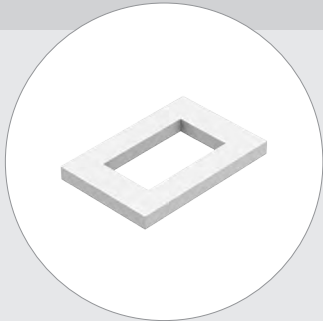

M 1855

M 1855.35

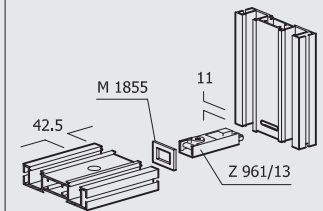

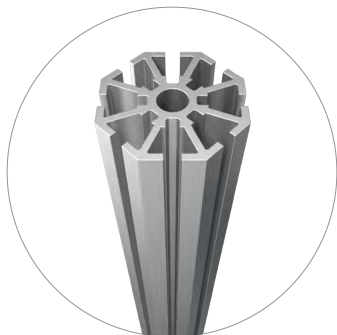

Uprights | 40 mm
102

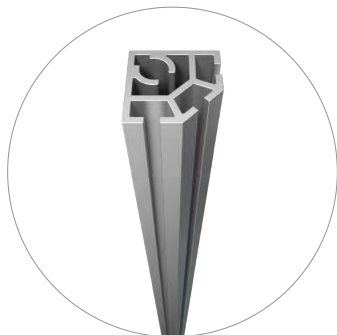

Uprights | 28 mm
106

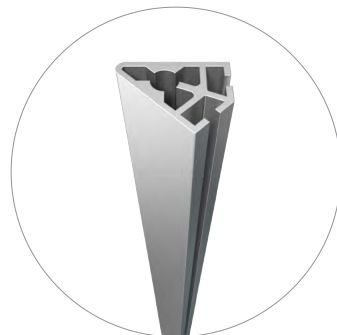

Uprights | 35 mm
107



Uprights | 32 mm
108

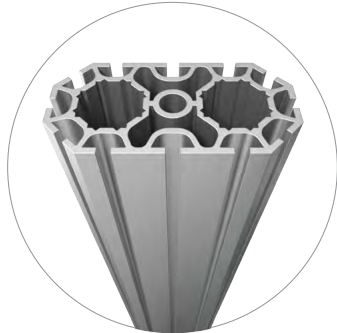

Uprights | 80 mm
109



Uprights | 40 mm
111



Uprights | 20 mm
111

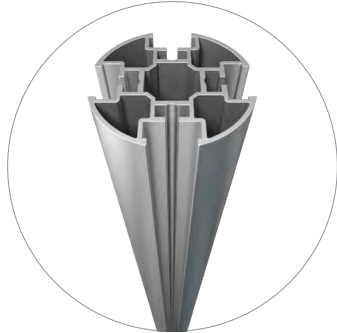

Uprights | 60 mm
112

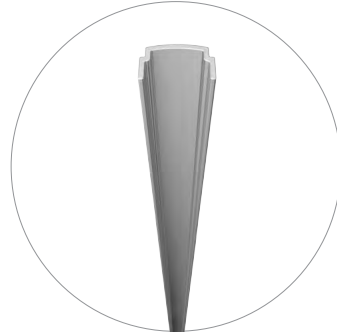

Uprights | Cover Extrusions
114



Beams | 25 mm
115

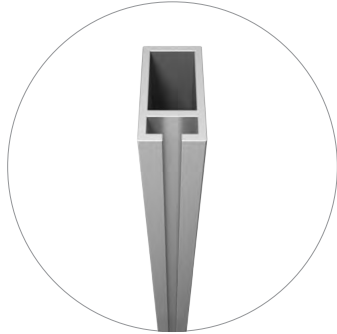

Beams | 32 mm
115

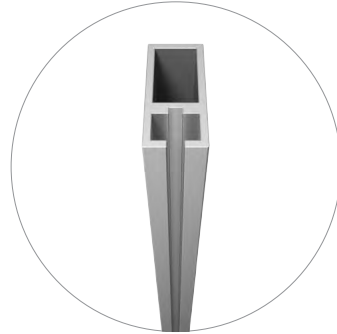

Beams | 37 mm
115



Beams | 37 mm Quarter Circle
117



Beams | 43 mm
118



Beams | 50 mm
118



Beams | 50 mm Quarter Circle

120

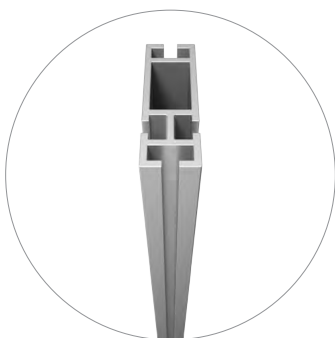

Beams | 50 mm

121



Beams | 50 mm Quarter Circle

122



Beams | 70 mm

123



Beams | 70 mm Quarter Circle

124



Beams | 70 mm

125



Beams | 70 mm Quarter Circle

126

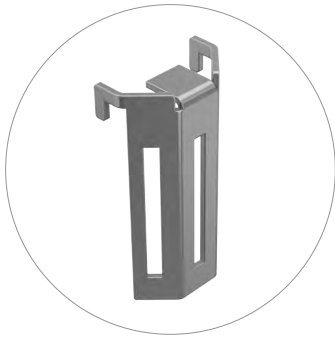

Beams | 70 mm Half Circle

127



Beams | 175 mm

127



Beams | 175 mm Quarter Circle

129



Beams | 175 mm

130



Beams | 175 mm

131

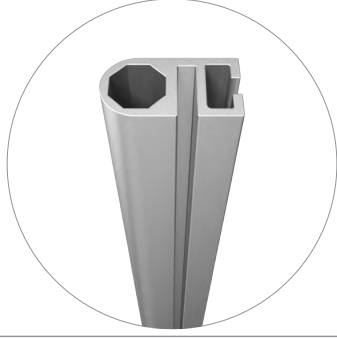

Hinged Extrusions and Connectors

134

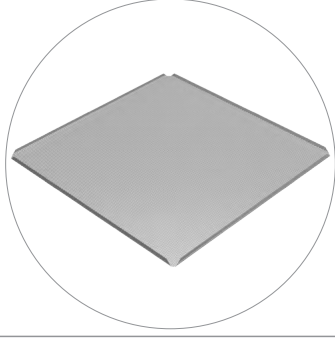

Ceiling Grids

139

UPRIGHTS

UPRIGHT EXTRUSION

aluminium
groove depth 10 mm
 5000 mm long
 6.8 kg

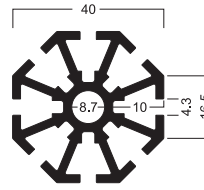

S 100

40 MM

S 100.01
 S 100.11

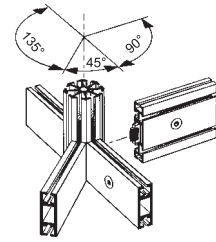

UPRIGHT

aluminium
 incl. adjustable foot S 140
2502 mm long
 3.37 kg

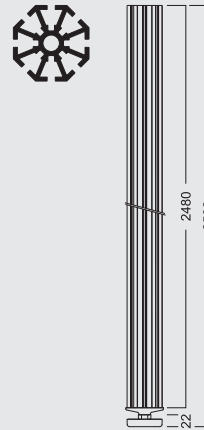
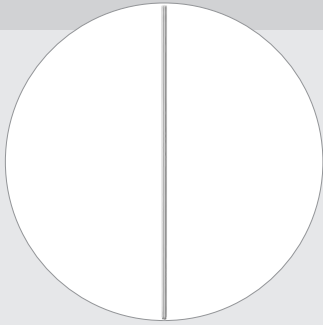

S 110

S 110.11

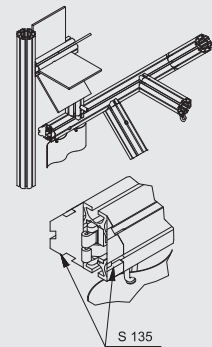

UPRIGHT EXTRUSION

aluminium
 tension lock Z 961/8 can be mounted in
 4 positions
groove depth 7 mm
 5000 mm long
 5.346 kg

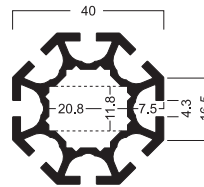

S 108

S 108.01
 S 108.11

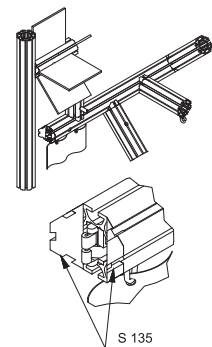

UPRIGHTS

UPRIGHT

aluminium
with adjustable foot S 140
groove depth 7 mm
2502 mm long
2.78 kg

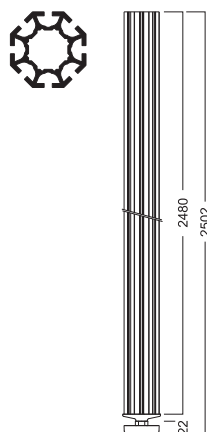
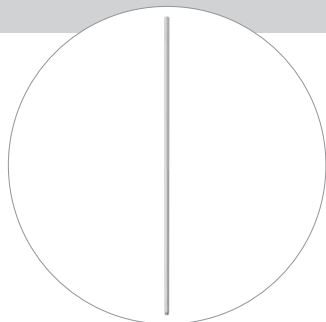

S 118

S 118.11

END CAP

plastic
for S 100 and S 108
0.004 kg

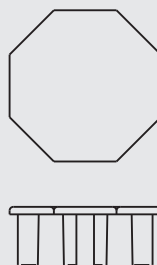

S 132

S 132.30
S 132.35

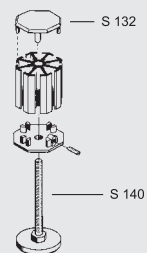

ADJUSTABLE FOOT

steel/zinc die cast
thread M8
incl. 1 set screw M 1036/20 (M4)
for S 100, S 108 and M 1204
0.117 kg

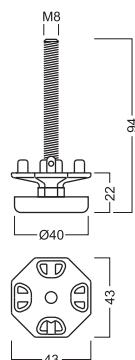

S 140

S 140.37

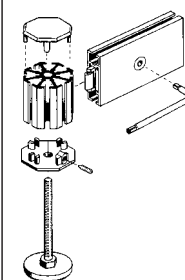

FOOT PLATE

aluminium
for adjustable feet with foot plate 40 mm
dia.
0.012 kg



S 901

S 901.01



EXHIBITION SYSTEMS

UPRIGHTS

ADAPTOR

plastic
for S 108, S 201, S 208, S 408
0.002 kg

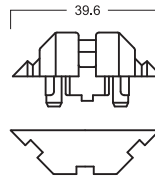

S 135

40 MM

S 135.30
S 135.35

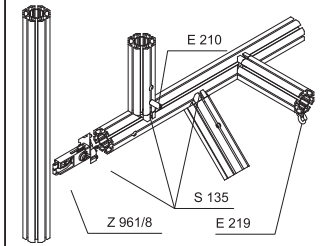

CEILING BEAM CONNECTOR, 175 MM

aluminium
incl. end cap S 132
0.234 kg

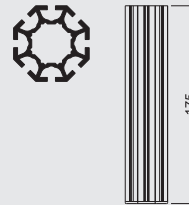
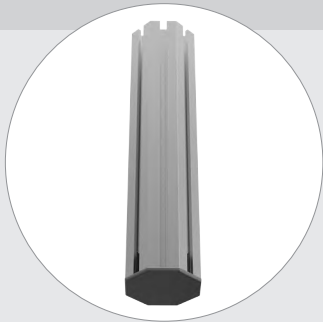

S 128

S 128.11

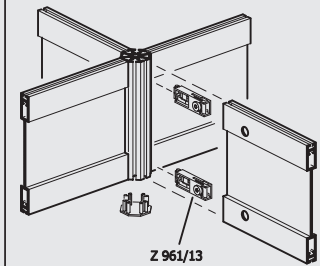

UPRIGHT EXTRUSION

aluminium
tension lock Z 961/8 can be mounted
groove depth 7 mm
5000 mm long
4.47 kg

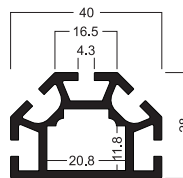

S 201

S 201.01
S 201.11

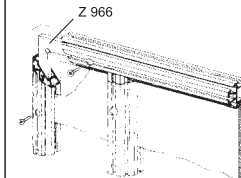

END CAP

plastic
for S 201
0.003 kg

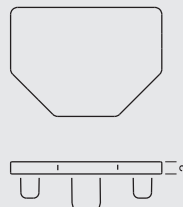

S 230

S 230.30
S 230.35

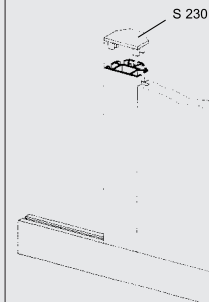

UPRIGHTS

ADJUSTABLE FOOT

zinc die cast/steel
thread M8
incl. 1 set screw M 1036/20 (M4)
for S 201
0.104 kg

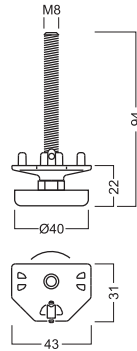

S 240

S 240.37

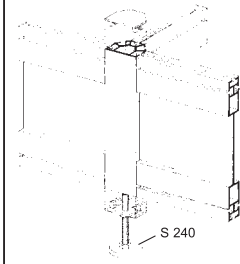

UPRIGHT EXTRUSION

aluminium
groove depth 10 mm
5000 mm long
7.2 kg

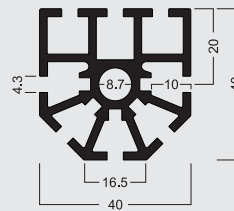

S 202

S 202.11

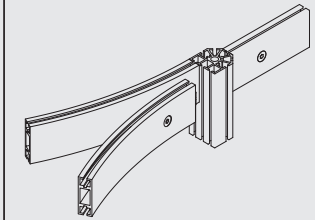

END PLATE

zinc die cast
for S 202
0.033 kg

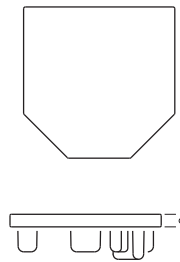

S 232

S 232.39

ADJUSTABLE FOOT

zinc die cast/steel
thread M8
incl. 1 set screw M 1036/20 (M4)
for S 202
0.103 kg

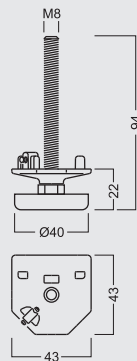
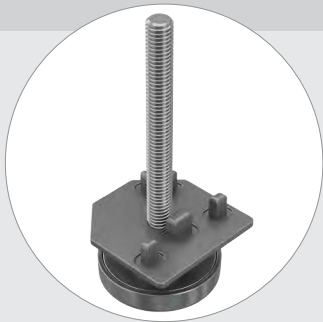

S 242

S 242.37

EXHIBITION SYSTEMS

UPRIGHTS

UPRIGHT EXTRUSION 135°

aluminium
groove depth 7 mm
5000 mm long
4.8 kg

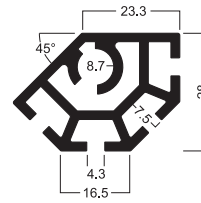

S 203

40 MM

S 203.11

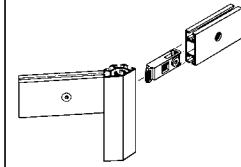

END PLATE

zinc die cast
for S 203
0.02 kg

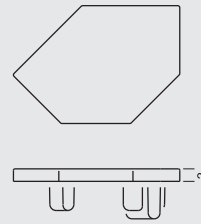

S 233

S 233.39

ADJUSTABLE FOOT

zinc die cast/steel
thread M8
incl. 1 set screw M 1036/20 (M4)
for S 203
0.097 kg

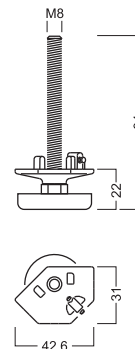

S 243

S 243.37

UPRIGHT EXTRUSION

aluminium
groove depth 7 mm
5000 mm long
4.14 kg

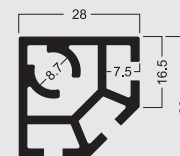

S 308

28 MM

S 308.01

S 308.11

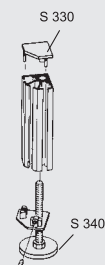

UPRIGHTS

END CAP

plastic
for S 308
0.003 kg

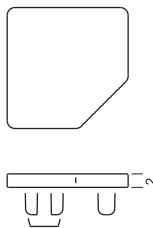

S 330

S 330.30
S 330.35

ADJUSTABLE FOOT

zinc die cast/steel
thread M8
incl. 1 set screw M 1036/20 (M4)
for S 308
0.097 kg

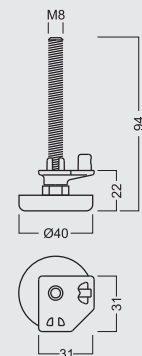
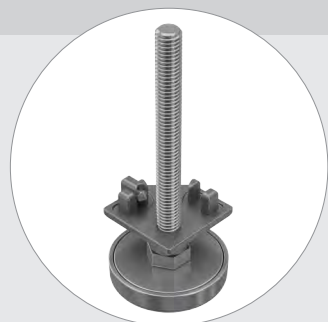

S 340

S 340.37

UPRIGHT EXTRUSION 45°

aluminium
groove depth 7 mm
5000 mm long
4.03 kg

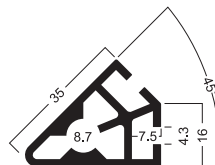

S 302

35 MM

S 302.11

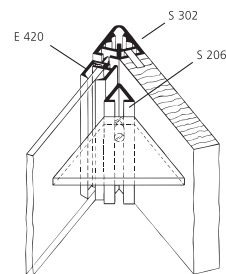

END PLATE

zinc die cast
for S 302
0.016 kg

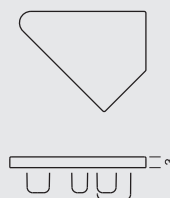

S 332

S 332.39

UPRIGHTS

ADJUSTABLE FOOT

zinc die cast/steel
thread M8
incl. 1 set screw E 212/Z (M4)
for S 302
0.092 kg

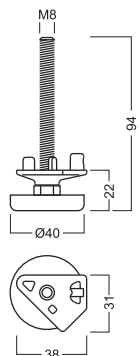

S 342

35 MM

S 342.37

UPRIGHT EXTRUSION 60°

aluminium
groove depth 7 mm
5000 mm long
4.2 kg

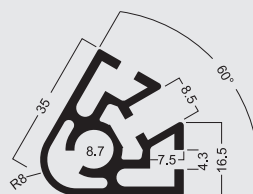

S 303

32 MM

S 303.01
S 303.11

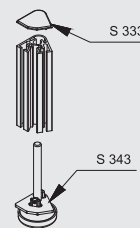

END CAP

plastic
for S 303
0.002 kg

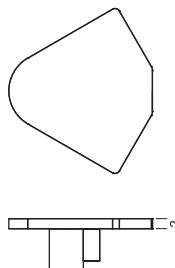

S 333

S 333.30
S 333.35

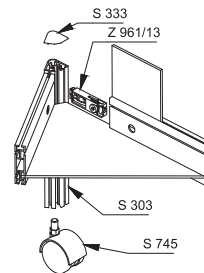

ADJUSTABLE FOOT

zinc die cast/steel
thread M8
incl. 1 set screw E 212/Z (M4)
for S 303
0.094 kg

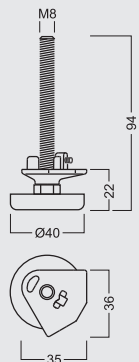

S 343

S 343.37

UPRIGHTS

UPRIGHT EXTRUSION

aluminium
tension lock Z 961/8 can be mounted in
2 positions
groove depth 7 mm
5000 mm long
12.64 kg

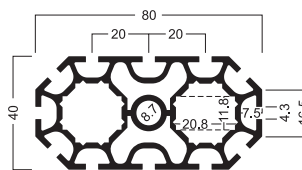

S 408

80 MM

S 408.11

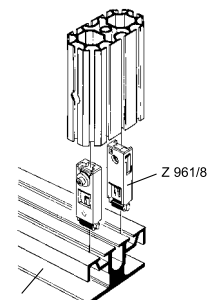

DOUBLEFORM
floor extrusion DFZ/BP
Doppelform-
Bodenprofil
DFZ/BP



END PLATE

zinc die cast
for S 408
0.059 kg

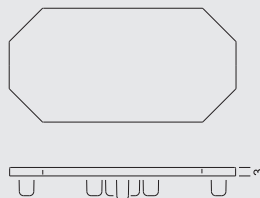

S 430

S 430.39

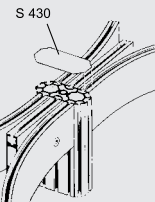

ADJUSTABLE FOOT

zinc die cast/steel
thread M8
incl. 1 set screw M 1036/20 (M4)
for S 408
0.158 kg

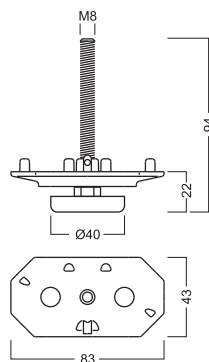
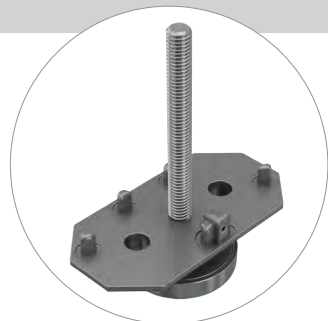

S 440

S 440.37

UPRIGHTS

UPRIGHT EXTRUSION

aluminium
tension lock Z 961/8 can be mounted in
3 positions
5000 mm long
12.2 kg

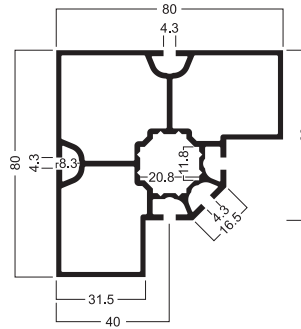
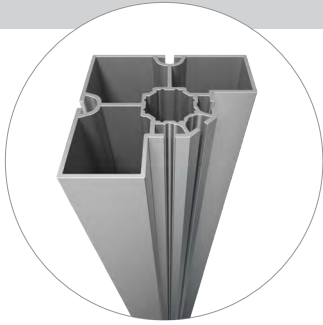

S 850 80 MM

S 850.01

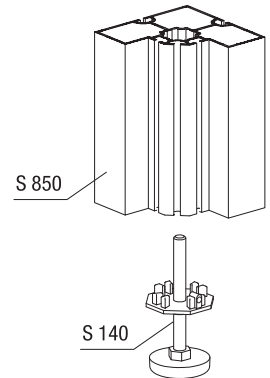

UPRIGHT EXTRUSION

aluminium
tension lock Z 961/8 can be mounted in
5 positions
5000 mm long
10.1 kg

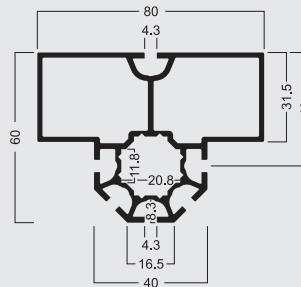

S 855

S 855.01

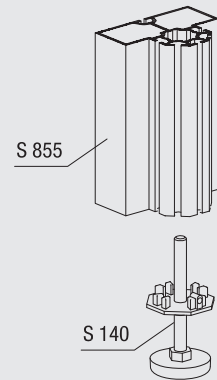

ADJUSTABLE FOOT

steel/zinc die cast
thread M8
incl. 1 set screw M 1036/20 (M4)
for S 100, S 108 and M 1204
0.117 kg

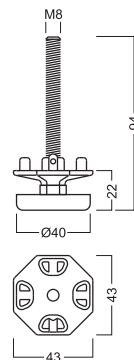

S 140

S 140.37

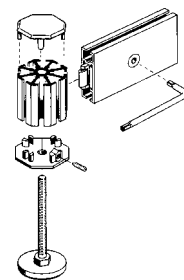

EXHIBITION SYSTEMS

UPRIGHTS

UPRIGHT EXTRUSION 60°

aluminium
groove depth 10 mm
5000 mm long
6.98 kg

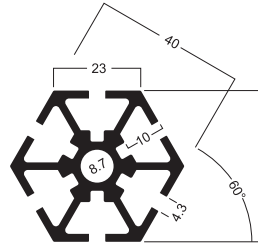

S 500

40 MM

S 500.11

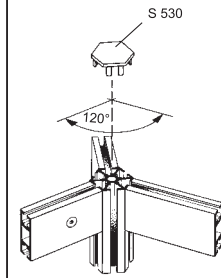

END CAP

plastic
for S 500
0.005 kg

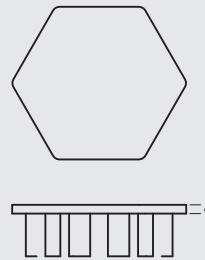

S 530

S 530.35

ADJUSTABLE FOOT

zinc die cast/steel
thread M8
incl. 1 set screw M 1036/20 (M4)
for S 500
0.11 kg

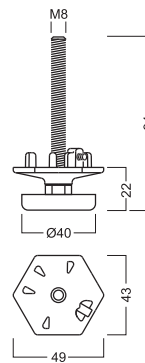

S 540

S 540.37

INTERIOR CORNER EXTRUSION 45°

aluminium
for triangular showcases using 45° angles
5000 mm long
1.41 kg



S 206

20 MM

S 206.01

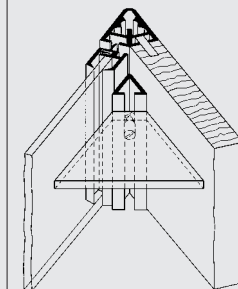

EXHIBITION SYSTEMS

UPRIGHTS

END PLATE

aluminium plate
self-adhesive, 1 mm thick
for S 206



S 236

20 MM

S 236.01

ROUND EXTRUSION 60 MM

aluminium
tension lock Z 961/8 can be mounted in
2 positions
5000 mm long
9.51 kg

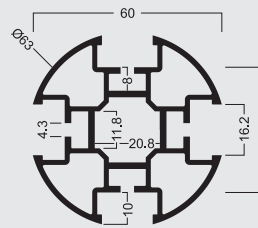

S 800

60 MM

S 800.01

16 mm panel
16 mm Füllung

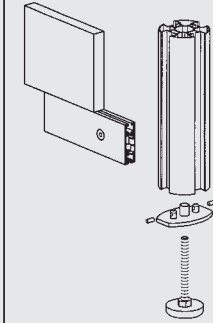

END PLATE

steel
incl. 2 set screws M 1075/20 (M4)
for S 800
0.076 kg

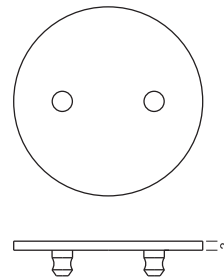

S 830

S 830.21

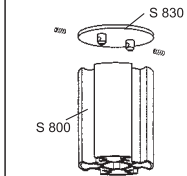

ELLIPTICAL EXTRUSION 60 X 40 MM

aluminium
tension lock Z 961/8 can be mounted in
2 positions
5000 mm long
7.58 kg

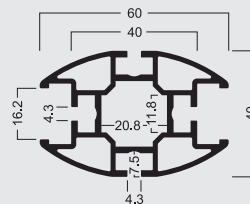
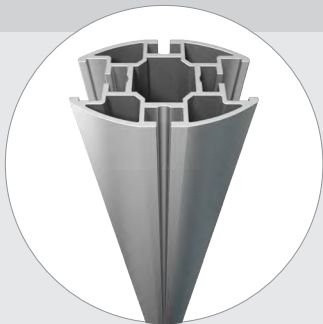

S 805

S 805.01

EXHIBITION SYSTEMS

UPRIGHTS

END PLATE

steel
incl. 2 set screws M 1075/20 (M4)
for S 805
0.053 kg

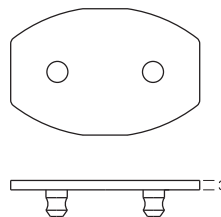

S 832

S 832.21

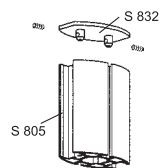

SQUARE EXTRUSION

aluminium
tension lock Z 961/8 can be mounted in
2 positions
5000 mm long
10.69 kg

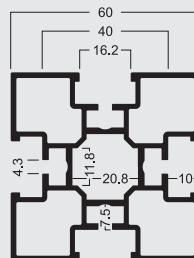
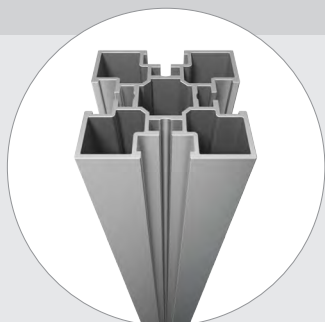

S 810

S 810.01

END PLATE

steel
incl. 2 set screws M 1075/20 (M4)
for S 810
0.089 kg

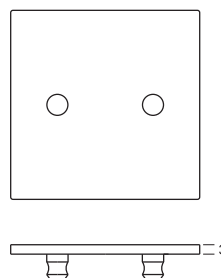

S 834

S 834.21

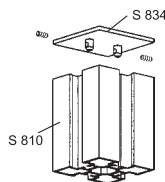

RECTANGULAR EXTRUSION 60 X 40 MM

aluminium
tension lock Z 961/8 can be mounted in
2 positions
5000 mm long
8.43 kg

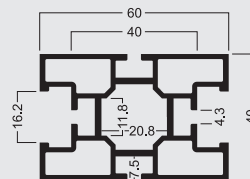
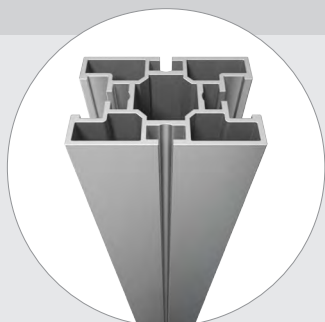

S 815

S 815.01

RECTANGULAR EXTRUSION 60 X 40 MM

aluminium
tension lock Z 961/8 can be mounted in
2 positions
6000 mm long
10.096 kg

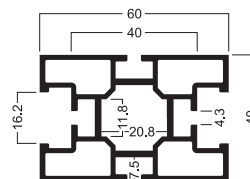
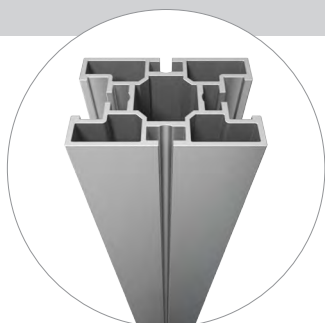

S 816

S 816.01

EXHIBITION SYSTEMS

UPRIGHTS

END PLATE

steel
incl. 2 set screws M 1075/20 (M4)
for S 815
0.061 kg

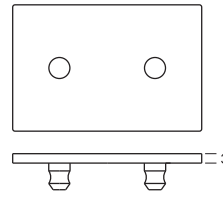
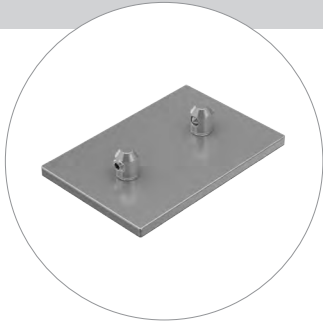

S 836

60 MM

S 836.21

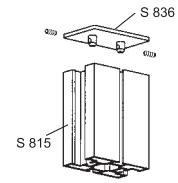

ADJUSTABLE FOOT

steel
thread M8
incl. 2 set screws M 1075/20 (M4)
for S 800, S 805, S 810, S 815
0.141 kg

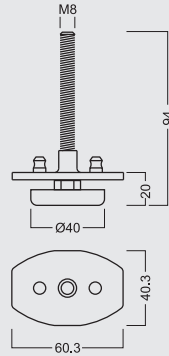

S 842

S 842.37

COVER EXTRUSION

aluminium
for extrusion S 800
optional for S 805, S 810, S 815
5000 mm long
0.68 kg

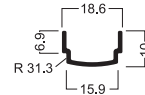

S 822

COVER EXTRUSIONS

S 822.01

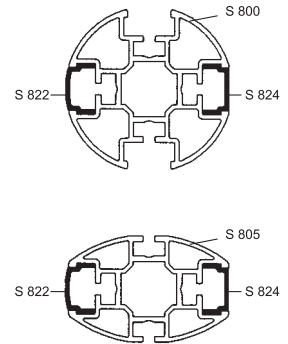

COVER EXTRUSION

aluminium
for extrusions S 810 and S 815
optional for S 800 and S 805
5000 mm long
0.67 kg

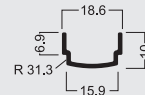

S 824

S 824.01

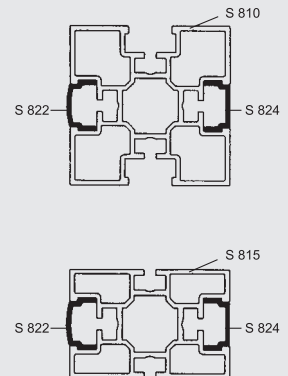

EXHIBITION SYSTEMS

BEAMS

BEAM EXTRUSION 25 MM

aluminium
tension lock Z 961/13 can be mounted
5000 mm long
2.083 kg

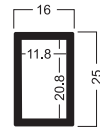

Z 300

25 MM

Z 300.01
Z 300.11

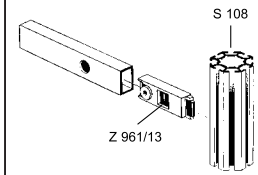

END CAP

plastic
for Z 300
0.002 kg

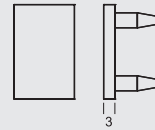

Z 970

Z 970.30
Z 970.35

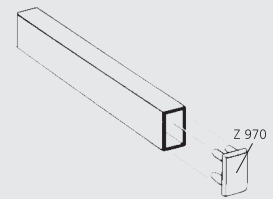

BEAM EXTRUSION 32 MM

aluminium
tension lock Z 961/13 can be mounted
groove depth 7 mm
5000 mm long
2.68 kg

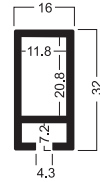

Z 308

32 MM

Z 308.01
Z 308.11

END CAP

plastic
for extrusion Z 308
0.003 kg

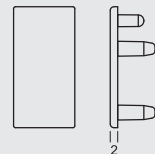

Z 976

Z 976.30
Z 976.35

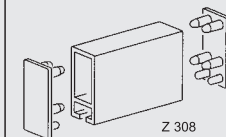

BEAM EXTRUSION 37 MM

aluminium
tension lock Z 961/13 can be mounted
groove depth 10 mm
5000 mm long
2.962 kg

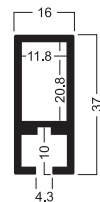

Z 310

37 MM

Z 310.01
Z 310.11

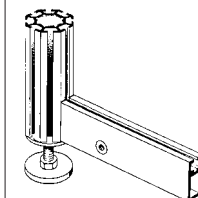

2

EXHIBITION SYSTEMS

BEAMS

END CAP

plastic
for Z 310
0.002 kg

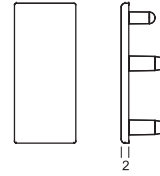

Z 974

37 MM

Z 974.30
Z 974.35

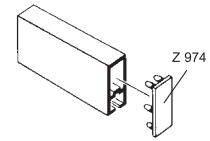

BEAM 455 X 37 MM

aluminium
incl. 2 built-in tension locks Z 961/13
455 mm long
0.454 kg

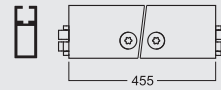

Z 315

Z 315.11

BEAM 660 X 37 MM

aluminium
incl. 2 built-in tension locks Z 961/13
660 mm long
0.602 kg

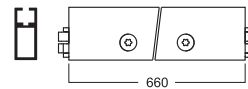

Z 320

Z 320.11

BEAM 950 X 37 MM

aluminium
incl. 2 built-in tension locks Z 961/13
950 mm long
0.791 kg

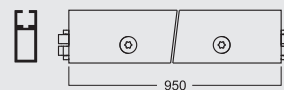
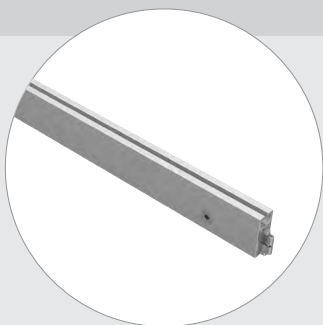

Z 325

Z 325.11

BEAM 1360 X 37 MM

aluminium
incl. 2 built-in tension locks Z 961/13
1360 mm long
1.243 kg

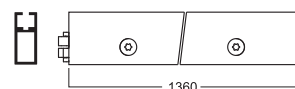

Z 330

Z 330.11

EXHIBITION SYSTEMS

BEAMS

CURVED BEAM - QUARTER CIRCLE 990 X 37 MM

aluminium
incl. 2 built-in tension locks Z 962/13
990 mm dia.
0.778 kg

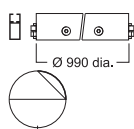

Z 350

37 MM QUARTER CIRCLE

Z 350.11

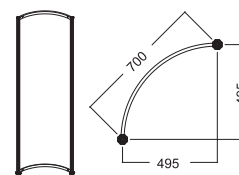

CURVED BEAM - QUARTER CIRCLE 1400 MM X 37 MM

aluminium
incl. 2 built-in tension locks Z 962/13
1400 mm dia.
0.947 kg

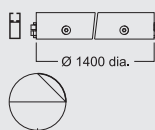

Z 351

Z 351.11

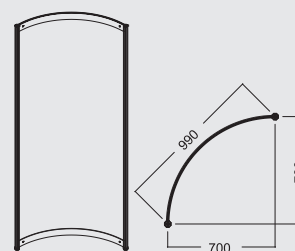

CURVED BEAM - QUARTER CIRCLE 1980 X 37 MM

aluminium
incl. 2 built-in tension locks Z 962/13
1980 mm dia.
1.227 kg

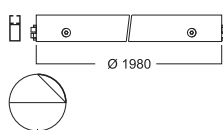

Z 352

Z 352.11

CURVED BEAM - QUARTER CIRCLE 2800 X 37 MM

aluminium
incl. 2 built-in tension locks Z 962/13
2800 mm dia.
1.789 kg

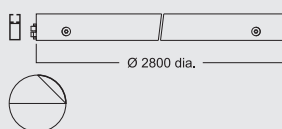

Z 353

Z 353.11

2

EXHIBITION SYSTEMS

BEAMS

BEAM EXTRUSION 43 MM

aluminium
Attention: For mounting tension lock Z 961/13 you need the adaptor Z 161/A
 5000 mm long
 3.14 kg



Z 100

43 MM

Z 100.11

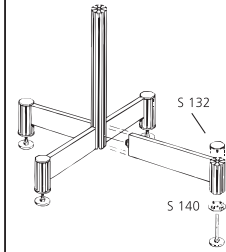

END CAP

plastic
 for Z 100
 0.004 kg

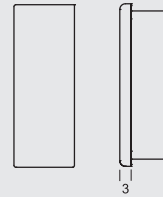

Z 170

Z 170.30
 Z 170.35

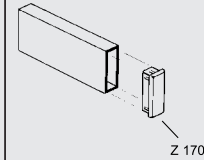

BEAM EXTRUSION 50 MM

aluminium
 mounting 2 tension locks Z 961/13 one on top of the other
 5000 mm long
 3.76 kg



Z 402

50 MM

Z 402.01
 Z 402.11

BEAM EXTRUSION 50 MM

aluminium
 tension lock Z 961/13 can be mounted
groove depth 10 mm
 5000 mm long
 4.39 kg

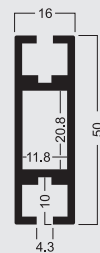

Z 400

Z 400.01
 Z 400.11

EXHIBITION SYSTEMS

BEAMS

END CAP

plastic
for Z 400 and Z 460
0.003 kg

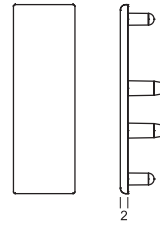
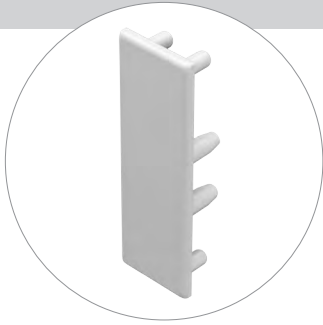

Z 975

Z 975.30
Z 975.35

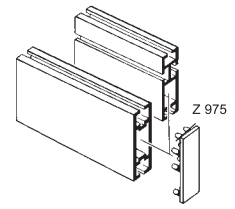

BEAM 455 X 50 MM

aluminium
incl. 2 built-in tension locks Z 961/13
455 mm long
0.496 kg

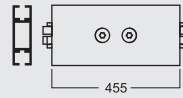
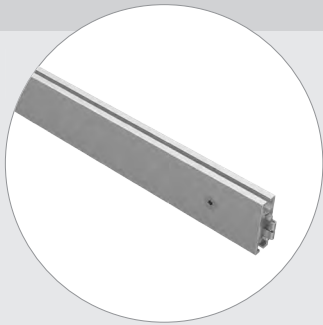

Z 415

Z 415.11

BEAM 660 X 50 MM

aluminium
incl. 2 built-in tension locks Z 961/13
660 mm long
0.749 kg

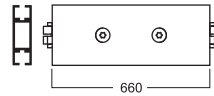

Z 420

Z 420.11

BEAM 950 X 50 MM

aluminium
incl. 2 built-in tension locks Z 961/13
950 mm long
0.995 kg

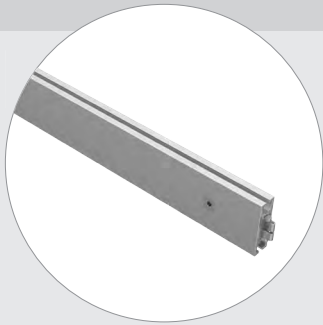

Z 425

Z 425.11

EXHIBITION SYSTEMS

BEAMS

BEAM 1360 X 50 MM

aluminium
incl. 2 built-in tension-locks Z 961/13
1360 mm long
1.583 kg

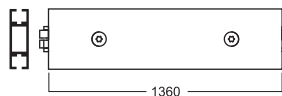

Z 430

50 MM

Z 430.11

CURVED BEAM - QUARTER CIRCLE 990 X 50 MM

aluminium
incl. 2 built-in tension locks Z 962/13
990 mm dia.
0.904 kg

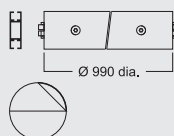

Z 450

50 MM QUARTER CIRCLE

Z 450.11

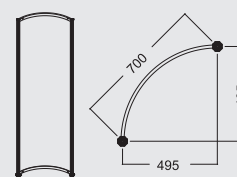

CURVED BEAM - QUARTER CIRCLE 1400 X 50 MM

aluminium
incl. 2 built-in tension locks Z 962/13
1400 mm dia.
0.982 kg

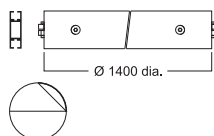

Z 451

Z 451.11

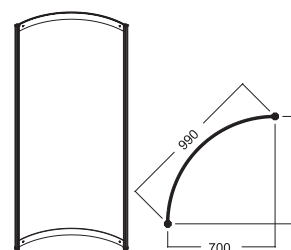

CURVED BEAM - QUARTER CIRCLE 1980 X 50 MM

aluminium
incl. 2 built-in tension locks Z 962/13
1980 mm dia.
1.437 kg

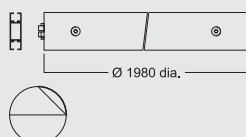

Z 452

Z 452.11

CURVED BEAM - QUARTER CIRCLE 2800 X 50 MM

aluminium
incl. 2 built-in tension locks Z 962/13
2800 mm dia.
2.299 kg

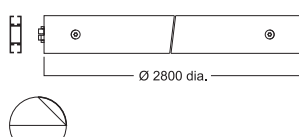

Z 453

Z 453.11

EXHIBITION SYSTEMS

BEAMS

BEAM EXTRUSION 50 MM

aluminium
tension lock Z 961/13 can be mounted
groove depth 7 mm
5000 mm long
3.955 kg

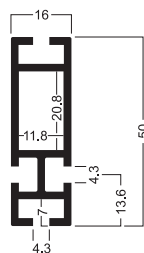
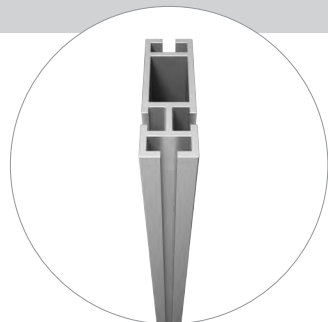

Z 460

50 MM

Z 460.01
Z 460.11

END CAP

plastic
for Z 400 and Z 460
0.003 kg

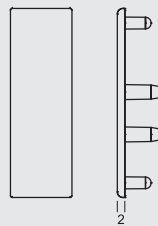
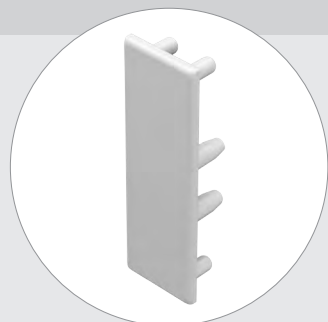

Z 975

Z 975.30
Z 975.35

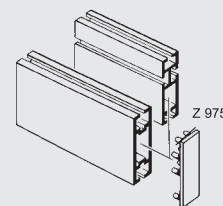

BEAM 455 X 50 MM

aluminium
incl. 2 built-in tension locks Z 961/13
455 mm long
0.541 kg

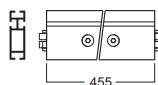

Z 416

Z 416.11

BEAM 660 X 50 MM

aluminium
incl. 2 built-in tension locks Z 961/13
660 mm long
0.728 kg



Z 421

Z 421.11

2

EXHIBITION SYSTEMS

BEAMS

BEAM 950 X 50 MM

aluminium
incl. 2 built-in tension locks Z 961/13
950 mm long
0.965 kg

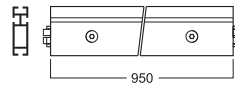

Z 426

50 MM

Z 426.11

BEAM 1360 X 50 MM

aluminium
incl. 2 built-in tension locks Z 961/13
1360 mm long
1.533 kg



Z 431

Z 431.11

CURVED BEAM-QUARTER CIRCLE 990 X 50 MM

aluminium
incl. 2 built-in tension locks Z 962/13
990 mm dia.
0.952 kg

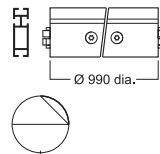

Z 440

50 MM QUARTER CIRCLE

Z 440.11

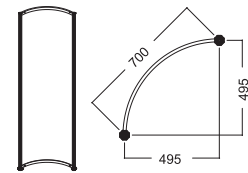

CURVED BEAM - QUARTER CIRCLE 1400 X 50 MM

aluminium
incl. 2 built-in tension locks Z 962/13
1400 mm dia.
1.164 kg

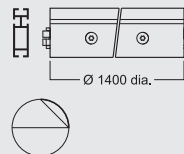

Z 441

Z 441.11

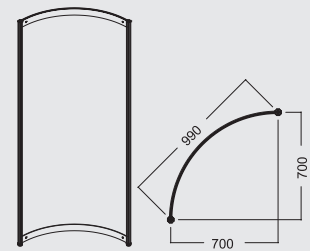

CURVED BEAM - QUARTER CIRCLE 1980 X 50 MM

aluminium
incl. 2 built-in tension locks Z 962/13
1980 mm dia.
1.517 kg

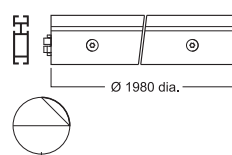

Z 442

Z 442.11

EXHIBITION SYSTEMS

BEAMS

**CURVED BEAM - QUARTER
CIRCLE 2800 X 50 MM**

aluminium
incl. 2 built-in tension locks Z 962/13
2800 mm dia.
2.224 kg

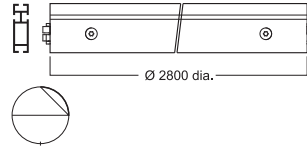

Z 443

Z 443.11

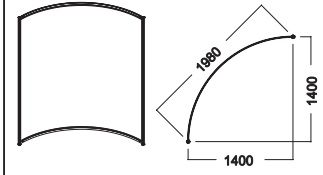

BEAM EXTRUSION 70 MM

aluminium
**Attention: For mounting tension lock
Z 961/13 the adaptor Z 161/A is needed**
groove depth 10 mm
5000 mm long
5.42 kg

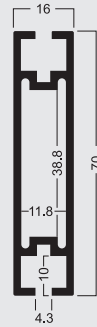

Z 110

70 MM

Z 110.01
Z 110.11

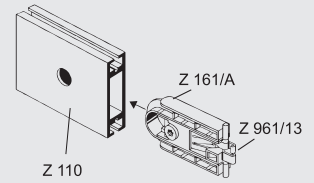

END CAP

plastic
for Z 110 and Z 160
0.003 kg

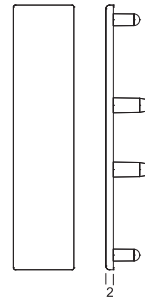
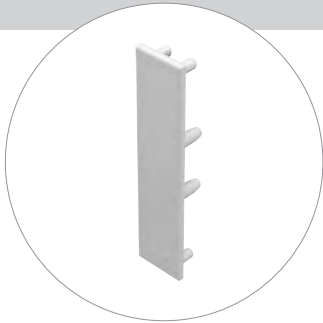

Z 175

Z 175.30
Z 175.35

BEAM 455 X 70 MM

aluminium
incl. 2 built-in tension locks Z 961/13 and
2 adaptors Z 161/A
455 mm long
0.683 kg

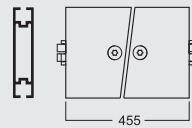

Z 115

Z 115.11

EXHIBITION SYSTEMS

BEAMS

BEAM 660 X 70 MM

aluminium
incl. 2 built-in tension locks Z 961/13 and
2 adaptors Z 161/A
660 mm long
0.922 kg

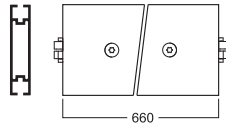

Z 120

70 MM

Z 120.11

BEAM 950 X 70 MM

aluminium
incl. 2 built-in tension locks Z 961/13 and
2 adaptors Z 161/A
950 mm long
1.225 kg

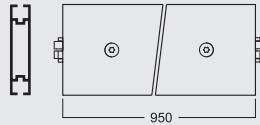
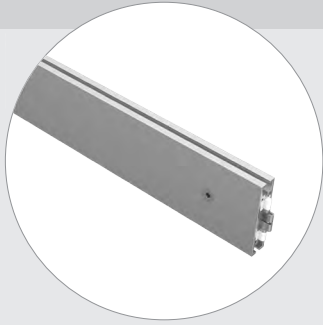

Z 125

Z 125.11

BEAM 1360 X 70 MM

aluminium
incl. 2 built-in tension locks Z 961/13 and
2 adaptors Z 161/A
1360 mm long
1.878 kg

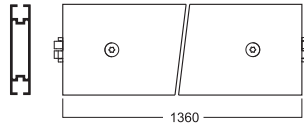

Z 130

Z 130.11

**CURVED BEAM - QUARTER
CIRCLE 990 X 70 MM**

aluminium
incl. 2 built-in tension locks Z 962/13 and
2 adaptors Z 161/A
990 mm dia.
0.91 kg

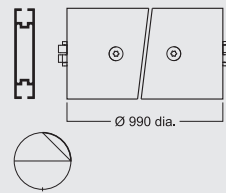

Z 150

**70 MM QUARTER
CIRCLE**

Z 150.11

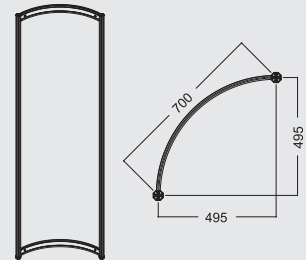

EXHIBITION SYSTEMS

BEAMS

CURVED BEAM - QUARTER CIRCLE 1400 X 70 MM

aluminium
incl. 2 built-in tension locks Z 962/13 and
2 adaptors Z 161/A
1400 mm dia.
1.13 kg

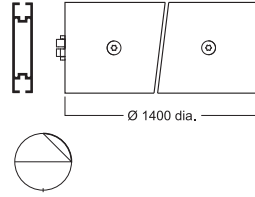

Z 151

Z 151.11

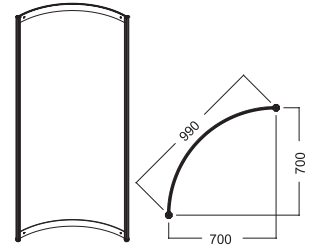

CURVED BEAM - QUARTER CIRCLE 1980 X 70 MM

aluminium
incl. 2 built-in tension locks Z 962/13 and
2 adaptors Z 161/A
1980 mm dia.
1.64 kg

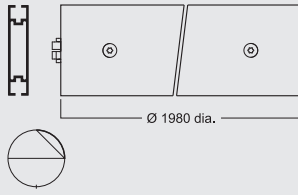

Z 152

Z 152.11

BEAM EXTRUSION 70 MM

aluminium
tension lock Z 961/13 can be mounted
groove depth 7 mm
5000 mm long
5.426 kg

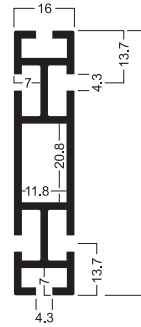

Z 160

70 MM

Z 160.01
Z 160.11

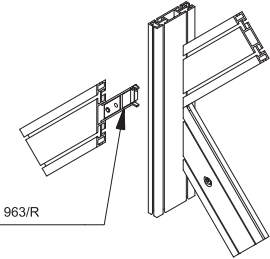

BEAM 455 X 70 MM

aluminium
incl. 2 built-in tension locks Z 961/13
455 mm long
0.66 kg

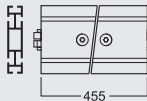
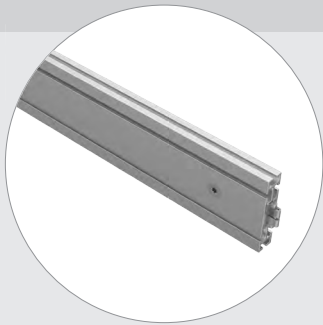

Z 116

Z 116.11

EXHIBITION SYSTEMS

BEAMS

BEAM 660 X 70 MM

aluminium
incl. 2 built-in tension locks Z 961/13
660 mm long
0.899 kg

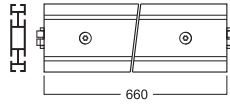
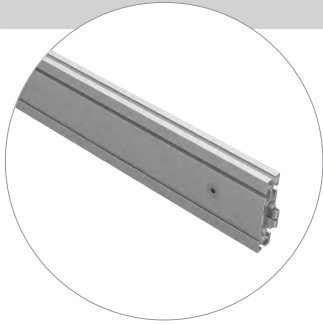

Z 121

70 MM

Z 121.11

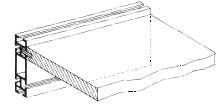

BEAM 950 X 70 MM

aluminium
incl. 2 built-in tension locks Z 961/13
950 mm long
1.202 kg

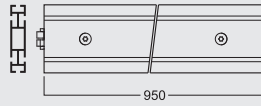
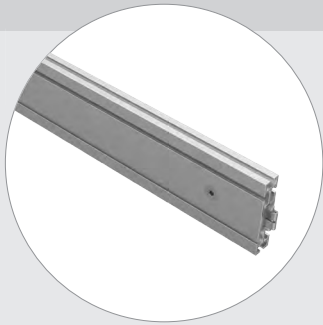

Z 126

Z 126.11

BEAM 1360 X 70 MM

aluminium
incl. 2 built-in tension locks Z 961/13
1360 mm long
1.929 kg

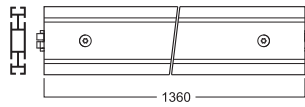
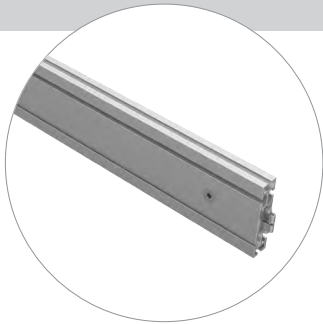

Z 131

Z 131.11

**CURVED BEAM - QUARTER
CIRCLE 990 X 70 MM**

aluminium
incl. 2 built-in tension locks Z 962/13
990 mm dia.
1.189 kg

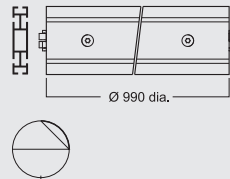

Z 140

**70 MM QUARTER
CIRCLE**

Z 140.11

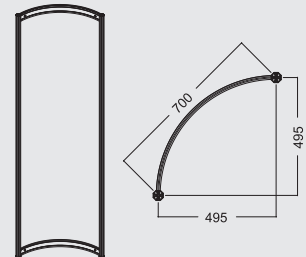

EXHIBITION SYSTEMS

BEAMS

CURVED BEAM - QUARTER CIRCLE 1400 X 70 MM

aluminium
incl. 2 built-in tension locks Z 962/13
1400 mm dia.
1.46 kg

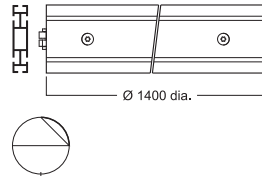

Z 141

Z 141.11

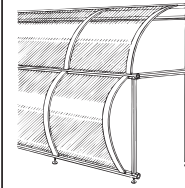

UNIVERSAL SUSPENSION CONNECTOR

steel
for Z 110 and Z 160
0.045 kg



Z 169

70 MM HALF CIRCLE

Z 169.37

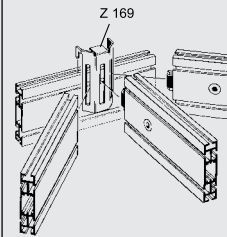

BEAM EXTRUSION 175 MM

aluminium
tension lock Z 961/13 can be mounted
groove depth 7 mm
5000 mm long
9.95 kg



Z 508

175 MM

Z 508.01
Z 508.11

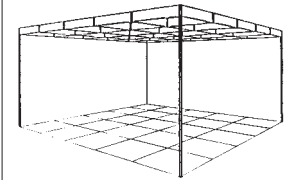

EXHIBITION SYSTEMS

BEAMS

BEAM 455 X 175 MM

aluminium
incl. 4 built-in tension locks Z 961/13
455 mm long
1.125 kg

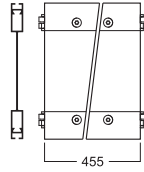

Z 514

175 MM

Z 514.11

BEAM 660 X 175 MM

aluminium
incl. 4 built-in tension-locks Z 961/13
660 mm long
1.643 kg

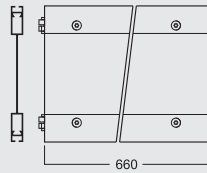

Z 519

Z 519.11

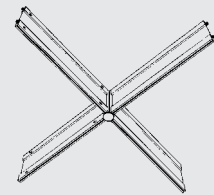

BEAM 950 X 175 MM

aluminium
incl. 4 built-in tension locks Z 961/13
950 mm long
2.224 kg

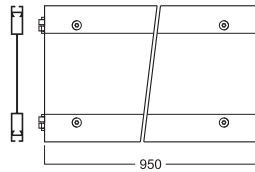

Z 524

Z 524.11

BEAM 1360 X 175 MM

aluminium
incl. 4 built-in tension locks Z 961/13
1360 mm long
3.558 kg

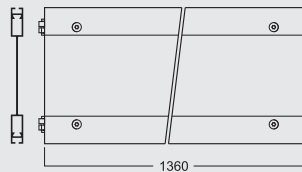
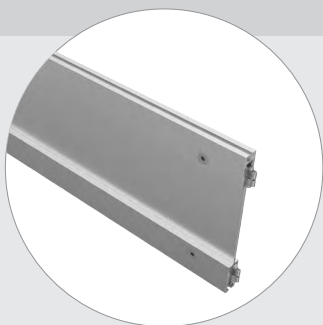

Z 529

Z 529.11

EXHIBITION SYSTEMS

BEAMS

**CURVED BEAM-QUARTER
CIRCLE 990 X 175 MM**

aluminium
incl. 4 built-in tension locks Z 962/13
990 mm dia.
2.228 kg

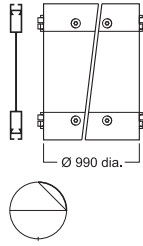

Z 590

**175 MM
QUARTER CIRCLE**

Z 590.11

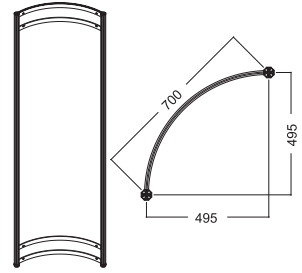

**CURVED BEAM-QUARTER
CIRCLE 1400 X 175 MM**

aluminium
incl. 4 built-in tension locks Z 962/13
1400 mm dia.
2.733 kg

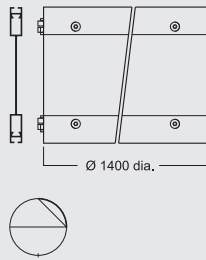

Z 591

Z 591.11



**CURVED BEAM-QUARTER
CIRCLE 1980 X 175 MM**

aluminium
incl. 4 built-in tension locks Z 962/13
1980 mm dia.
3.575 kg

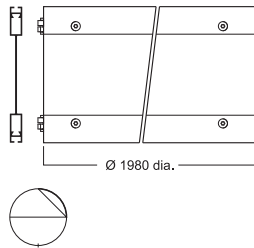

Z 592

Z 592.11

**CURVED BEAM-QUARTER
CIRCLE 2800 X 175 MM**

aluminium
incl. 4 built-in tension locks Z 962/13
2800 mm dia.
5.258 kg

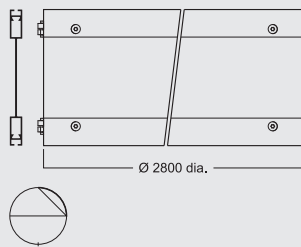

Z 593

Z 593.11

BEAMS

BEAM EXTRUSION 175 MM

aluminium
tension lock Z 961/13 can be mounted
groove depth 7 mm
5000 mm long
10.32 kg



Z 560

175 MM

Z 560.01
Z 560.11

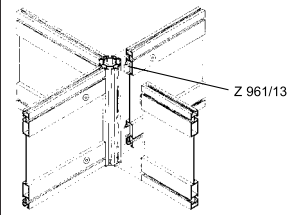

BEAM 455 X 175 MM

aluminium
incl. 4 built-in tension locks Z 961/13
455 mm long
1.266 kg

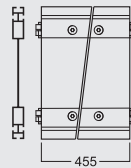
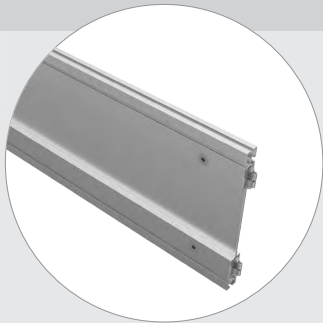

Z 516

Z 516.11

BEAM 660 X 175 MM

aluminium
incl. 4 built-in tension locks Z 961/13
660 mm long
1.72 kg

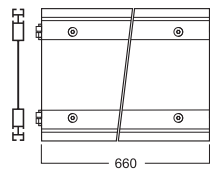

Z 521

Z 521.11

EXHIBITION SYSTEMS

BEAMS

BEAM 950 X 175 MM

aluminium
incl. 4 built-in tension locks Z 961/13
950 mm long
2.298 kg

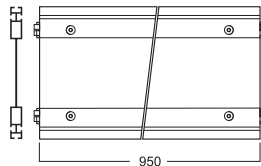

Z 526

Z 526.11

BEAM 1360 X 175 MM

aluminium
incl. 4 built-in tension locks Z 961/13
1360 mm long
3.681 kg

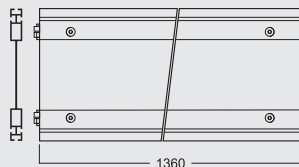
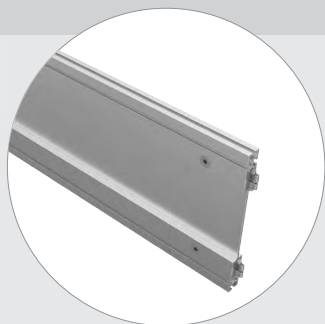

Z 531

Z 531.11

BEAM EXTRUSION 175 MM

aluminium
up to 4 tension locks Z 961/13 can be mounted
groove depth 10 mm
5000 mm long
13.53 kg



Z 600

175 MM

Z 600.01
Z 600.11

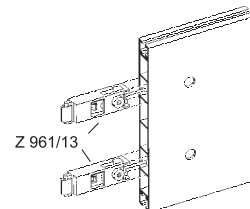

2

EXHIBITION SYSTEMS

BEAMS

BEAM 455 X 175 MM

aluminium
incl. 4 built-in tension locks Z 961/13
455 mm long
1.587 kg

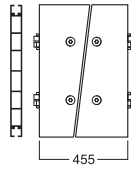

Z 615

175 MM

Z 615.11

BEAM 660 X 175 MM

aluminium
incl. 4 built-in tension locks Z 961/13
660 mm long
2.183 kg

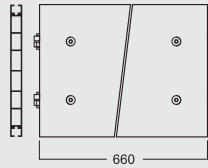

Z 620

Z 620.11

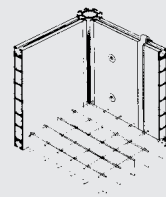

BEAM 950 X 175 MM

aluminium
incl. 4 built-in tension locks Z 961/13
950 mm long
2.94 kg

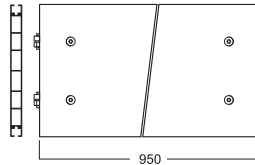
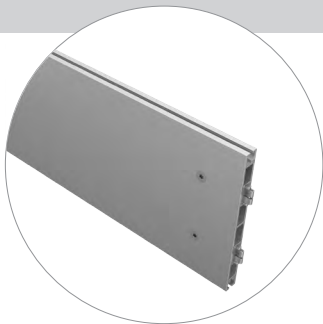

Z 625

Z 625.11

BEAM 1360 X 175 MM

aluminium
incl. 4 built-in tension locks Z 961/13
1360 mm long
3.58 kg

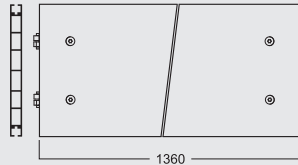
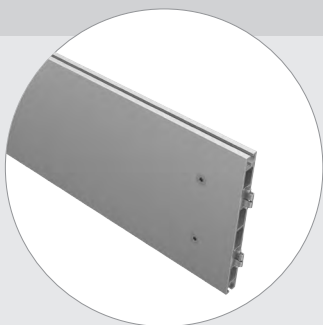

Z 630

Z 630.11

BEAMS

UNIVERSAL
SUSPENSION CONNECTOR

steel
for all 175 mm beams
0.107 kg



Z 969

Z 969.37

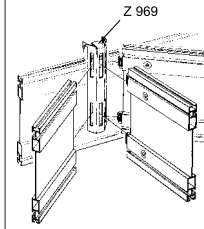

EXHIBITION SYSTEMS

**HINGED EXTRUSIONS
AND CONNECTORS**

HINGED EXTRUSION 35 MM

aluminium
5000 mm long
3.14 kg

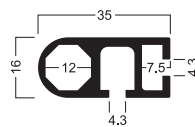

S 250

S 250.01
S 250.11

END CAP

plastic
for S 250
0.002 kg

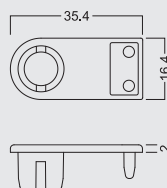

S 257

S 257.35

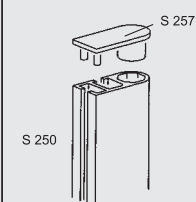

HINGED EXTRUSION 24 MM

aluminium
5000 mm long
2.24 kg

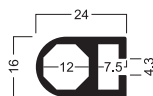

S 251

S 251.01
S 251.11

END CAP

plastic
for S 251

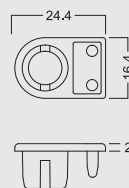

S 255

S 255.35

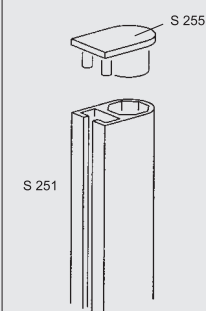

EXHIBITION SYSTEMS

HINGED EXTRUSIONS AND CONNECTORS

HINGED EXTRUSION 16 MM

aluminium
5000 mm long
1.73 kg

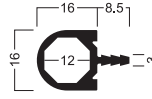

S 252

S 252.01
S 252.11

HINGED CONNECTOR

steel
thread M8, incl. retaining ring S 271
for 2 extrusions S 250 - S 252, S 280
0.052 kg

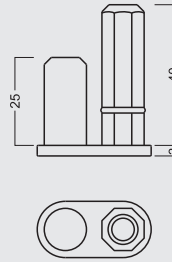

S 260

S 260.37

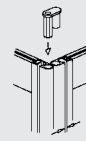

THREADED INSERT

steel
thread M8, incl. retaining ring S 271
for extrusions S 250 - S 252, S 280
0.025 kg

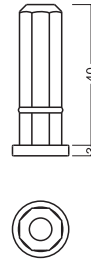

S 261

S 261.37



COUPLING SPIGOT

steel
for 2 extrusions S 250 - S 252, S 280
0.077 kg

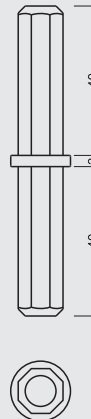

S 262

S 262.37

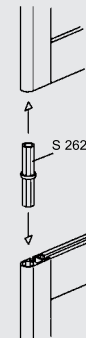

2

EXHIBITION SYSTEMS

HINGED EXTRUSIONS AND CONNECTORS

HINGED CONNECTOR

steel
thread M8, incl. S 271
for 3 extrusions S 250 - S 252, S 280
0.078 kg

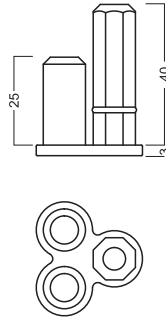

S 263

S 263.37



HINGED CONNECTOR

steel
for 4 extrusions S 250 - S 252, S 280
0.126 kg

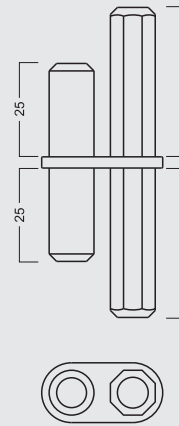
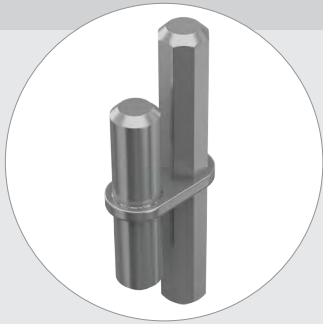

S 264

S 264.37

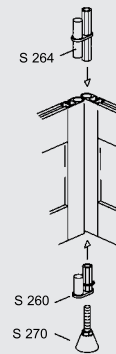

HINGED CONNECTOR

steel
for 6 extrusions S 250 - S 252, S 280
0.174 kg

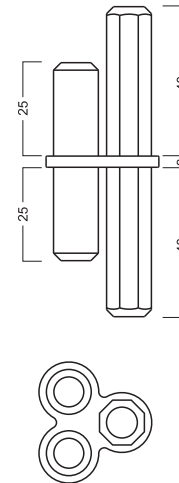

S 266

S 266.37

ADJUSTABLE FOOT

steel
thread M8 (50 mm long)
height adjustable from 28 to 68 mm
0.058 kg

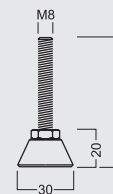
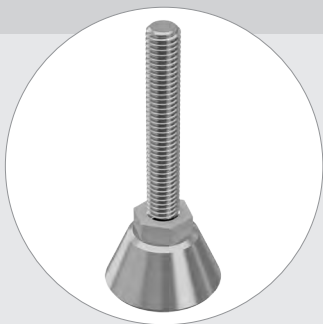

S 270

S 270.37

EXHIBITION SYSTEMS

HINGED EXTRUSIONS AND CONNECTORS

RETAINING RING

rubber
to ensure that S 260, S 261, S 263 fit tightly
in hinged extrusions S 250 - S 252



S 271

S 271.33

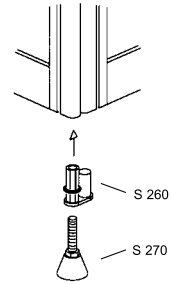

HINGED EXTRUSION

aluminium
two-parts
5000 mm long
5.602 kg

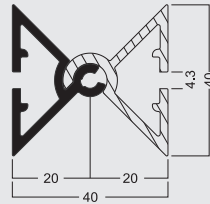

W 908

W 908.01

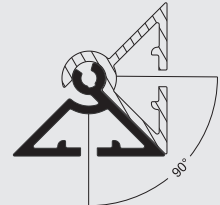

HINGED EXTRUSION

aluminium
two-parts
5000 mm long
7.641 kg



S 253

S 253.01

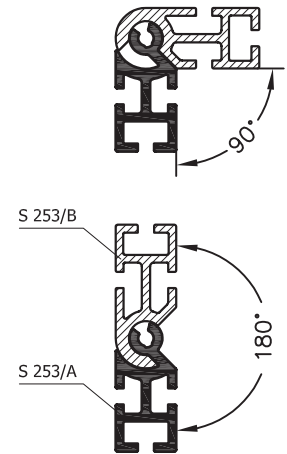

END CAP

plastic
3 parts
for extrusions S 253
0.004 kg

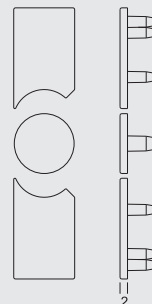
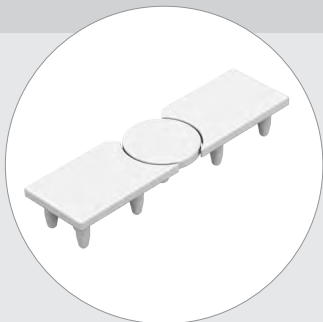

S 258

S 258.35

HINGED EXTRUSIONS
AND CONNECTORS

ADJUSTABLE FOOT

steel
two parts
thread M5 (15 mm long)
height adjustable from 26.5 to 36 mm
0.062 kg

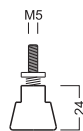

S 272

S 272.37



EXHIBITION SYSTEMS

CEILING GRIDS

PERFORATED CEILING GRID

sheet metal
holes 4 mm dia.
(percentage of perforation 40%)
3.76 kg

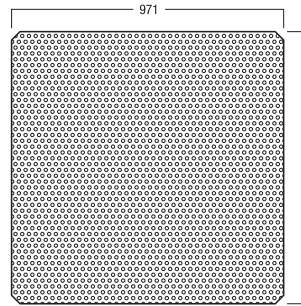
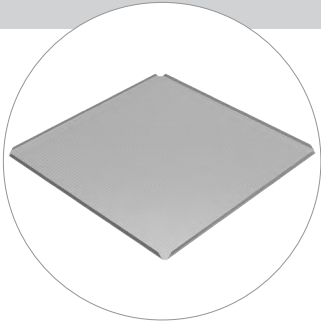

D 155

D 155.20

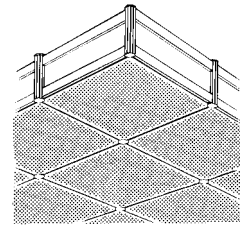

2

CEILING PANEL RETAINER

spring steel
22 mm support **on both sides**
can be fixed in system groove of all beam
extrusions
0.005 kg

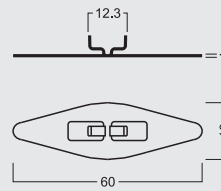

E 225

E 225.37

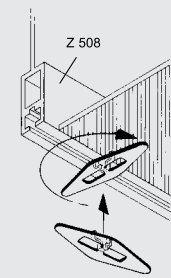

CEILING PANEL RETAINER

spring steel
22 mm support **on one side only**
can be fixed in system groove of all beam
extrusions
0.004 kg

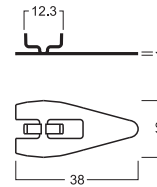

E 226

E 226.37



Fabric tension extrusions
142



Fabric extrusions for light box
157



Fabric Suspension Systems
160

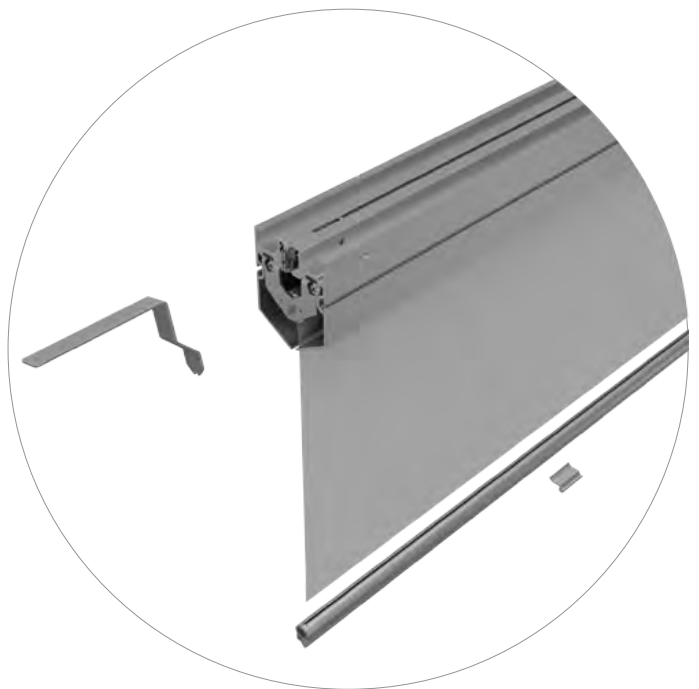

Roll-Down Wall
163



Banner Suspension Extrusions

164



Magnet retainer systems

167

3

FABRIC SUSPENSION SYSTEMS

FABRIC TENSION EXTRUSIONS

FABRIC TENSION EXTRUSION 40 MM

aluminium
to fix fabric panels to one side or on both sides
in connection with silicone edge M 1313
with 13 holes 18 mm dia.
for mounting in system groove with M 1345
6000 mm long
2.757 kg

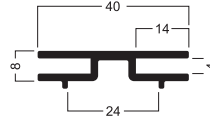
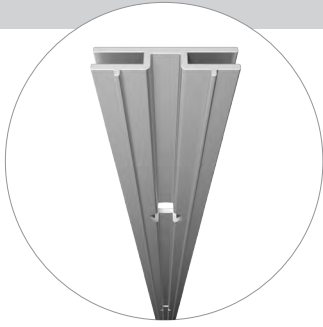

M 1310

M 1310.01

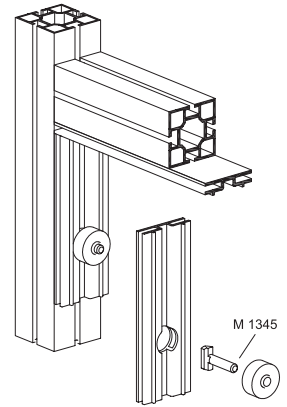

FABRIC TENSION EXTRUSION 80 MM

aluminium
to fix fabric panels to one side or on both sides
in connection with silicone edge M 1313
with 13 holes 18 mm dia.
for mounting in system groove with M 1345
6000 mm long
5.406 kg



M 1325

M 1325.01

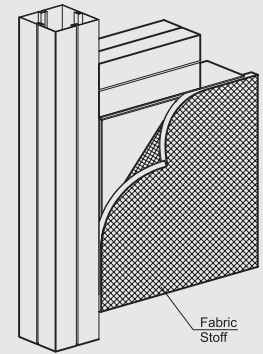

FABRIC TENSION EXTRUSION 120 MM

aluminium
to fix fabric panels to one side or on both sides
in connection with silicone edge M 1313
with 13 holes 18 mm dia.
for mounting in system groove with M 1345
6000 mm long
8.448 kg

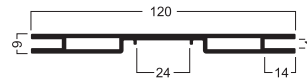

M 1330

M 1330.01

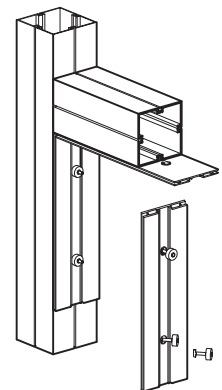

FABRIC SUSPENSION SYSTEMS

FABRIC TENSION EXTRUSIONS

FIXING-SET

steel
two parts
with hammerhead screw M 1345/Ha
"gunmetal finish"
only for fixing of extrusions
M 1310, M 1325, M 1330
to system groove 4.3 mm
0.039 kg

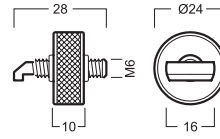

M 1345

M 1345.37

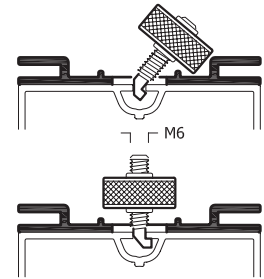
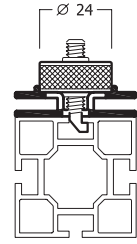

3

CONNECTION EXTRUSION

aluminium
5000 mm long
1.422 kg

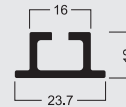
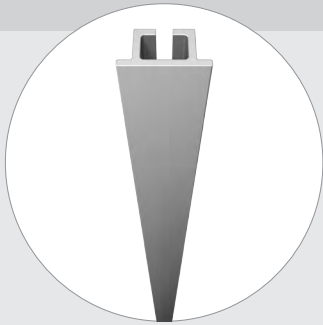

M 1311

M 1311.01

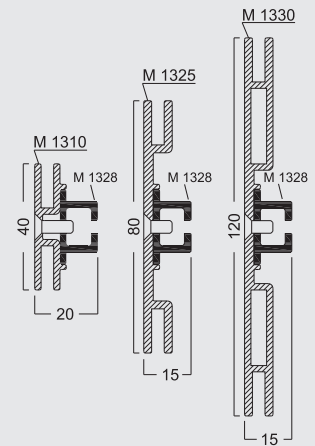

FABRIC TENSION EXTRUSIONS

ADAPTOR

aluminium
incl. 2 countersunk screws S 6132/20 (M4)
for reinforcement of frame constructions,
to fix on extrusion M 1310, M 1325, M 1330
80 mm long
0.029 kg

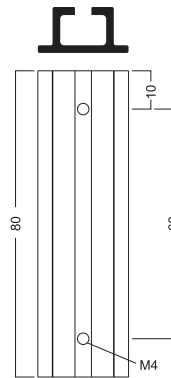
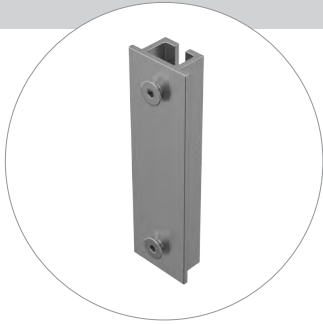

M 1328

M 1328.01

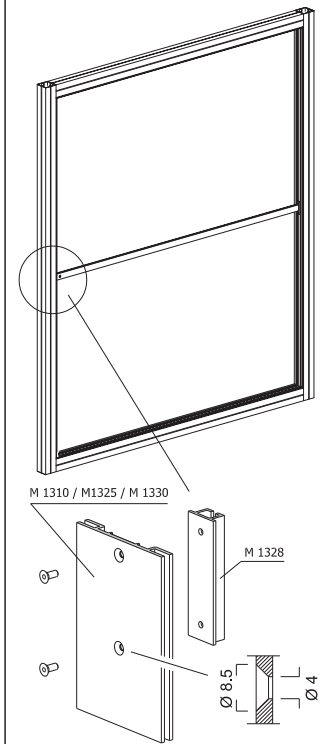

FABRIC TENSION EXTRUSION

aluminium
to fix fabric panels in connection with
silicone edge M 1313
with 11 holes 8.9 x 18 mm
for mounting in system groove
for **40 mm** square extrusions use
fixing set **M 1348**
for **80 mm and 120 mm** square extrusions
use fixing clip **M 1339** and
fixing set **M 1348**
6000 mm long
2.399 kg

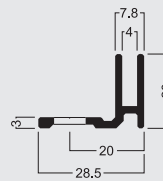

M 1322

M 1322.01

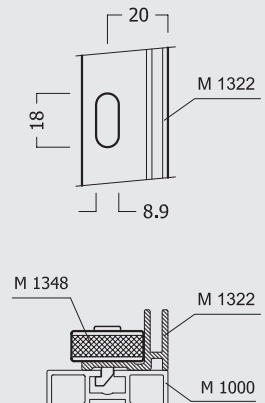

FABRIC SUSPENSION SYSTEMS

FABRIC TENSION EXTRUSIONS

FABRIC TENSION EXTRUSION, EXTERNAL CORNER

aluminium
with 2 fabric retaining grooves 90° elbow
to fix fabric panels in connection with
silicone edge M 1313
with 11 holes 8.9 x 18 mm
for mounting in system groove
for **40 mm** square extrusions use
fixing set **M 1348**
for **80 mm and 120 mm** square extrusions
use fixing clip **M 1339** and
fixing set **M 1348**
6000 mm long
4.424 kg

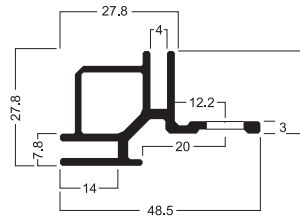
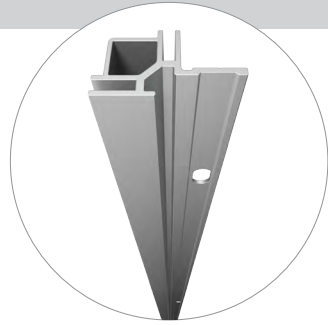

M 1322/E

M 1322/E.01

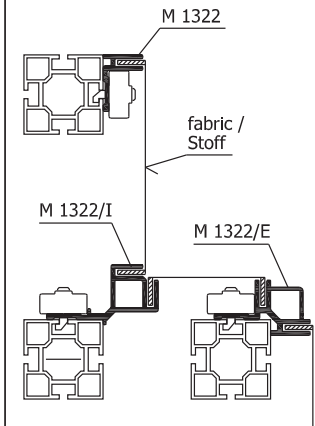

FABRIC TENSION EXTRUSION, INTERNAL CORNER

aluminium
with 2 fabric retaining grooves 90° elbow
to fix fabric panels in connection with
silicone edge M 1313
with 11 holes 8.9 x 18 mm
for mounting in system groove
for **40 mm** square extrusions use
fixing set **M 1348**
for **80 mm and 120 mm** square extrusions
use fixing clip **M 1339** and
fixing set **M 1348**
6000 mm long
4.614 kg

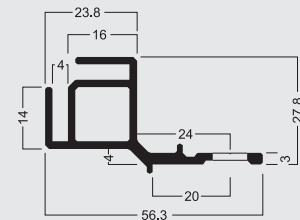

M 1322/I

M 1322/I.01

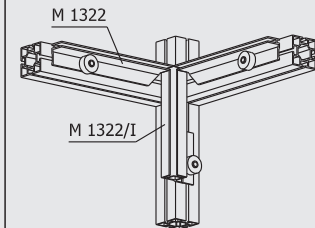

FABRIC TENSION EXTRUSION 45°

aluminium
to fix fabric panels in connection with
silicone edge M 1313
with 11 holes 8.9 x 18 mm
for mounting in system groove
for **40 mm** square extrusions use
fixing set **M 1348**
for **80 mm and 120 mm** square extrusions
use fixing clip **M 1339** and
fixing set **M 1348**
6000 mm long
2.292 kg

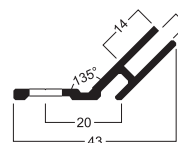

M 1321

M 1321.01

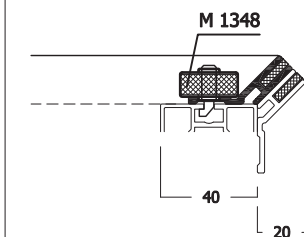

3

FABRIC SUSPENSION SYSTEMS

FABRIC TENSION EXTRUSIONS

FIXING CLIP

steel
for mounting extrusions M 1321, M 1322, M 1322/E, M 1322/I to system groove 4.3 mm
for 80 and 120 mm extrusions
0.037 kg

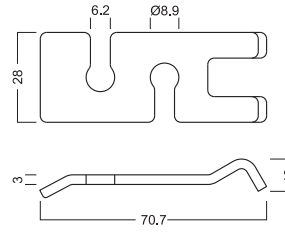

M 1339

M 1339.37

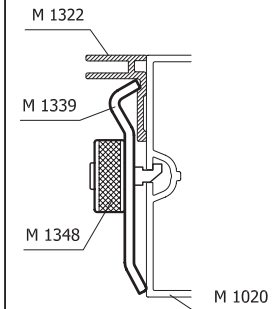

FIXING SET

steel
two-parts
with **galvanized** hammerhead screw
M 1348/Ha
only for mounting of extrusion
M 1321, M 1322, M 1322/I, M 1322/E
to system groove 4.3 mm
0.038 kg

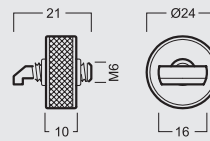

M 1348

M 1348.37

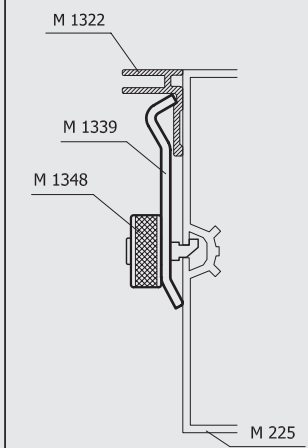

FABRIC TENSION EXTRUSION

plastic, hard
with double fabric retaining groove
to fix fabric panels in connection with
silicone edge M 1313
6000 mm long
1.46 kg



M 1319

M 1319.35

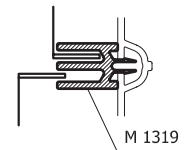

FABRIC TENSION EXTRUSION 40 MM

aluminium
with 4 grooves to fix fabric panels in
connection with silicone edge M 1313
tension lock Z 961/8 can be mounted in
2 positions
6000 mm long
8.204 kg

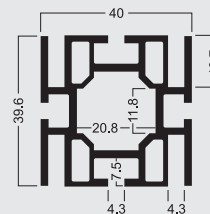

M 1305

M 1305.01

FABRIC SUSPENSION SYSTEMS

FABRIC TENSION EXTRUSIONS

FABRIC TENSION EXTRUSION

aluminium
to fix fabric panels on one side or on both sides in connection with silicone edge M 1313
6000 mm long
5.623 kg

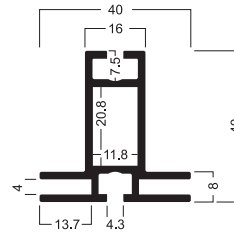
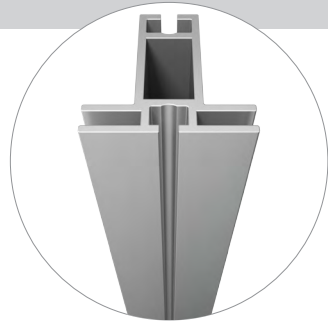

M 1307

M 1307.01

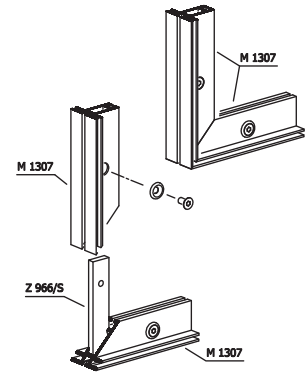

FABRIC TENSION EXTRUSION

aluminium
to fix fabric panels on one side or on both sides in connection with silicone edge M 1313
6000 mm long
10.667 kg

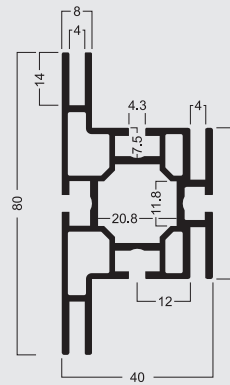

M 1304

M 1304.01

FIXING SET

steel
for quick mounting of extrusion M 1307 and M 1304 to system groove 4.3 mm
0.048 kg

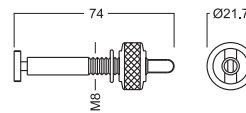

M 1478

M 1478.37

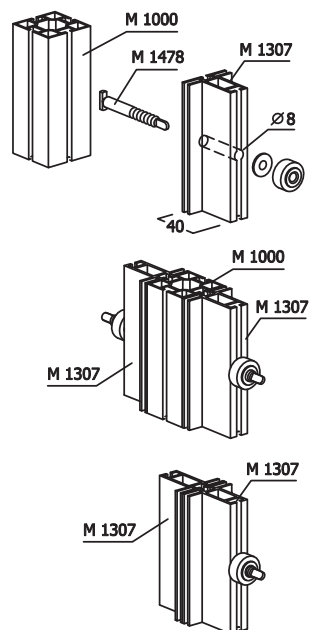

FABRIC SUSPENSION SYSTEMS

FABRIC TENSION EXTRUSIONS

BASE PLATE 320 X 120 MM

steel
for frames made out of M 1307
with screw set M 1347/SK
2.573 kg

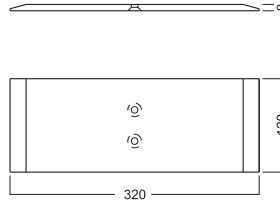

M 1398

M 1398.21

BASE PLATE

steel
without screw set
for small frames made of M 1307 and
S 1605
5.825 kg

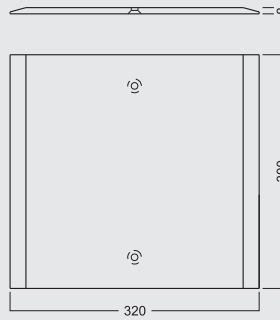
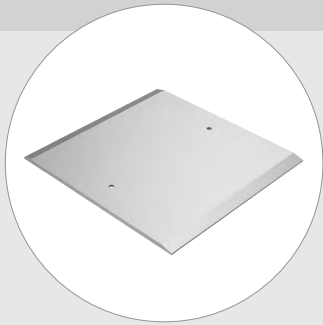

M 1357

M 1357.21

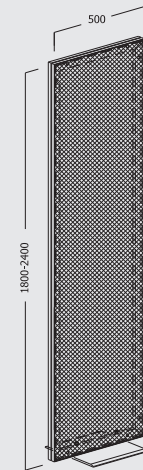
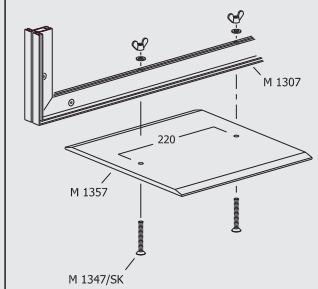

FIXING SET

steel
accessory for base plate M 1357
suitable for extrusion M 1307
0.073 kg

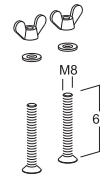

M 1347/SK

M 1347/SK.90

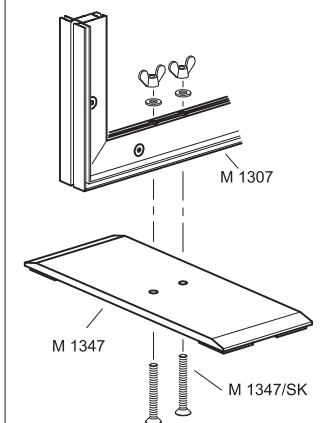

FABRIC SUSPENSION SYSTEMS

FABRIC TENSION EXTRUSIONS

BASE PLATE 495 X 170 MM

steel
incl. mounting parts M 1951BS
for free standing frames made from
extrusions M 1305, M 1307, W 820,
W 825, W 830, W 907
for side mounting and additional
connecting to bottom beam
max. frame height = 2000 mm
5.803 kg

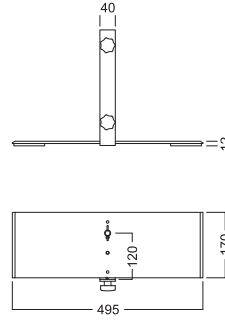

M 1941

M 1941.21

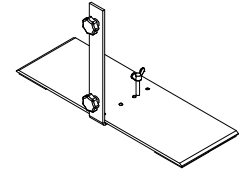

BASE PLATE 495 X 170 MM

steel
incl. mounting parts M 1951BS
for free standing frames made from
extrusions M 1308
for side mounting and additional
connecting to bottom beam
max. frame height = 2000 mm
6.527 kg

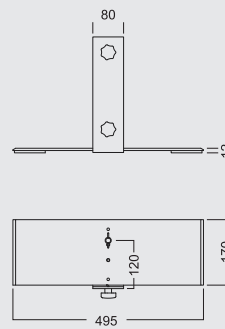
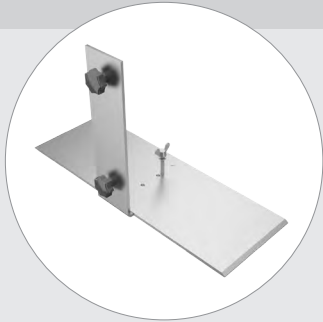

M 1942

M 1942.21

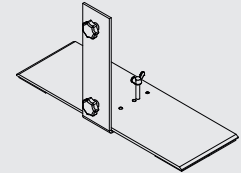

BASE PLATE 495 X 170 MM

steel
incl. mounting parts M 1953BS
for free standing frames made from
extrusions M 1305, M 1307, M 1308,
W 820, W 825, W 830, W 907
additional center base plate for
connecting to bottom beam
Attention:
for use only with M 1941, M 1942
max. frame height = 2000 mm
5.05 kg

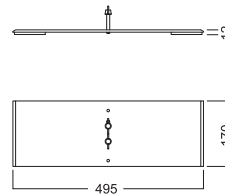

M 1943

M 1943.21

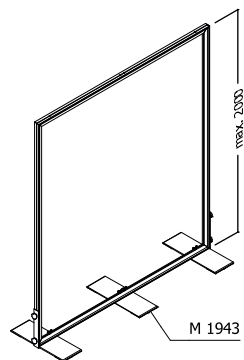
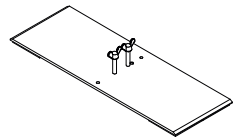

3

FABRIC SUSPENSION SYSTEMS

FABRIC TENSION EXTRUSIONS

BASE PLATE 600 X 250 MM

steel
incl. mounting parts M 1951 BS
for free standing frames made from
extrusions M 1305, M 1307, W 820,
W 825, W 830, W 907
for side mounting and additional
connecting to bottom beam
max. frame height = 2500 mm
7.363 kg

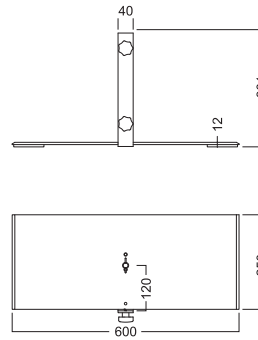

M 1951

M 1951.21

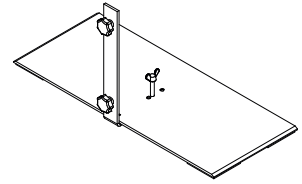

BASE PLATE 600 X 250 MM

steel
incl. mounting parts M 1951 BS
for free standing frames made from
extrusions M 1308
for side mounting and additional
connecting to bottom beam
max. frame height = 2500 mm
8.087 kg

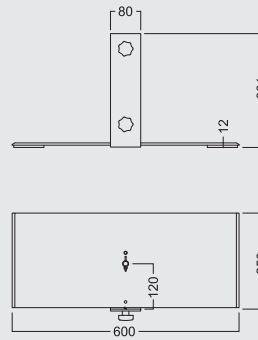
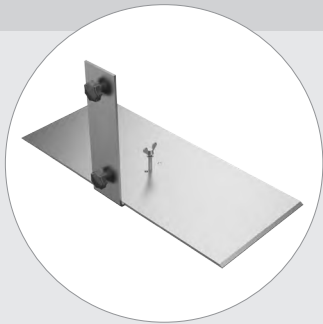

M 1952

M 1952.21

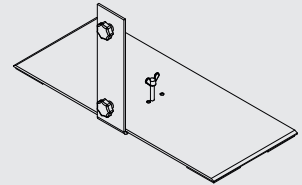

BASE PLATE 600 X 250 MM

steel
incl. mounting parts M 1953 BS
for free standing frames made from
extrusions M 1305, M 1307, M 1308,
W 820, W 825, W 830, W 907
additional center base plate for
connecting to bottom beam
Attention:
for use only with M 1951, M 1952
max. frame height = 2500 mm
6.61 kg

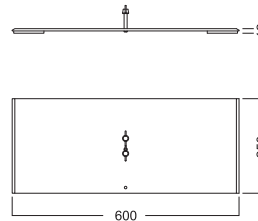

M 1953

M 1953.21

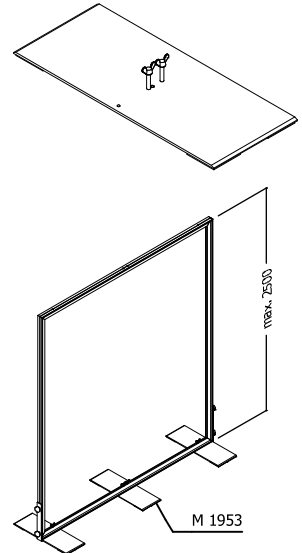

FABRIC SUSPENSION SYSTEMS

FABRIC TENSION EXTRUSIONS

FABRIC TENSION EXTRUSION



aluminium
to fix fabric panels in connection with silicone edge M 1313 for fixing to wooden elements delivery condition unpunched
6000 mm long
1.63 kg

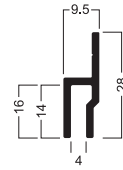

M 1614

M 1614.00

FABRIC SUSPENSION EXTRUSION



aluminium
to fix fabric panels in connection with silicone edge M 1313
6000 mm
2.157 kg

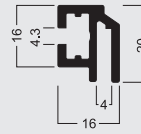

M 1601

M 1601.01

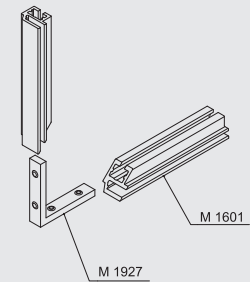

3

HOLDER

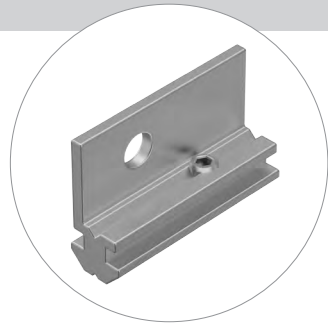

aluminium
incl. set screw M4
for mounting frame made of M 1601 to wall
0.07 kg

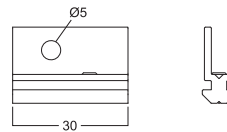

M 1624

M 1624.00

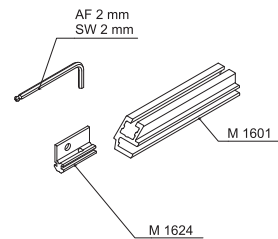

STEEL PLATE

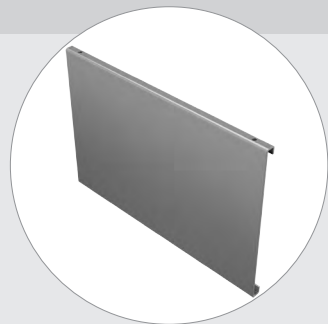

steel, 2 mm thick
for mounting to frame made of M 1601 with beams Z 308 (32 x 16 mm)
1.096 kg

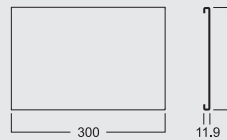

M 1655

M 1655.37

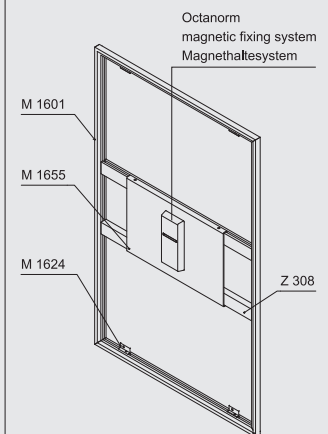

FABRIC SUSPENSION SYSTEMS

FABRIC TENSION EXTRUSIONS

INTERNAL CORNER CONNECTOR

steel
incl. 4 set screws S 4330/20 (M5)
for connection of extrusion M 1601
and extrusion M 1920 for stabilization of
miter
0.014 kg

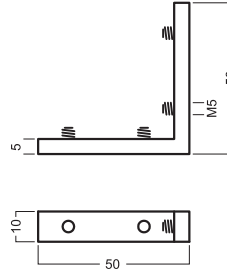

M 1927

M 1927.00

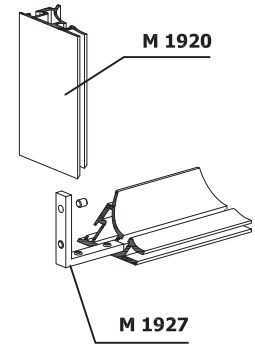

FABRIC TENSION EXTRUSION

aluminium
to fix fabric panels in connection with
silicone edge M 1313
for small formats up to DIN A1
6000 mm long
2.06 kg

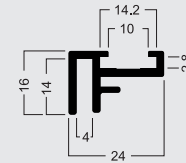

M 1607

M 1607.01

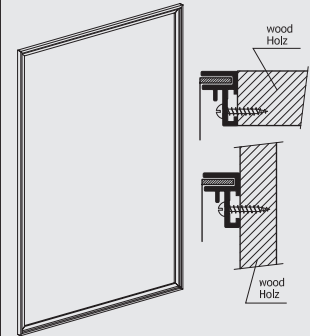

INTERNAL CORNER CONNECTOR

steel
incl. 2 set screws M 1852/20 (M5)
for connection of extrusion M 1607
0.017 kg

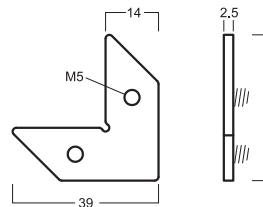

M 1619

M 1619.37

panel for reinforcement
Platte zur Aussteifung

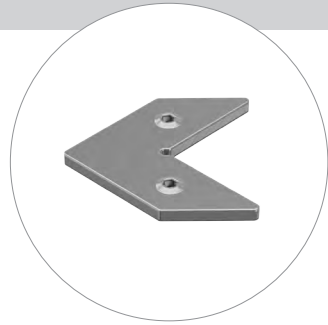
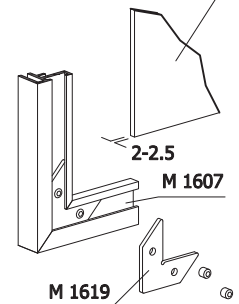

FABRIC TENSION EXTRUSION

aluminium
to fix fabric panels in connection with
silicone edge M 1313
for wall fixing
for small formats up to
841 x 1189 mm
6000 mm long
2.533 kg

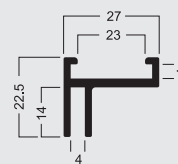

M 1309

M 1309.01

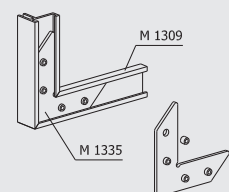

FABRIC SUSPENSION SYSTEMS

FABRIC TENSION EXTRUSIONS

HOLDER

steel
incl. 1 set screw M 1431/20 (M4)
for extrusion M 1309
0.022 kg

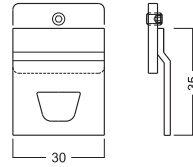

M 1434

M 1434.37

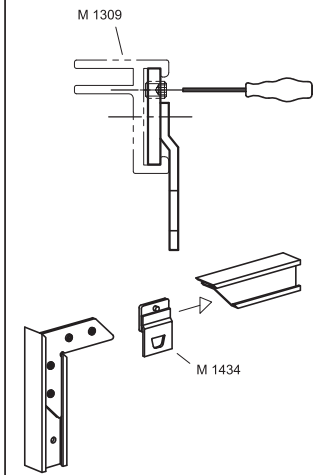

FABRIC TENSION EXTRUSION

aluminium
to fix fabric panels in connection with
silicone edge M 1313
6000 mm long
3.491 kg

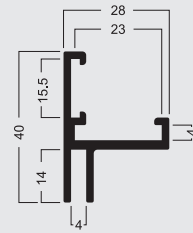

M 1302

M 1302.01

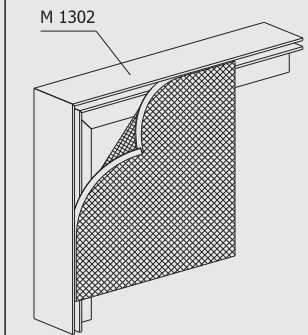

HOLDER

steel
incl. 1 set screw M 1431/20 (M4)
for extrusion M 1302
0.027 kg

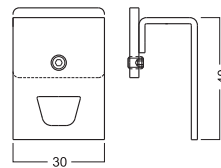

M 1433

M 1433.37

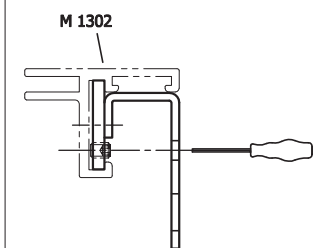

FABRIC SUSPENSION SYSTEMS

FABRIC TENSION EXTRUSIONS

INTERNAL CORNER CONNECTOR

steel
for connection of extrusions M 1302,
M 1309 and S 1605
0.06 kg

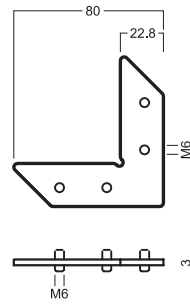

M 1335

M 1335.37

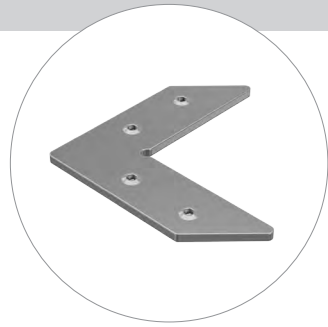
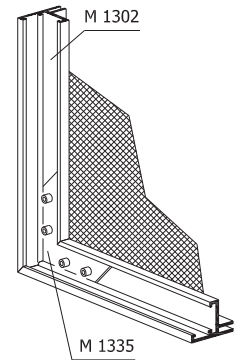

U-CHANNEL EXTRUSION

aluminium
for stabilization of extrusion M 1302
6000 mm long
1.56 kg

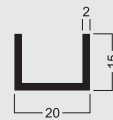

M 1312

M 1312.00

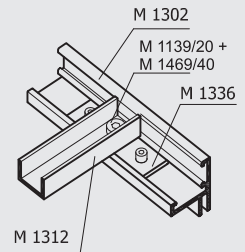

CONNECTOR PLATE

steel
with 2 set screws M 1334/20, 1 round head
screw with flange M 1139/20 (M6) and
1 washer M 1469/40
for mounting to extrusion M 1302
0.003 kg

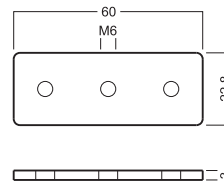

M 1336

M 1336.37

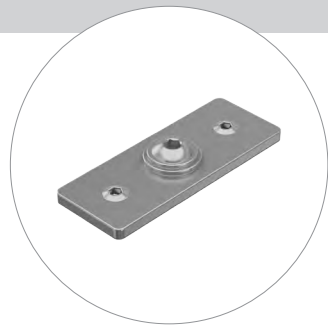
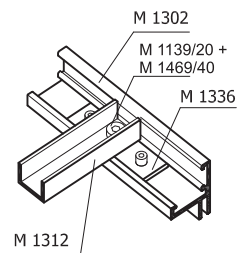

FABRIC SUSPENSION SYSTEMS

FABRIC TENSION EXTRUSIONS

CONNECTING PLATE

steel
incl. 5 round head screws with flange M 1557/20 (M6)
and 5 hex nuts E 601/M (M6)
for reinforcement of fabric frames made of extrusion M 1302, in conjunction with u-channel extrusion M 1312
0.124 kg

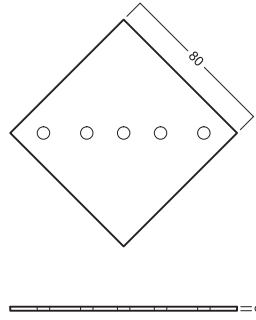
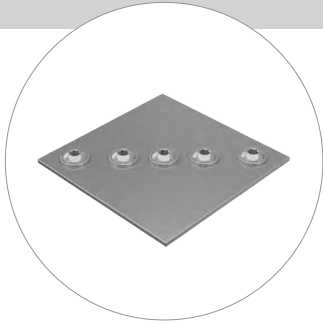

M 1314

M 1314.37

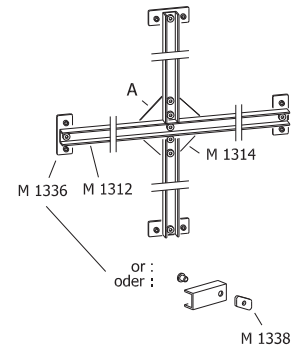
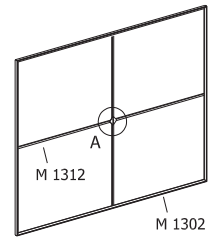

3

THREADED PLATE

steel
female thread M6
can be mounted subsequently in fabric tension extrusion M 1302 for ceiling panel
0.006 kg

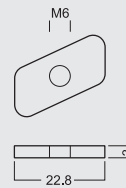

M 1338

M 1338.37

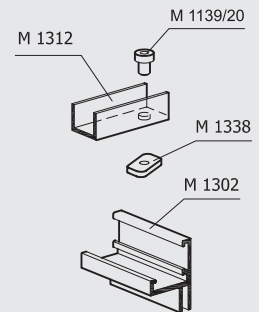

SCREW EYE

steel
can be mounted subsequently to extrusion M 1302
for use with fabric ceilings
0.017 kg

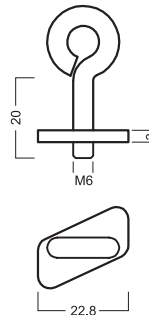

M 1337

M 1337.37

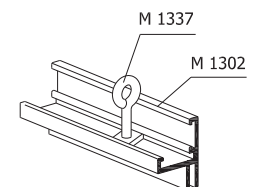

FABRIC SUSPENSION SYSTEMS

FABRIC TENSION EXTRUSIONS

FABRIC TENSION EXTRUSION FOR CUBE ELEMENTS



aluminium
with 2 fabric retaining grooves 90°
to fix fabric panels in connection with
silicone edge M 1313
6000 mm long
5.939 kg

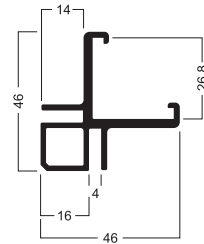

M 1332

M 1332.01

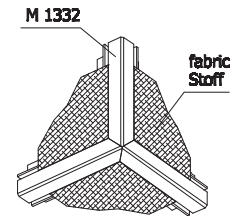

INTERNAL CORNER CONNECTOR

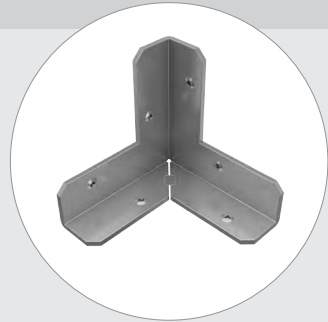

steel
incl. 6 set screws M 1334/20 (M6)
for mounting 3 extrusions M 1332
0.21 kg

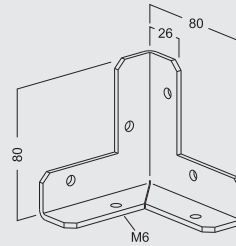

M 1334

M 1334.37

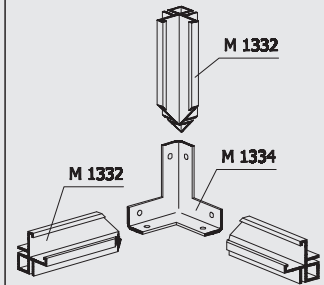
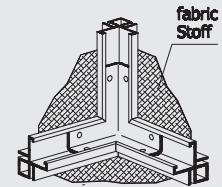

CONNECTION EXTRUSION

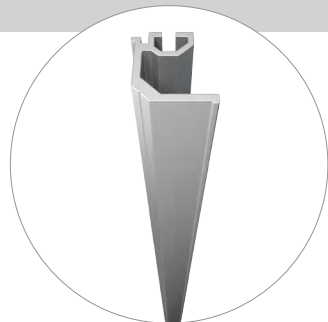

aluminium
can only be slid in extrusion M 1332
before assembly
6000 mm long
3.272 kg

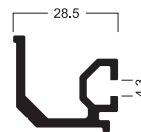

M 1326

M 1326.01

FABRIC EXTRUSIONS FOR LIGHT BOX

FABRIC EXTRUSION FOR LIGHT BOX

aluminium
for light boxes with fabric cover
to fix fabric panels in connection with
silicone edge M 1313
6000 mm long
7.624 kg

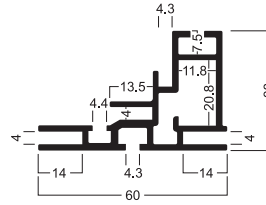
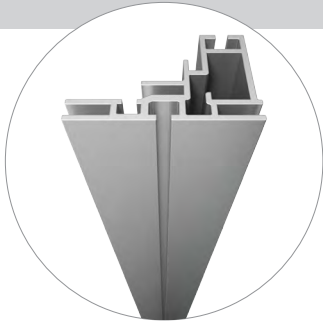

M 1910

M 1910.01

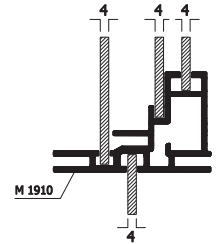
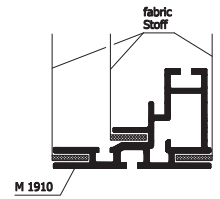
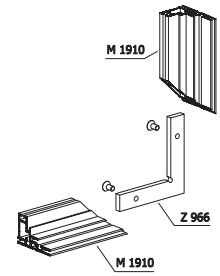

3

FABRIC EXTRUSION FOR LIGHT BOX

aluminium
for light boxes with fabric cover
to fix fabric panels in connection with
silicone edge M 1313
6000 mm long
6.072 kg



M 1920

M 1920.01

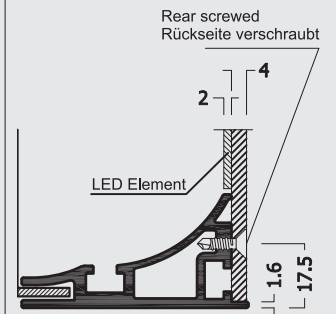

FABRIC SUSPENSION SYSTEMS

FABRIC EXTRUSIONS FOR LIGHT BOX

INTERNAL CORNER CONNECTOR

steel
incl. 4 set screws S 4330/20 (M5)
for connection of extrusion M 1920
0.026 kg

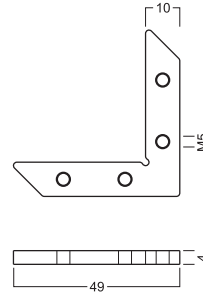

M 1926

M 1926.37

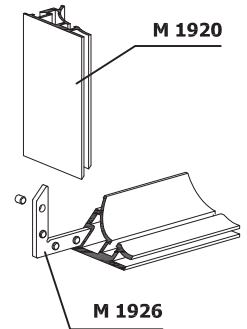

INTERNAL CORNER CONNECTOR

steel
incl. 4 set screws S 4330/20 (M5)
for connection of extrusion M 1601
and extrusion M 1920 for stabilization of miter
0.014 kg

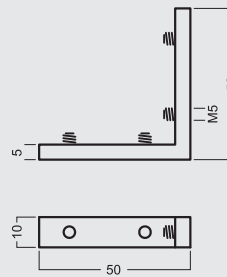

M 1927

M 1927.00

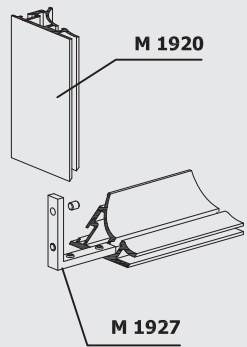

FABRIC EXTRUSION FOR LIGHT BOX

aluminium
for light boxes with fabric cover
to fix fabric panels in connection with
silicone edge M 1313
6000 mm long
11.9 kg

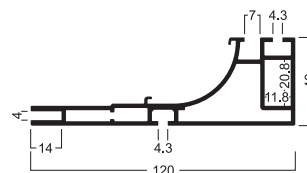

M 1905

M 1905.01

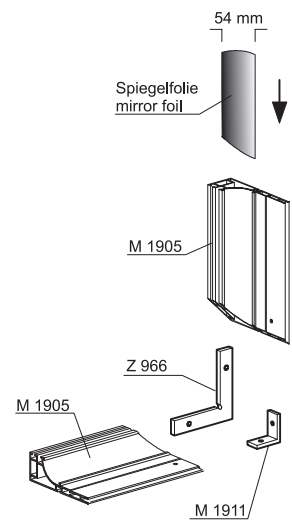

FABRIC SUSPENSION SYSTEMS

FABRIC EXTRUSIONS FOR LIGHT BOX

INTERNAL CORNER CONNECTOR

aluminium
incl. 2 round head screws with flange
M 1911/20 (M5)
for fabric light box extrusion M 1905
0.028 kg

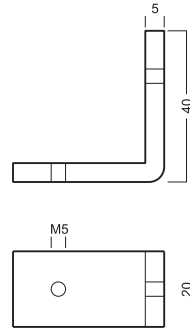
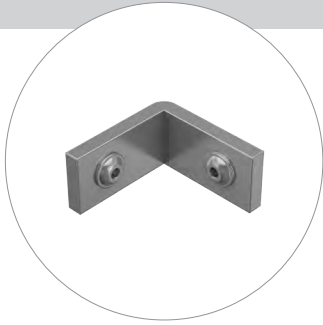

M 1911

M 1911.00

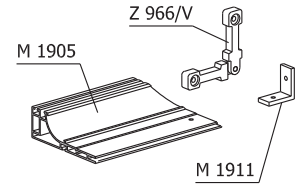

SILICONE EDGE

silicone edge
for fixing of graphics for all fabric tension
extrusions
100 meter roll
5.31 kg

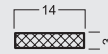

M 1313

M 1313.50

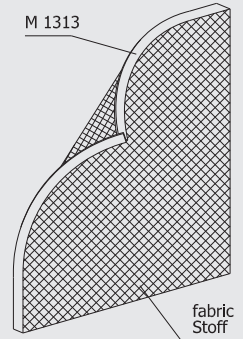

3

FABRIC SUSPENSION SYSTEMS

FABRIC SUSPENSION SYSTEMS

FABRIC CLIP

plastic/spring steel
with tension spring for max. 20 mm tensioning
 for system groove 4.3 mm
 easy mounting (90° rotation)
 0.014 kg

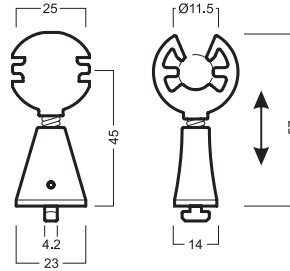

M 1448

M 1448.35

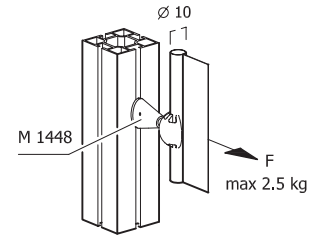

FABRIC CLIP

plastic
without tension spring
 for system groove 4.3 mm
 easy hand mounting (90° rotation)
 0.011 kg

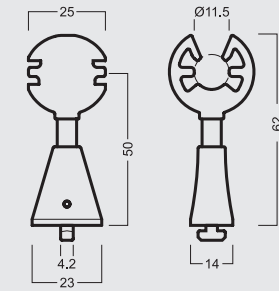

M 1449

M 1449.35

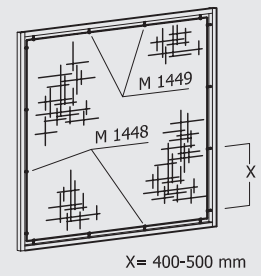

FABRIC CLIP

plastic/spring steel
with tension spring for max. 20 mm tensioning
 for system groove 4.3 mm
 easy mounting (90° rotation)
 0.012 kg

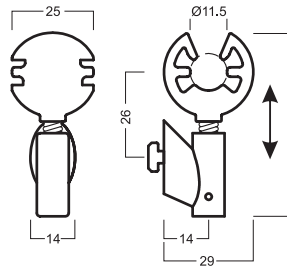

M 1452

M 1452.35

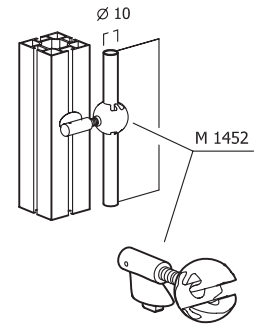

FABRIC SUSPENSION SYSTEMS

FABRIC SUSPENSION SYSTEMS

FABRIC CLIP

plastic
without tension spring
for system groove 4.3 mm
easy mounting (90° rotation)
0.011 kg

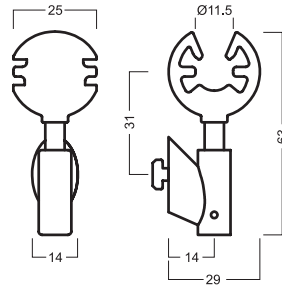

M 1453

M 1453.35

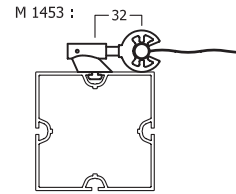

Recommendation for M 1452:
Empfehlung für M 1452:

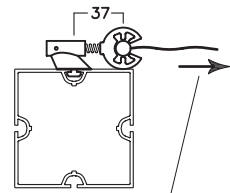

maximum traction force 2.5 kg
max Zugkraft 2.5 kg

3

ROUND TUBE

aluminium
for fabric clip M 1448, M 1449,
M 1452, M 1453
5000 mm long
0.38 kg



M 1458

M 1458.01

Calculation of fabric size
Segelberechnung:

M 1449 :

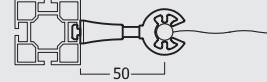

Maximum extension for M 1448:
Spannweg für M 1448 max:

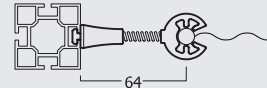

Minimum extension for M 1448:
Spannweg für M 1448 min:

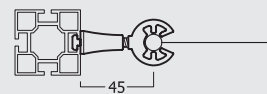

Recommendation for M 1448:
Empfehlung für M 1448:

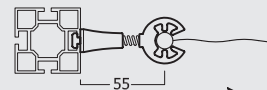

maximum traction force 2.5 kg
max Zugkraft 2.5 kg

END CAP

plastic
for round tube M 1458

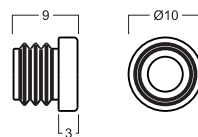

M 1479

M 1479.33

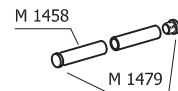

FABRIC SUSPENSION SYSTEMS

FABRIC SUSPENSION SYSTEMS

ROUND TUBE

aluminium
for fabric clip M 1448, M 1449,
M 1452, M 1453
5000 mm long
0.688 kg



M 1468

M 1468.01

END CAP

plastic
for round tube M 1458 and M 1468
0.008 kg

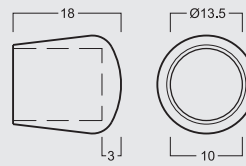

M 1459

M 1459.33

M 1458
M 1468

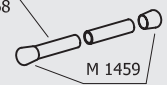

ROLL-DOWN WALL

ROLLER BLIND BEAM

aluminium
incl. 2 tension locks Z 961/8,
spring motor M 841 with spring shaft
retainers,
preceeding foil M 892 and
bottom fastening extrusion
fabric not included
950 mm long
4.956 kg

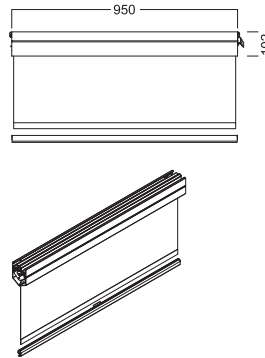
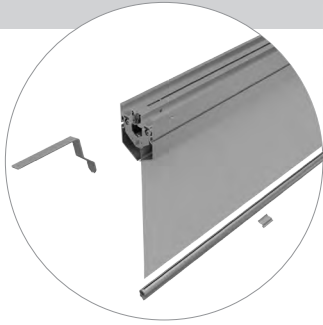

M 811

M 811.01

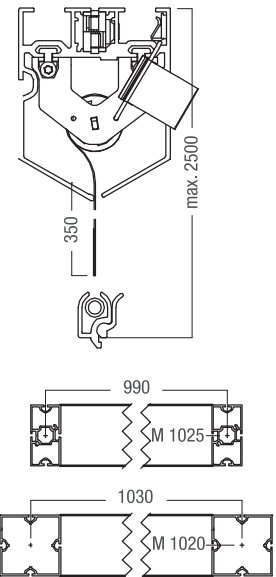

ROLLER BLIND BEAM

aluminum
incl. 2 tension locks Z 961/8,
spring motor M 842 with spring shaft
retainers,
preceeding foil M 892
and bottom fastening extrusion
fabric not included
1940 mm long
9.702 kg

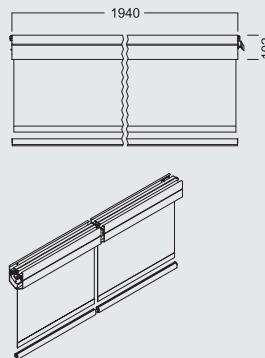
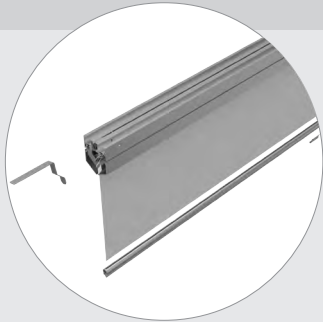

M 816

M 816.01

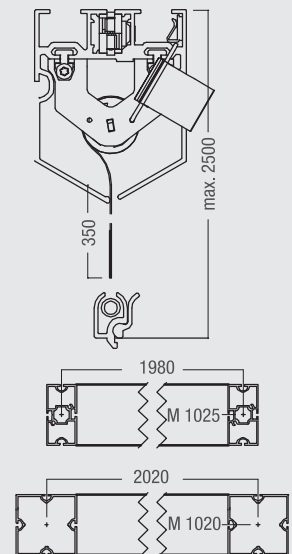

FABRIC SUSPENSION SYSTEMS

BANNER SUSPENSION EXTRUSIONS

FABRIC SUSPENSION EXTRUSION

aluminium
incl. 6 locking clips M 1360/1, 40 mm long for suspension of graphics on 1 side, both sides or in the middle; middle can also be used for 8 mm glass panels or 16 mm wooden panels for suspension of graphics on round tube 8 - 12 mm dia.
5000 mm long
6.77 kg

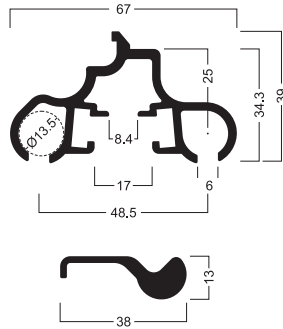

M 1360

M 1360.01

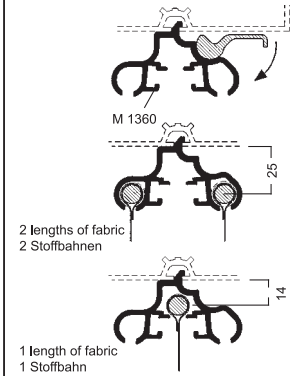

FABRIC SUSPENSION EXTRUSION

aluminium
incl. 6 locking clips M 1358/1 for suspension of graphics on round tube 8 - 12 mm dia.
5000 mm long
2.264 kg

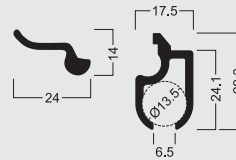

M 1358

M 1358.01

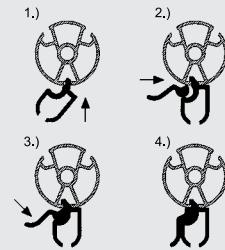

FABRIC SUSPENSION BEAM EXTRUSION 32 MM

aluminium
for digitally printed graphics with round keder
min. 4 mm dia., max. 6 mm dia.
5000 mm long
2.45 kg

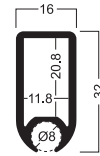

M 1353

M 1353.01

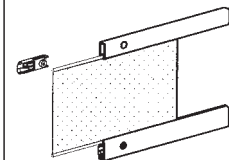

FABRIC SUSPENSION BEAM EXTRUSION 40 MM

aluminium
1 system groove for digitally printed graphics with round keder
min. 4 mm dia., max. 6 mm dia.
5000 mm long
3.18 kg

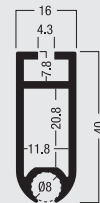

M 1354

M 1354.01

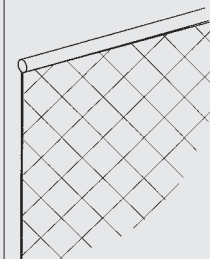

FABRIC SUSPENSION SYSTEMS

BANNER SUSPENSION EXTRUSIONS

FABRIC SUSPENSION BEAM EXTRUSION 40 MM

aluminium
2 system grooves
for digitally printed graphics
with round keder
min. 4 mm dia., max. 6 mm dia.
5000 mm long
3.264 kg

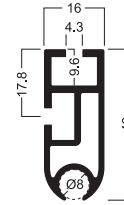

M 1356

M 1356.01

M 1140 + M 1142

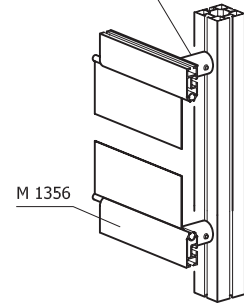

END CAP

plastic
for extrusions M 1354, M 1356
0.003 kg

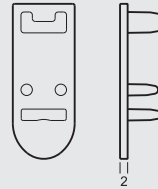

M 1365/K

M 1365/K.35

END CAP WITH KNURLED-HEAD SCREW

plastic
incl. knurled-head screw M3
for extrusions M 1354, M 1356
0.008 kg

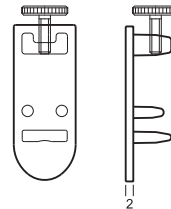

M 1365/KS

M 1365/KS.35

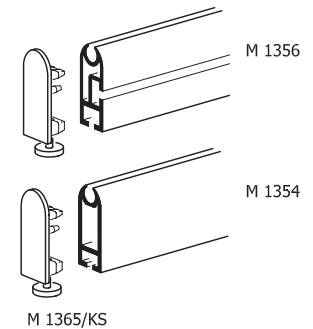

CONNECTOR, STRAIGHT

steel
incl. 4 set screws M 1359/1 (M6)
for extrusion M 1356
0.055 kg

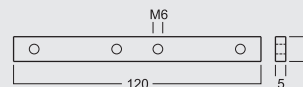

M 1359

M 1359.37

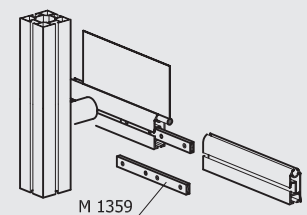

FABRIC SUSPENSION SYSTEMS

BANNER SUSPENSION EXTRUSIONS

FABRIC SUSPENSION EXTRUSION 33.5 MM

aluminium
1 system groove, 2 welt grooves
for use with round keder
min. 4 mm dia., max. 6 mm dia.
5000 mm long
2.581 kg

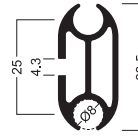

M 1324

M 1324.01

M 1140 + M 1142

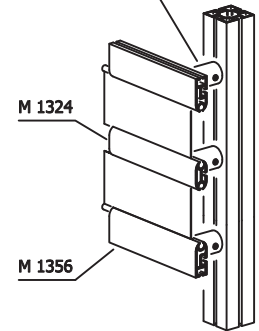

FABRIC SUSPENSION EXTRUSION

aluminium
for digitally printed fabric panels
for use with round keder
min. 4 mm, max. 6 mm
5000 mm long
1.159 kg

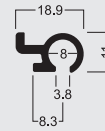

M 1361

M 1361.01

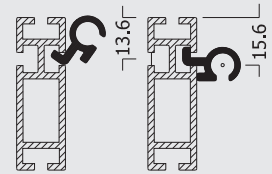

FABRIC SUSPENSION EXTRUSION

aluminium
for digitally printed fabric panels
for use with round keder
min. 4 mm, max. 6 mm
5000 mm long
2.378 kg



M 1363

M 1363.01

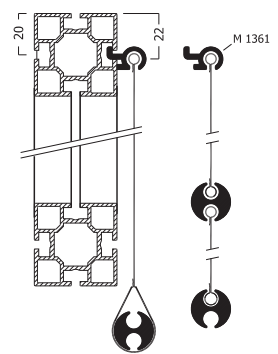

FABRIC SUSPENSION SYSTEMS

MAGNET RETAINER SYSTEMS

MAGNETIC WALL RETAINER

plastic/slate grey RAL 7015 with receiving slot for hook-in systems, with **15** round magnets on the back for quick positioning on wall elements with fabric covered steel panels, non-slipping guaranteed for up to **5 kg** distributed load
PLEASE NOTE: Only hook-in systems with a maximum projection of 200 mm are admitted!
 (Except MF 233 S)
 0.235 kg

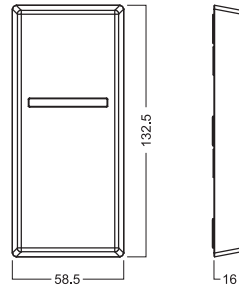

MF 15

MF 15.90

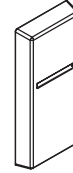

MAGNETIC WALL RETAINER

plastic/slate grey RAL 7015 with receiving slot for hook-in systems, with **12** round magnets on the back for quick positioning on wall elements with fabric covered steel panels, non-slipping guaranteed for up to **3 kg** distributed load
PLEASE NOTE: Only hook-in systems with a maximum projection of 200 mm are admitted!
 (except MF 233 S)
 0.2 kg

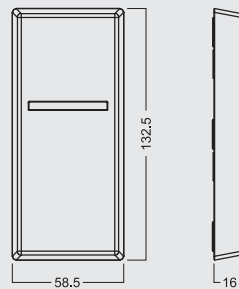

MF 12

MF 12.90



MAGNETIC WALL RETAINER

plastic/slate grey RAL 7015 with receiving slot for hook-in systems, with **4** round magnets on the back for quick positioning on wall elements with fabric covered steel panels, non-slipping guaranteed for up to **0.5 kg** distributed load
PLEASE NOTE: Only hook-in systems with a maximum projection of 100 mm are admitted!
 0.123 kg

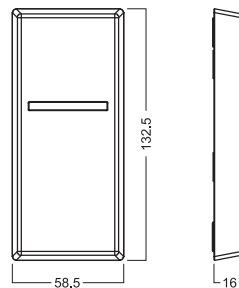

MF 4

MF 4.90

MAGNET SINGLE DISPENSER ARM "LIGHT"

steel, chrome plated with **2** rectangular magnets on the back for quick positioning on wall elements with fabric covered steel panels non-slipping guaranteed for up to **0.5 kg** distributed load
 projection 80 mm
 0.05 kg

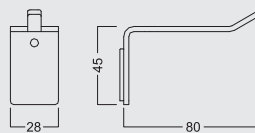

MF 21

MF 21.41

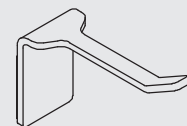

3

FABRIC SUSPENSION SYSTEMS

MAGNET RETAINER SYSTEMS

HANGING ARM / SLOPING

steel, chrome plated
for hooking into wall retainer MF 12, MF 15
with 5 balls
projection 130 mm
0.19 kg

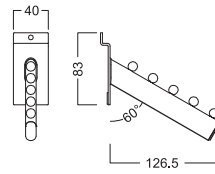

MF 202 S

MF 202 S.41

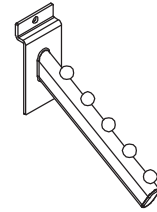

HANGING ARM / STRAIGHT

steel, chrome plated
for hooking into wall retainer MF 12, MF 15
projection 202 mm
0.22 kg

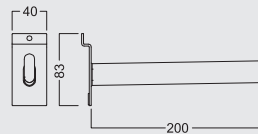

MF 204 S

MF 204 S.41

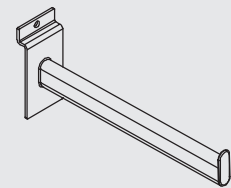

SINGLE DISPENSER ARM

steel, chrome plated
for hooking into wall retainer MF 12, MF 15
projection 100 mm
0.09 kg

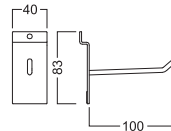

MF 207 S

MF 207 S.41

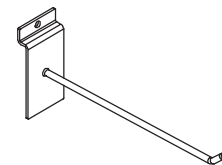

SINGLE DISPENSER ARM

steel, chrome plated
for hooking into wall retainer MF 12, MF 15
projection 200 mm
0.13 kg

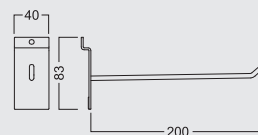

MF 209 S

MF 209 S.41

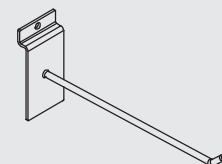

LOOPED DISPENSER ARM

steel, chrome plated
for hooking into wall retainer MF 12, MF 15
projection 200 mm
0.126 kg

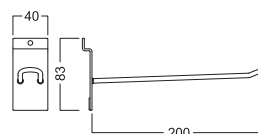

MF 226 S

MF 226 S.41

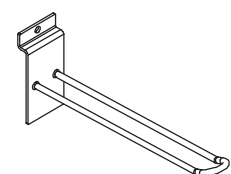

FABRIC SUSPENSION SYSTEMS

MAGNET RETAINER SYSTEMS

DISPLAY RING

steel, chrome plated
for hooking into wall retainer MF 12, MF 15
projection 250 mm
0.19 kg

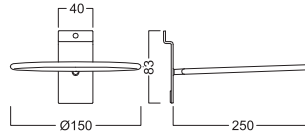

MF 233 S

MF 233 S.41

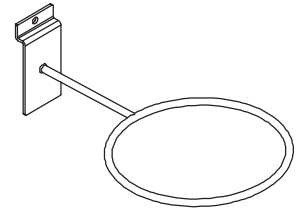

BRACKET / STRAIGHT

steel, chrome plated
for hooking into wall retainer MF 12, MF 15
for 8 mm glass and wooden shelves
for maximum projection of 200 mm
0.22 kg

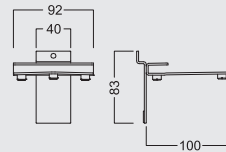

MF 306 S

MF 306 S.41

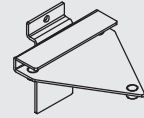

3

GLASS SHELF

acrylic glass, clear 8 mm
for bracket MF 306 S
size: 125 x 250 mm
0.3 kg

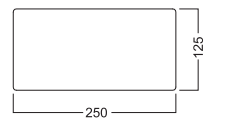

MF 125 G

MF 125 G.51

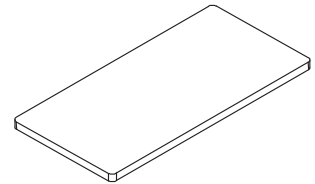

GLASS SHELF

acrylic glass, clear 8 mm
for bracket MF 306 S
size: 150 x 300 mm
0.42 kg

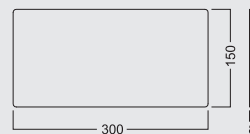

MF 150 G

MF 150 G.51

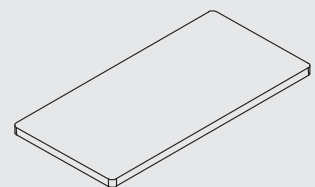

WOOD SHELF

wood, white, 8 mm
for bracket MF 306 S
size: 125 x 250 mm
0.232 kg

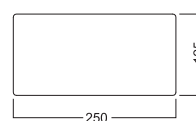

MF 125 P

MF 125 P.30

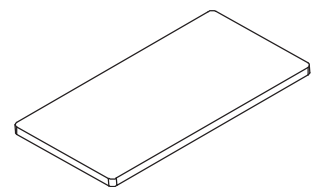

FABRIC SUSPENSION SYSTEMS

MAGNET RETAINER SYSTEMS

WOOD SHELF

wood, white, 8 mm
for bracket MF 306 S
size: 150 x 300 mm
0.335 kg

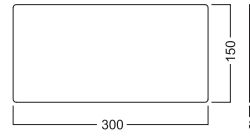

MF 150 P

MF 150 P.30

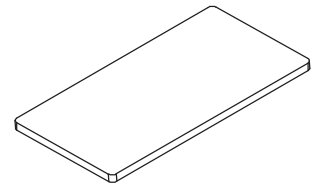

BROCHURE SHELF

acrylic glass transparent
for hooking into wall retainer MF 4, MF 12,
MF 15
DIN long
0.211 kg

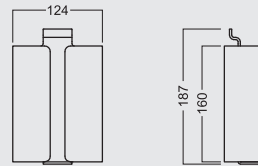
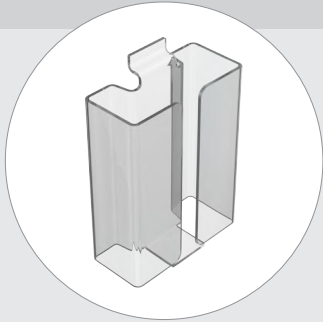

MF 60

MF 60.51

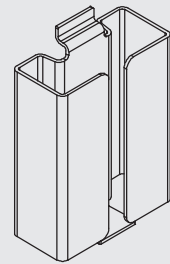

BROCHURE SHELF

acrylic glass transparent
for hooking into wall retainer MF 4, MF 12,
MF 15
DIN A4
0.528 kg

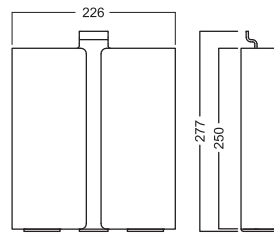
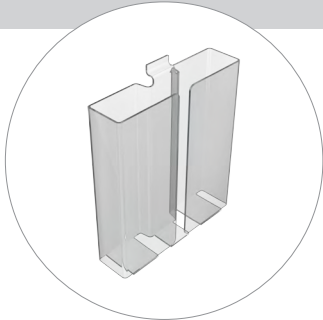

MF 64

MF 64.51

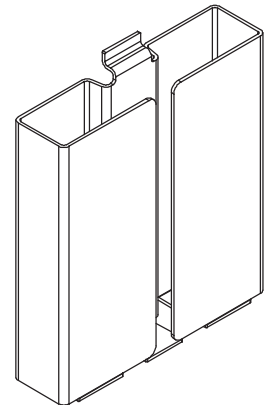

ASSEMBLY HANDLE

steel, rubber
for easier assembly of wall retainer
MF 4, MF 12, MF 15
0.21 kg

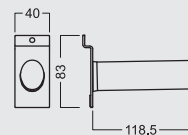

MF 1

MF 1.90

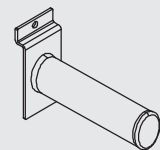

FABRIC SUSPENSION SYSTEMS

MAGNET RETAINER SYSTEMS

STEEL PLATE

steel, 2 mm thick
for mounting to wall elements with
beams Z 308 (32 x 16 mm)
300 mm long
1.182 kg

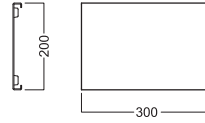

MF 80

MF 80.37

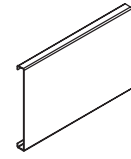

STEEL PLATE

steel, 2 mm thick
for mounting to wall elements with
beams Z 308 (32 x 16 mm)
719 mm long
2.823 kg

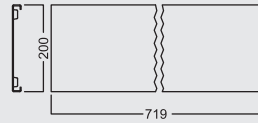

MF 82

MF 82.37

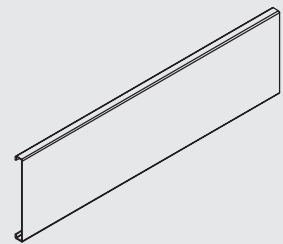

3

STEEL PLATE WITH 2 BEAMS

steel/aluminium
with 2 beams Z 308 (32 x 16 mm) for
OCTAfabric set M-Set 1307
300 mm long
1.182 kg

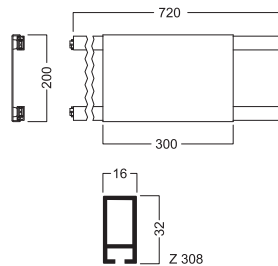

MF 100

MF 100.90

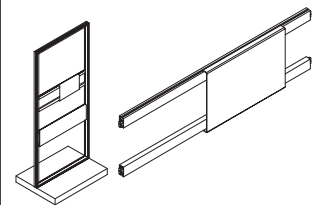

STEEL PLATE WITH 2 BEAMS

steel/aluminium
with 2 beams Z 308 (32 x 16 mm) for
OCTAfabric set M-Set 1307
719 mm long
3.763 kg

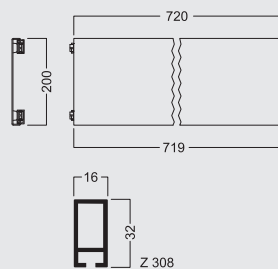

MF 105

MF 105.90

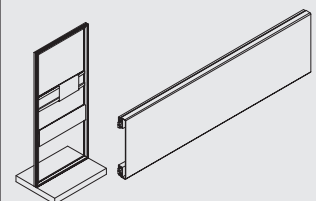



Panel Clad Wall

174

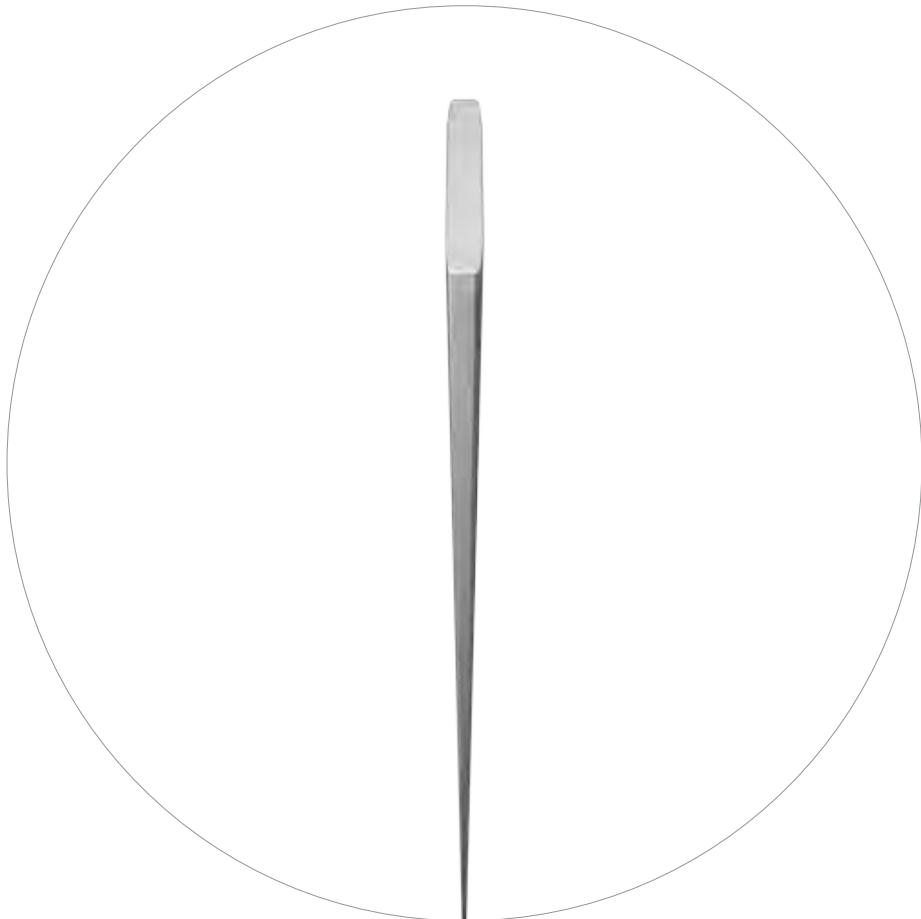

Accessories

177



4

Wall Panel Retainer

178

PANEL CLAD WALL

PANEL CLAD WALL

BEAM EXTRUSION 70 MM

aluminium
with supporting flange for 16 mm wall
cladding on one side
tension lock Z 961/13 can be mounted
5000 mm long
6.51 kg

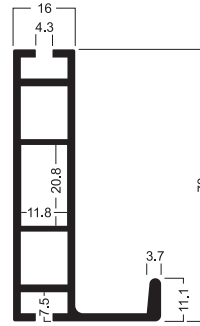
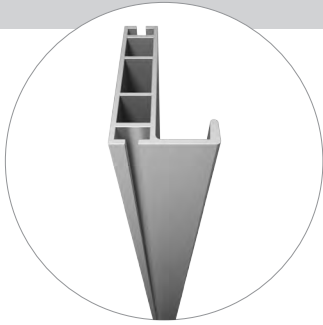

W 103

W 103.11

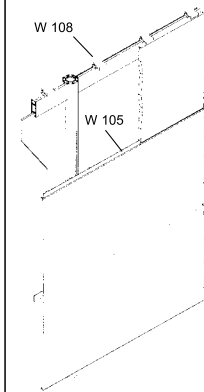

BEAM EXTRUSION 50 MM

aluminium
with supporting flange for 16 mm wall
cladding on one side
tension lock Z 961/13 can be mounted
5000 mm long
5.56 kg

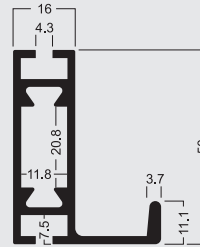

W 101

W 101.11

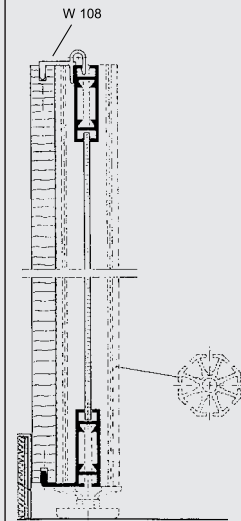

BEAM 50 MM

aluminium
miter cut for internal corners
incl. 2 built-in tension locks Z 961/13
455 mm long
0.66 kg

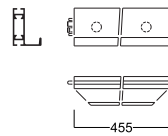

W 115/G

W 115/G.11

PANEL CLAD WALL

PANEL CLAD WALL

BEAM 50 MM

aluminium
 miter cut for internal corners
 incl. 2 built-in tension locks Z 961/13
660 mm long
 0.938 kg

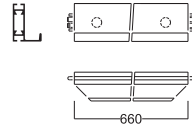

W 116/G

W 116/G.11

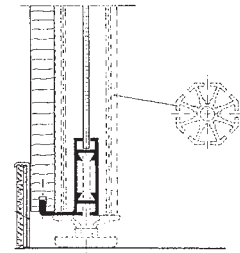

BEAM 50 MM

aluminium
 miter cut for internal corners
 incl. 2 built-in tension locks Z 961/13
950 mm long
 1.216 kg

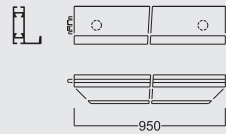

W 117/G

W 117/G.11

4

BEAM 50 MM

aluminium
 miter cut for internal corners
 incl. 2 built-in tension locks Z 961/13
1360 mm long
 1.994 kg

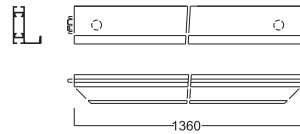

W 118/G

W 118/G.11

BEAM EXTRUSION 50 MM

aluminium
 with supporting flange for 16 mm wall
 cladding on both sides
 tension lock Z 961/13 can be mounted
 5000 mm long
 6.59 kg

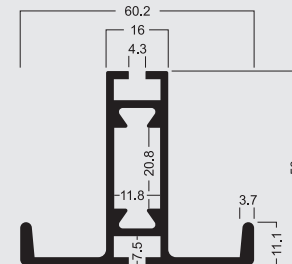
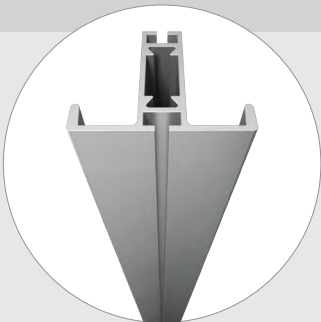

W 102

W 102.11

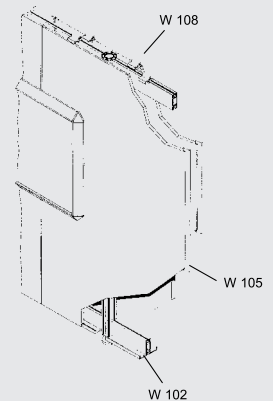

PANEL CLAD WALL

PANEL CLAD WALL

BEAM 50 MM

aluminium
 miter cut for internal corners
 incl. 2 built-in tension locks Z 961/13
455 mm long
 0.763 kg

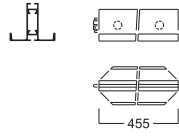

W 125/G

W 125/G.11

BEAM 50 MM

aluminium
 miter cut for internal corners
 incl. 2 built-in tension locks Z 961/13
660 mm long
 1.046 kg

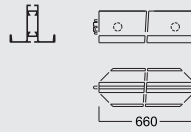

W 126/G

W 126/G.11

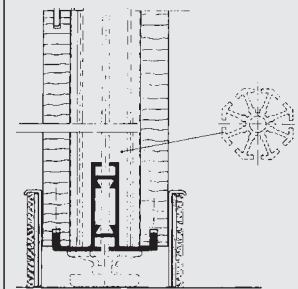

BEAM 50 MM

aluminium
 miter cut for internal corners
 incl. 2 built-in tension locks Z 961/13
950 mm long
 1.422 kg

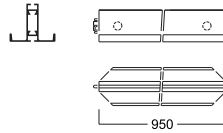

W 127/G

W 127/G.11

ACCESSORIES

CONNECTING SPLINE

aluminium
with 6 holes, (2 mm dia.) on one edge
5000 mm long
1.199 kg

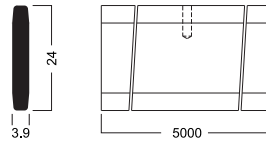

W 105

W 105.01

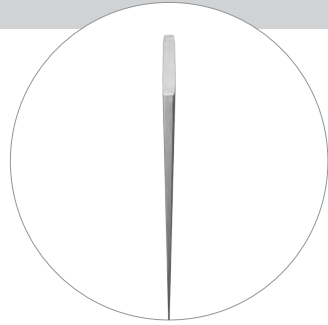
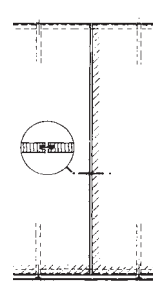

PANEL RETAINER, ON TOP

aluminium
with clip-on mechanism for beams on top
0.013 kg

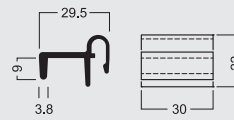

W 108

W 108.00

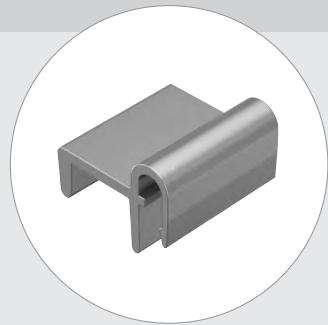
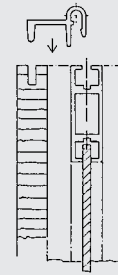

PANEL RETAINER

aluminium
to be fixed to system groove of the upright
from outside (90°) in conjunction with
W 105 for horizontal concealed joint
30 mm long
0.009 kg

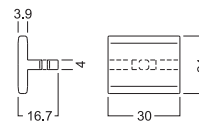

W 109

W 109.00

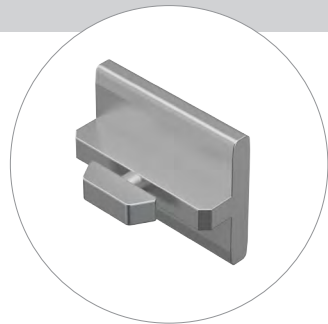
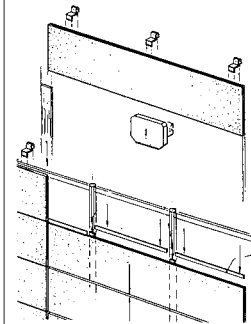

PANEL CLAD WALL

WALL PANEL
RETAINER

WALL PANEL RETAINER "TOP"

aluminium
for **single sided** panel clad wall
in conjunction with **40 mm** square
extrusions
5000 mm long
1.478 kg

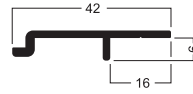

M 1561

M 1561.00

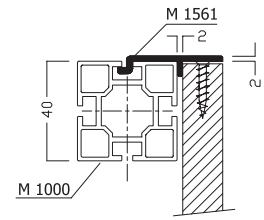

WALL PANEL RETAINER "TOP"

aluminium
for **double sided** panel clad wall
in conjunction with **40 mm** square
extrusions
5000 mm long
1.37 kg

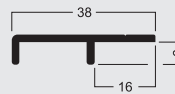

M 1562

M 1562.00

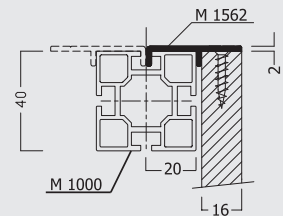

WALL PANEL RETAINER "TOP"

aluminium
for **single sided** panel clad wall
in conjunction with **40 mm** square
extrusions
5000 mm long
2.09 kg

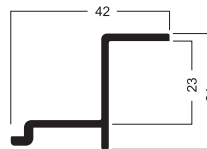

M 1563

M 1563.00

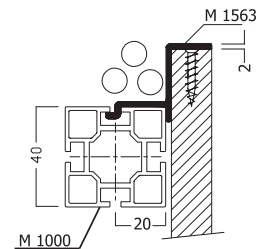

WALL PANEL
RETAINER "CENTRE"

aluminium
for **double sided** panel clad wall
in conjunction with **40 mm** square
extrusions
5000 mm long
2.04 kg

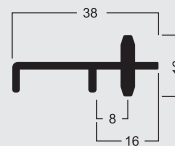

M 1567

M 1567.00

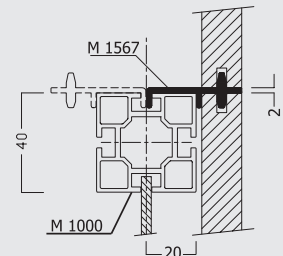

PANEL CLAD WALL

WALL PANEL
RETAINER

WALL PANEL
RETAINER "CENTRE"

aluminium
for **single sided** panel clad wall
in conjunction with **40 mm** square
extrusions
5000 mm long
2.28 kg

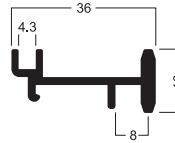

M 1568

M 1568.00

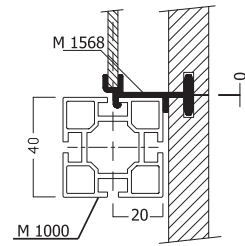

WALL PANEL
RETAINER "BOTTOM"

aluminium
for **single or double sided** panel clad wall
in conjunction with **40 mm** square
extrusions
5000 mm long
1.619 kg

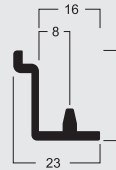

M 1571

M 1571.00

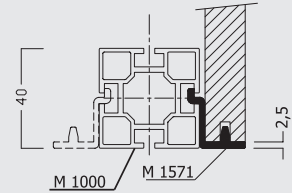

4

WALL PANEL RETAINER "TOP"

aluminium
for **single or double sided** panel clad wall
in conjunction with **80 mm** square
extrusions
5000 mm long
1.903 kg

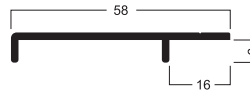

M 1572

M 1572.00

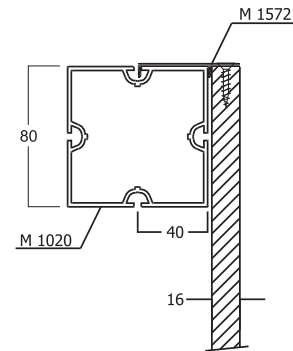

PANEL CLAD WALL

WALL PANEL
RETAINER

WALL PANEL
RETAINER "CENTRE"

aluminium
for **single or double sided** panel clad wall
in conjunction with **80 mm** square
extrusions
5000 mm long
2.586 kg

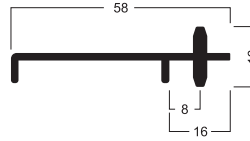

M 1577

M 1577.00

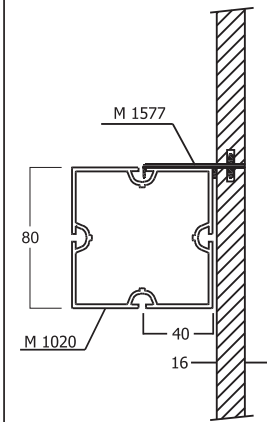

WALL PANEL
RETAINER "BOTTOM"

aluminium
for **single or double sided** panel clad wall
in conjunction with **80 mm** square
extrusions
5000 mm long
2.166 kg



M 1581

M 1581.00

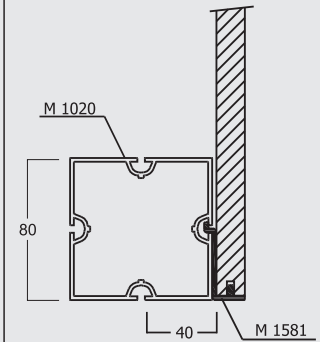

PANEL RETAINER

aluminium
to be fixed to 40 mm extrusions
(M 1000, S 108 ...)
0.015 kg

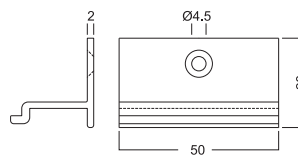

M 1575

M 1575.00

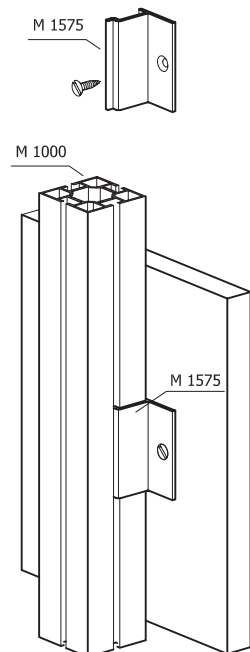

WALL PANEL
RETAINER

FIXING ANGLE

steel
for 80 mm and 120 mm square extrusions
without mounting parts
0.207 kg

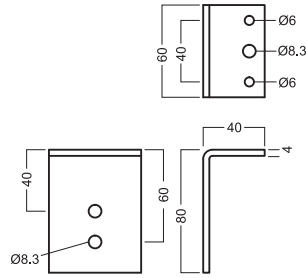
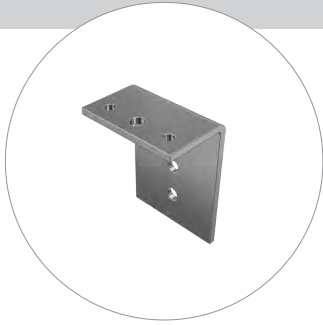

M 1117

M 1117.37

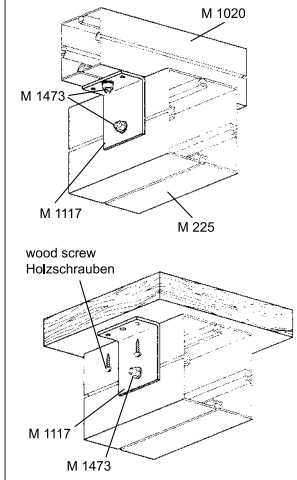

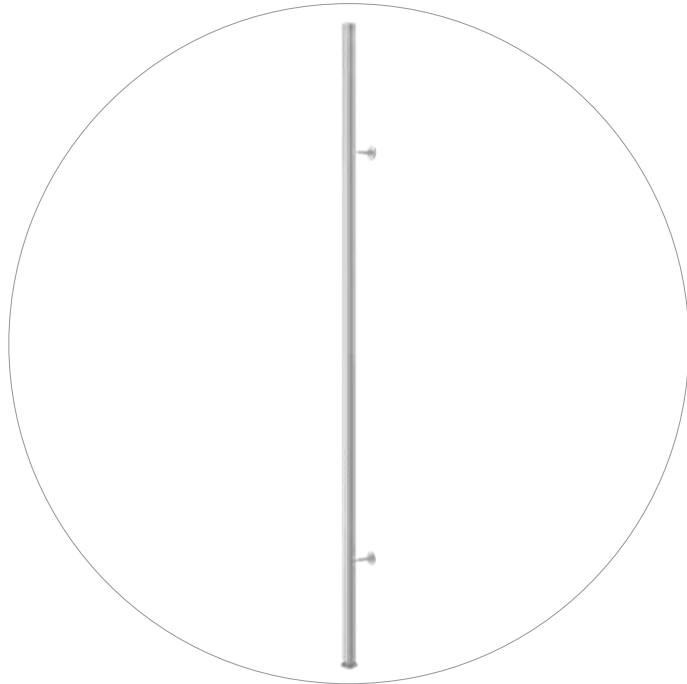

OCTAframe | Extrusions and Accessories
184

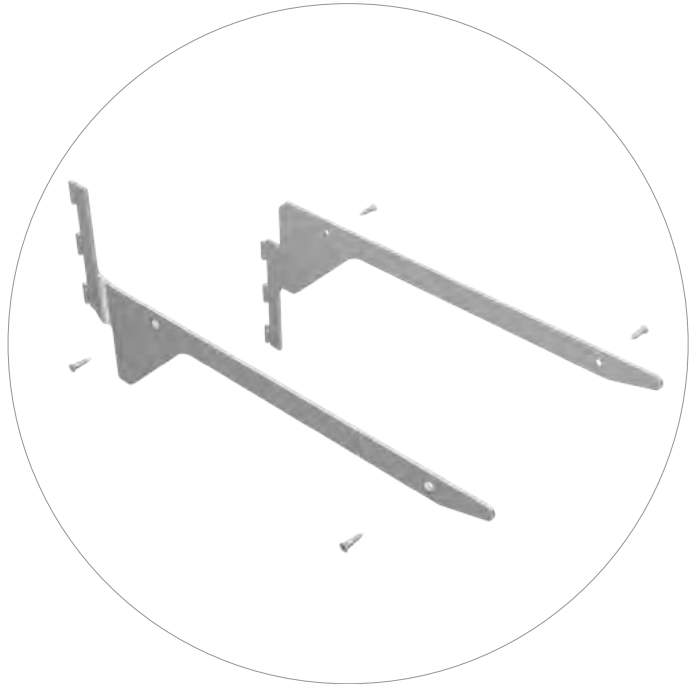

OCTAframe | Shelf brackets
185

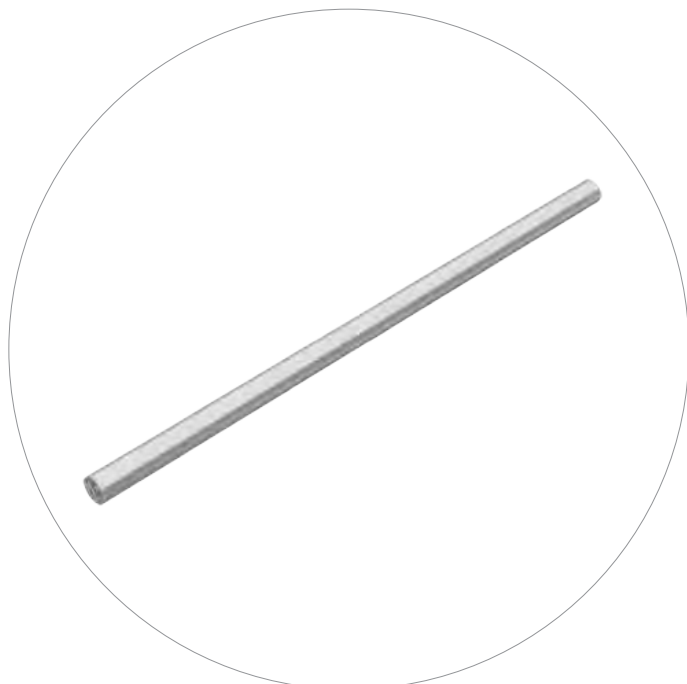

OCTAframe | Clothes Rails
188

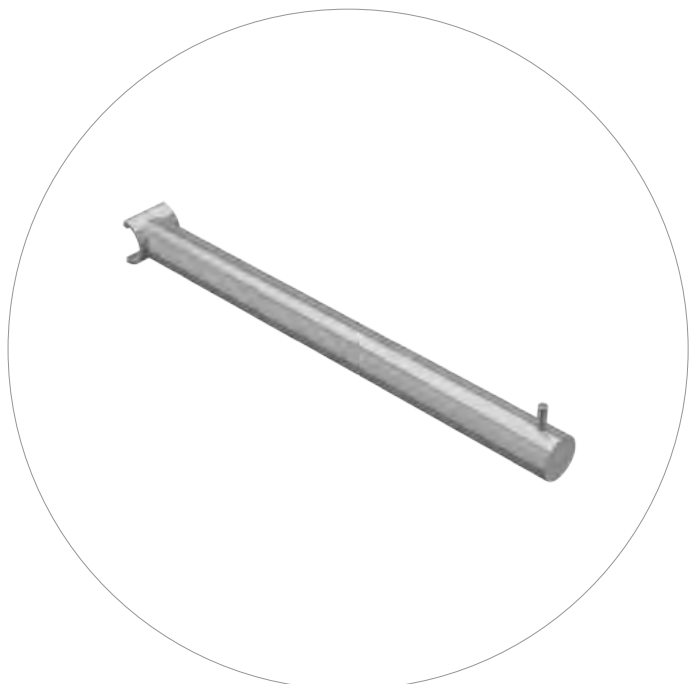

OCTAframe | Hanging arms
190

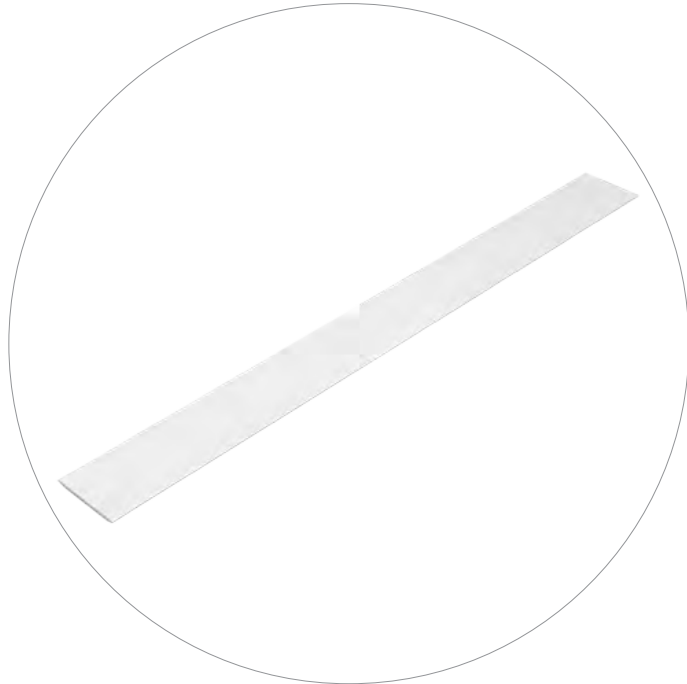

OCTAframe | Wooden shelves
191



Elliptical Extrusions
193

5

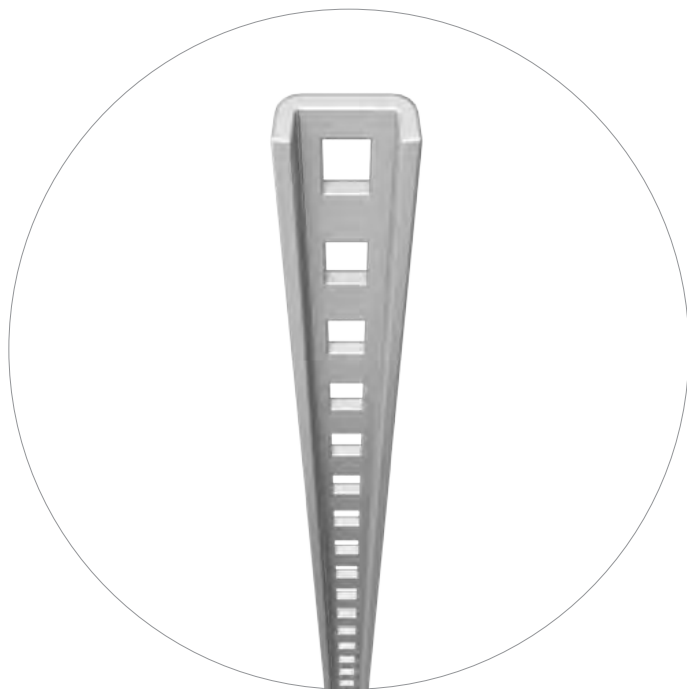

Elliptical Extrusions | Slotted insert rails
194

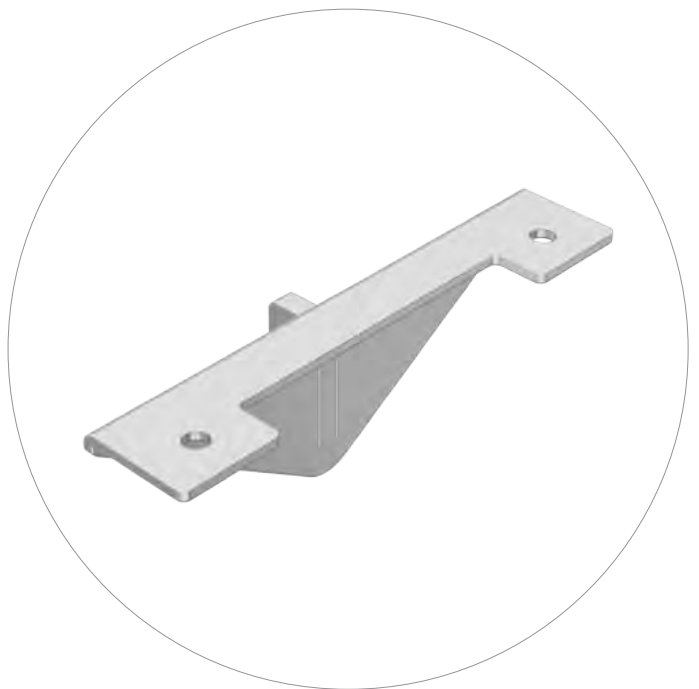

Elliptical Extrusions | Shelf brackets
194

OCTAFRAME

UPRIGHT

aluminium/steel
extrusion M 1000-25 P1 for front version
with slotted accessory groove on one side
incl. adjustable foot M 1039 and 2 spacers
P 488
2505 mm long
3.684 kg

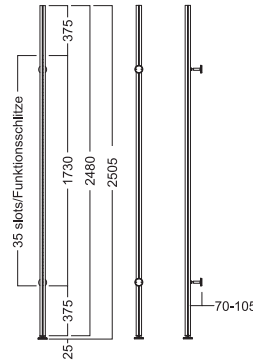
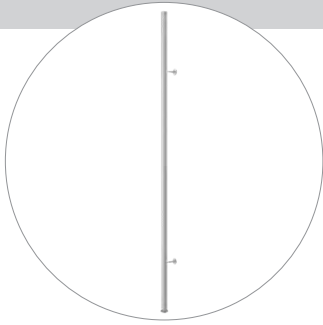

M 1000-25 S1

**EXTRUSIONS AND
ACCESSORIES**

M 1000-25 S1.01

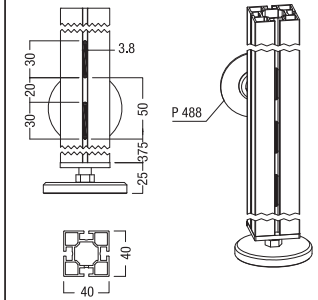

CUT TO LENGTH EXTRUSION

aluminium
extrusion M 1000 cut-to-length for front
version
with slotted accessory groove on one side
2480 mm long
3.25 kg

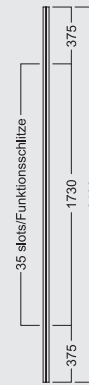
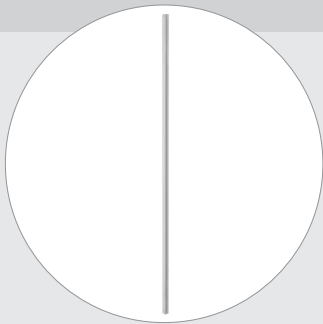

M 1000-25 P1

M 1000-25 P1.01

END PLATE

die cast
for all square extrusions 40 mm
0.033 kg

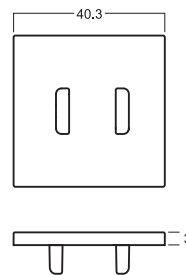
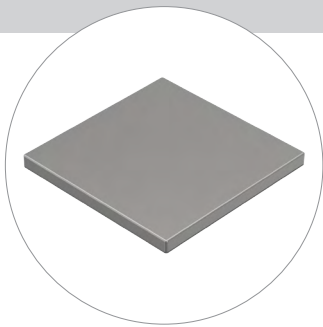

M 1015

M 1015.21

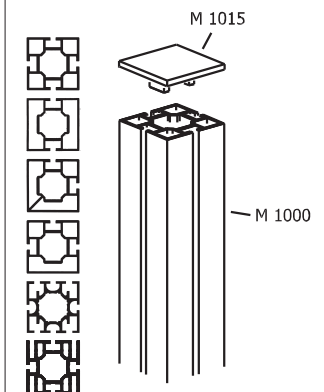

OCTAFRAME

DISTANCE PIECE

steel
with 1 hammerhead screw M10
for wall fixing with covering plate
adjustable from 70 to 105 mm
0.166 kg

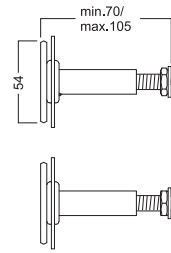

P 488

P 488.90

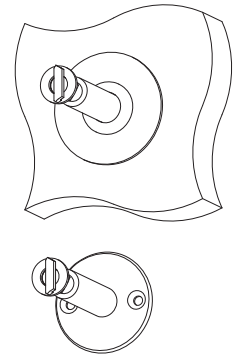

DISTANCE PIECE

steel
with 1 hammerhead screw M10
for system groove 4.3 mm
adjustable from 66 to 101 mm
0.06 kg

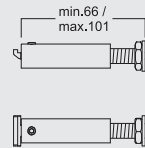

P 478

P 478.90

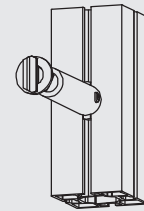

SHELF BRACKETS, STRAIGHT

steel
left- and right-hand
incl. 4 countersunk screws P 700/20
for postformed shelf P 950 / 400 mm
front hanging (single row of slots)
max. uniformly distributed load = 40 kg
1.1 kg

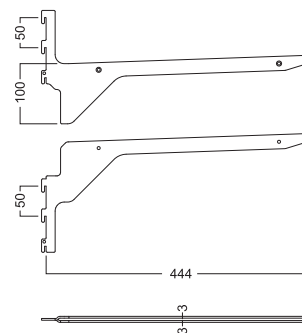

P 700

SHELF BRACKETS

P 700.21

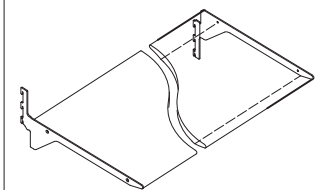

OCTAFRAME

SHELF BRACKET, ADJUSTABLE

steel
left and right
incl. 4 countersunk screws P 700/20
for postformed shelf P 950/ 400 mm
front hanging (single row of slots)
1 kg

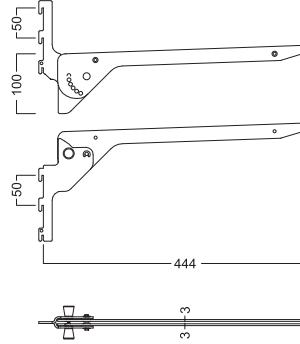
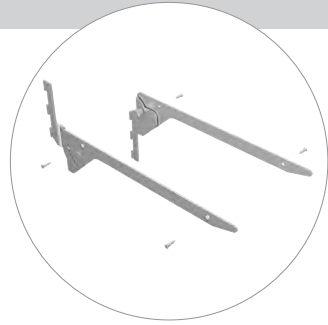

P 705

SHELF BRACKETS

P 705.21

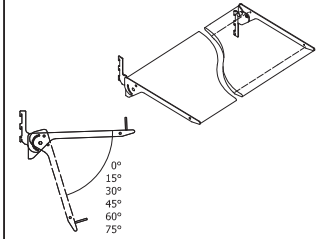

SHELF BRACKETS, STRAIGHT

steel
left- and right-hand
incl. 4 countersunk screws P 700/20
for postformed shelf P 950 / 400 mm
and clothes rail P 880-P 890
front hanging (single row of slots)
max. uniformly distributed load = 35 kg
1.2 kg

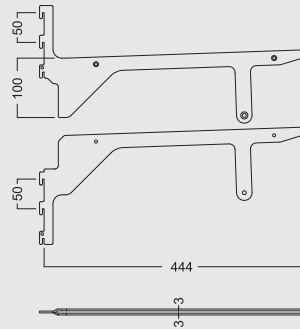
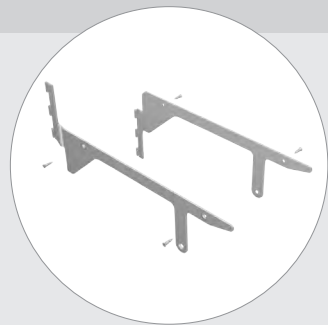

P 710

P 710.21

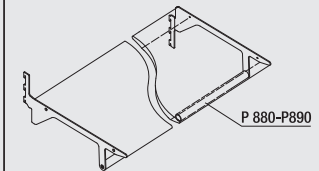

SHELF BRACKETS, STRAIGHT

steel
left- and right-hand
incl. 8 countersunk screws P 700/2
for postformed shelf P 950 / 400 mm
or wooden shelf
front hanging (single row of slots)
max. uniformly distributed load = 40 kg
1 kg

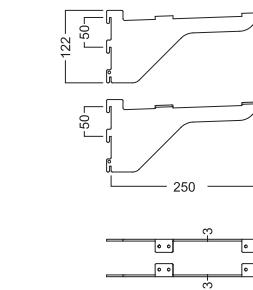
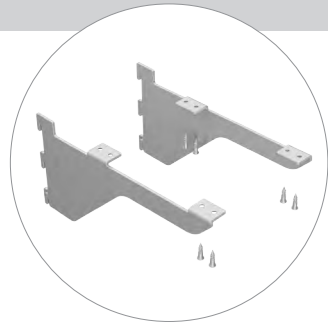

P 720

P 720.21

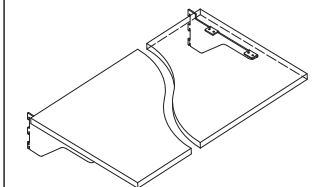

SHELF BRACKETS,
ADJUSTABLE

steel
left and right
incl. 8 countersunk screws P 700/20
for postformed shelf P 950/ 400 mm
or wooden shelf
front hanging (single row of slots)
0.722 kg

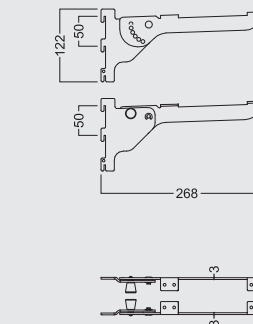
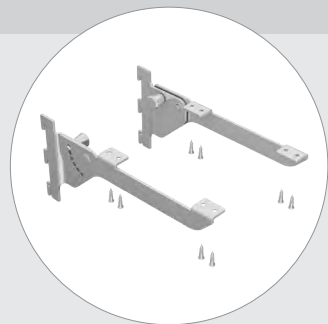

P 725

P 725.21

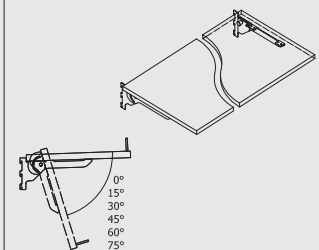

OCTAFRAME

SHELF BRACKETS, STRAIGHT

steel
left- and right-hand
incl. 8 countersunk screws P 700/20
supporting wooden shelf 19 mm and
thicker
front hanging (single row of slots)
max. uniformly distributed load = 40 kg
0.85 kg

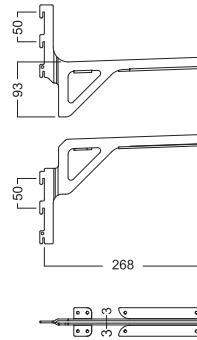
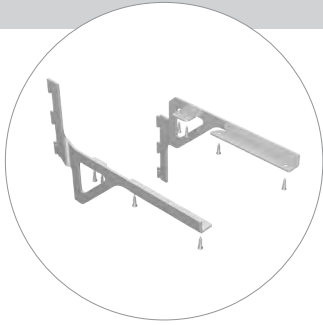

P 730

P 730.21

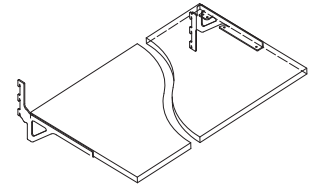

SHELF BRACKETS,
ADJUSTABLE

steel
left and right
incl. 8 countersunk screws P 700/20
for wooden shelf 19 mm and up
front hanging (single row of slots)
1 kg

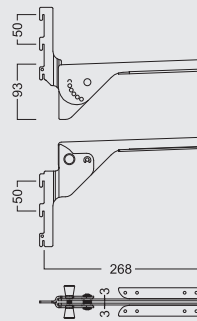
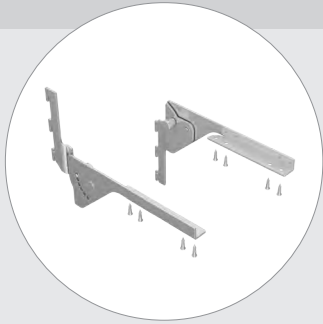

P 735

P 735.21

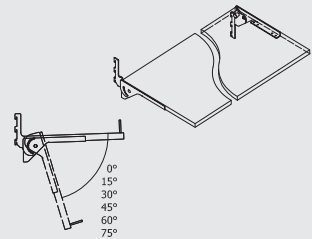

5

SHELF BRACKETS, STRAIGHT

steel
left- and right-hand
incl. 4 fixing screws
for supporting glass shelf 8 mm
front hanging (single row of slots)
max. uniformly distributed load = 20 kg
0.461 kg

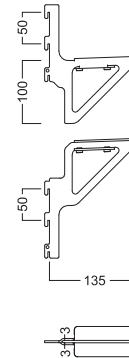
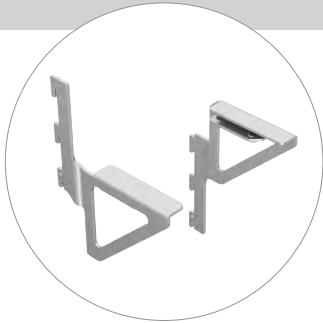

P 740

P 740.21

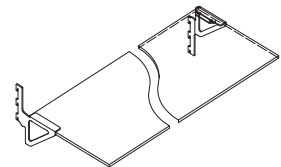

SHELF BRACKETS, STRAIGHT

steel
left- and right-hand
incl. 4 fixing screws
for supporting glass shelf 8 mm
front hanging (single row of slots)
max. uniformly distributed load = 20 kg
0.5 kg

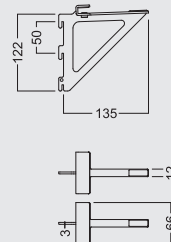
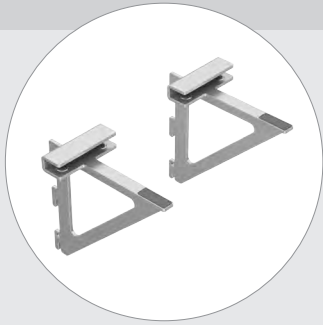

P 750

P 750.21

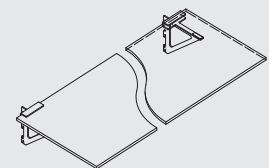

OCTAFRAME

SHELF BRACKETS, STRAIGHT

steel
left- and right-hand
incl. each 4 countersunk screws P 720/20
and P 780/20
for furniture units
front hanging (single row of slots)
0.35 kg

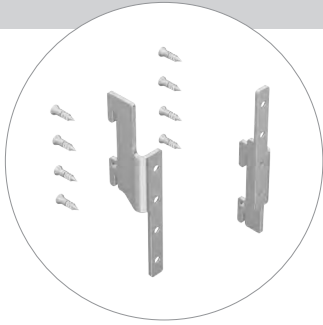

P 780

SHELF BRACKETS

P 780.21

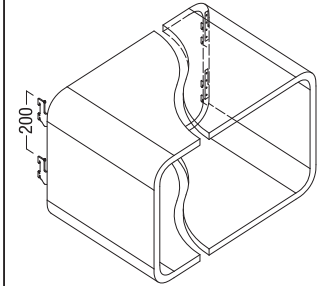

CLOTHES RAIL

steel
25 mm dia. round tube
incl. fixing accessories P 889
for use with brackets P 710
for 625 mm axis
615 mm long
0.9 kg

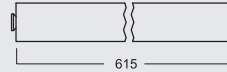
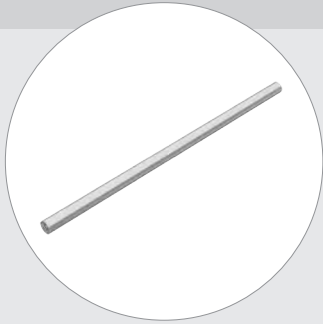

P 886

CLOTHES RAILS

P 886.39
P 886.41



CLOTHES RAIL

steel
25 mm dia. round tube
incl. fixing accessories P 889
for use with brackets P 710
for 1000 mm axis
990 mm long
1.3 kg

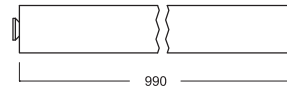
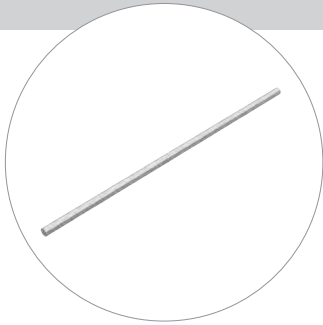

P 880

P 880.39
P 880.41

CLOTHES RAIL

steel
25 mm dia. round tube
for custom lengths
for use with brackets P 710
without fixing accessories P 889
2550 mm long
2.9 kg

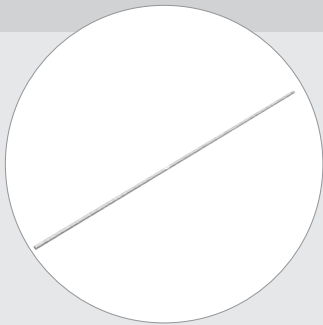

P 890

P 890.39
P 890.41

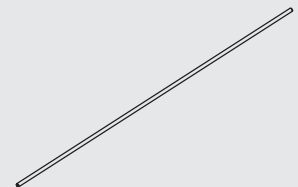

OCTAFRAME

FIXING-SET

steel
1 pair
for clothes rail P 890
0.15 kg

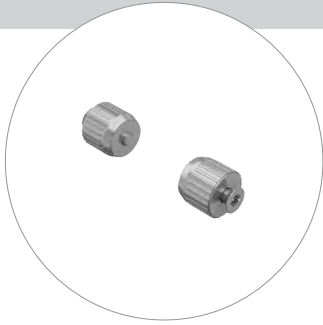

P 889

P 889.37

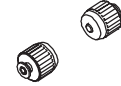

CLOTHES RAIL

steel
25 mm dia. round tube
front hanging (single row of slots)
max. uniformly distributed load = 35 kg
for 1000 mm axis
3.3 kg

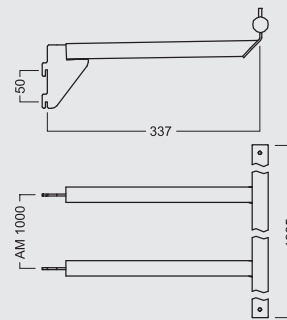
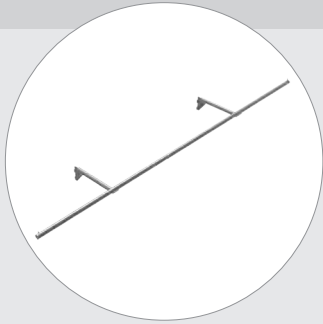

P 800

P 800.39
P 800.41

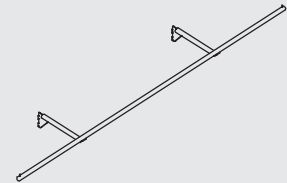

5

CLOTHES RAIL

steel
25 mm dia. round tube
front hanging (single row of slots)
max. uniformly distributed load = 35 kg
for 625 mm axis
2.4 kg

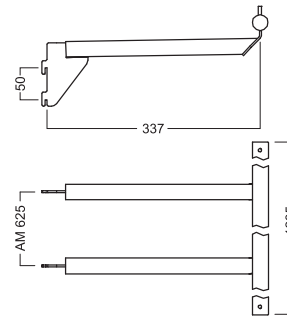
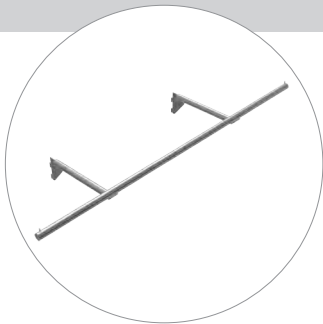

P 806

P 806.39
P 806.41

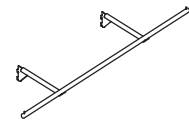

CLOTHES RAIL

steel
25 mm dia. round tube with groove
for suspension of **max. 3** hanging arms
P 840 - P 850
front hanging (single row of slots)
max. uniformly distributed load = 30 kg
for 1000 mm axis
2.9 kg

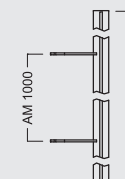
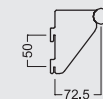
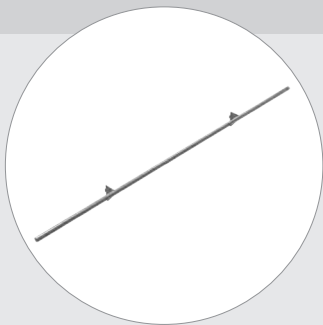

P 810

P 810.39
P 810.41

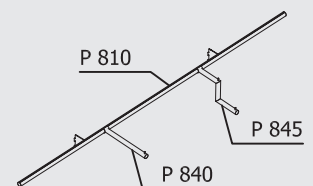

OCTAFRAME

CLOTHES RAIL

steel
25 mm dia. round tube with groove
for suspension of **max. 2** hanging arms
P 840 - P 850
front hanging (single row of slots)
max. uniformly distributed load = 30 kg
for 625 mm axis
1.9 kg

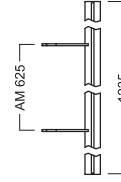
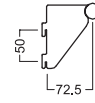
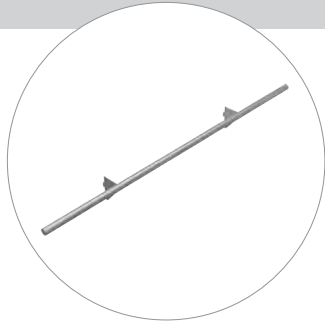

P 816

CLOTHES RAILS

P 816.39
P 816.41

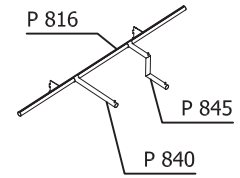

HANGING ARM / STRAIGHT

steel
25 mm dia. round tube
for cloths rail P 810, P 816
max. load = 15 kg
0.4 kg

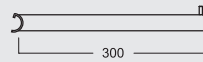
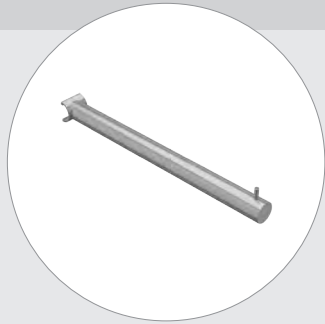

P 840

HANGING ARMS

P 840.39
P 840.41

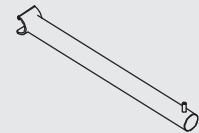

HANGING ARM / STEPPED

steel
25 mm dia. round tube
for clothes rail P 810, P 816
max. load = 15 kg
0.5 kg

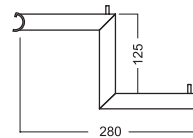
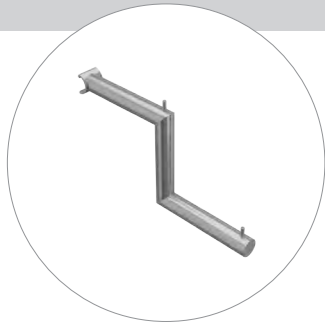

P 845

P 845.39
P 845.41

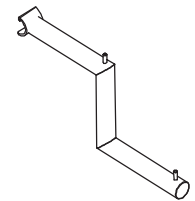

HANGING ARM / SLOPING

steel
25 mm dia. round tube
for clothes rail P 810, P 816
max. load = 15 kg
0.5 kg

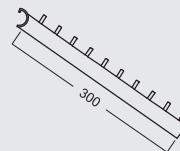

P 850

P 850.39
P 850.41

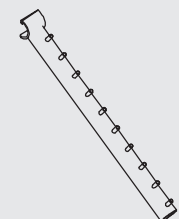

OCTAFRAME

HANGING ARM / STRAIGHT

steel
25 mm dia. round tube
with retaining screw
front hanging (single row of slots)
max. load = 20 kg
0.5 kg

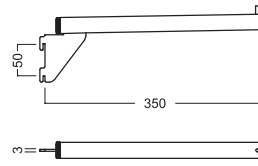

P 820

P 820.39
P 820.41

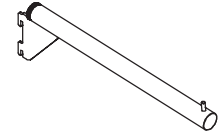

POSTFORMING WOODEN SHELF

MDF faced with high pressure laminate
postformed version
400 mm usable surface
excluding chamfered edges
other styles on request
4100 mm long
26.6 kg

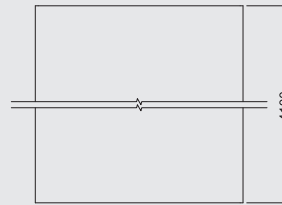
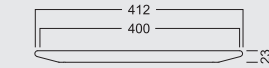

P 950

WOODEN SHELVES

P 950.30
P 950.31

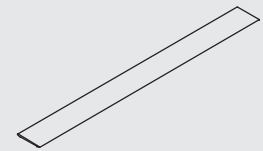

5

POSTFORMING WOODEN SHELF

MDF faced with high pressure laminate
postformed version
400 mm usable surface
excluding chamfered edges
other styles on request
615 mm long
4.02 kg

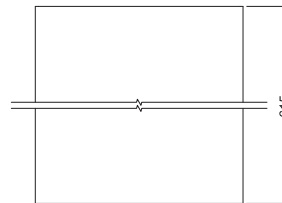
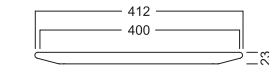

P 950-062

P 950-062.30
P 950-062.31

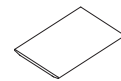

OCTAFRAME

POSTFORMING WOODEN SHELF

MDF faced with high pressure laminate
postformed version
400 mm usable surface
excluding chamfered edges
other styles on request
990 mm long
6.48 kg

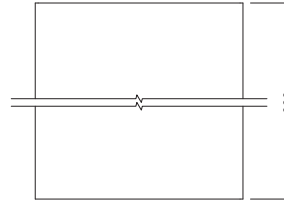
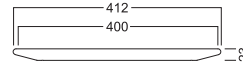

P 950-100

WOODEN SHELVES

P 950-100.30
P 950-100.31

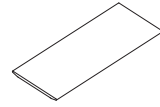

POSTFORMING WOODEN SHELF

MDF faced with high pressure laminate
postformed version
400 mm usable surface
with chamfered edges
other styles on request
1240 mm long
8.1 kg

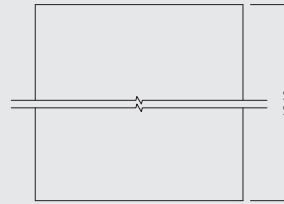
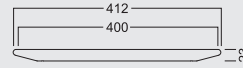

P 950-125

P 950-125.30
P 950-125.31

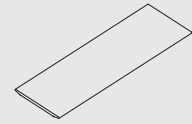

POSTFORMING WOODEN SHELF

MDF faced with high pressure laminate
postformed version
400 mm usable surface
with chamfered edges
other styles on request
1990 mm long
12.96 kg

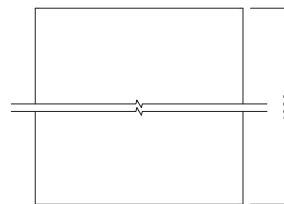
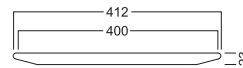

P 950-200

P 950-200.30
P 950-200.31

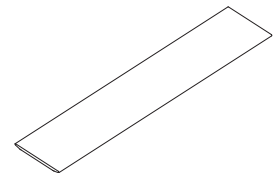

ELLIPTICAL
EXTRUSIONS

ELLIPTICAL EXTRUSION

aluminium
with 2 system grooves
5000 mm long
5.59 kg

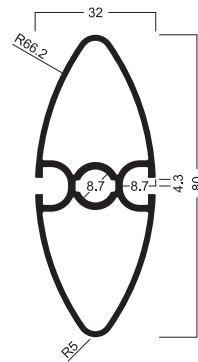

S 6104

ELLIPTICAL
EXTRUSIONS

S 6104.01

ELLIPTICAL EXTRUSION

aluminium
with 3 system grooves
5000 mm long
7.65 kg

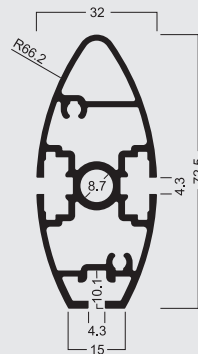

S 6105

S 6105.01

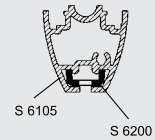

5

INSERT EXTRUSION

aluminium
for all extrusions with system groove
4.3 mm
5000 mm long
0.78 kg



S 6110

S 6110.01

decorative strips
optional
17 x 2
wahlweise
Dekorstreifen
17 x 2

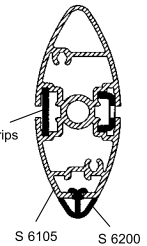

END PLATE

steel
right/left version
for extrusion S 6105
1 pair
0.096 kg

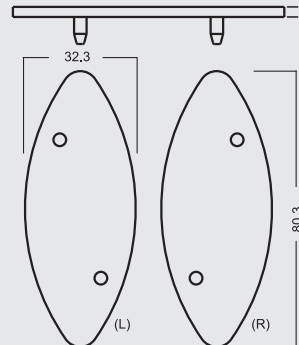
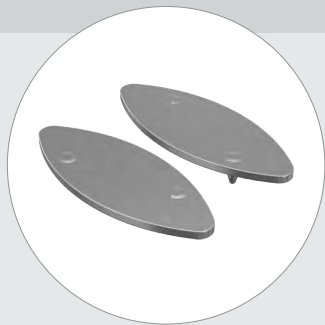

S 6130

S 6130.21

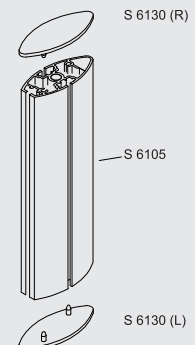

**ELLIPTICAL
EXTRUSIONS**

END PLATE

steel
incl. 2 countersunk screws M4
right/left version
for extrusion S 6105
1 pair
0.1 kg

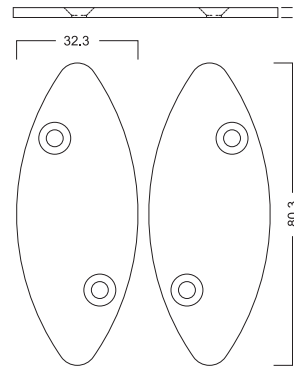

S 6132

**ELLIPTICAL
EXTRUSIONS**

S 6132.21

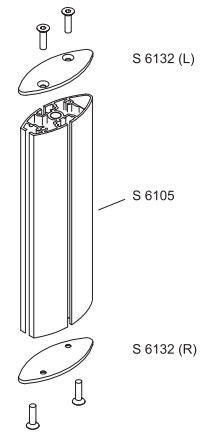

SLOTTED INSERT RAIL

steel
for use with extrusion S 6105
2680 mm long
0.731 kg

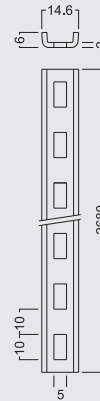

S 6200

**SLOTTED
INSERT RAILS**

S 6200.44

**BRACKET FOR
WOODEN SHELVES**

steel
to connect to slotted insert rail S 6200
for wooden shelves, depth 350 mm max.
0.056 kg

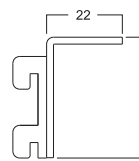
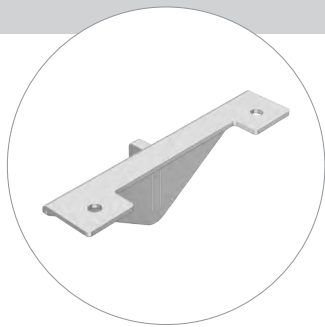

S 6218

SHELF BRACKETS

S 6218.21

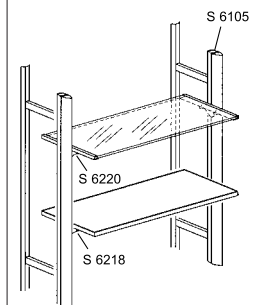

ELLIPTICAL
EXTRUSIONS

BRACKET FOR GLASS SHELF

steel
incl. 2 clamping screws M4 and
shelf bracket S 6218
to connect to slotted insert rail S 6200
0.232 kg

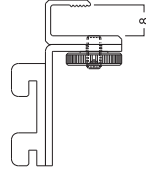

S 6220

S 6220.21

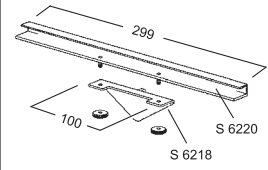

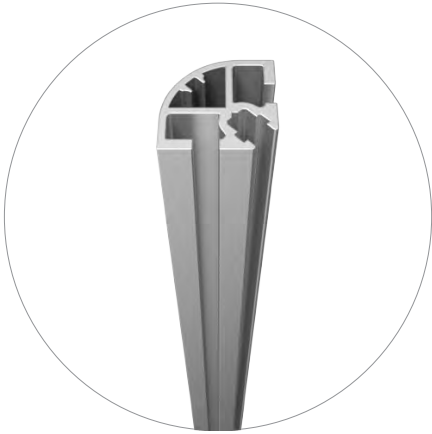

Quarter Round Extrusions | 20 x 20 mm
198

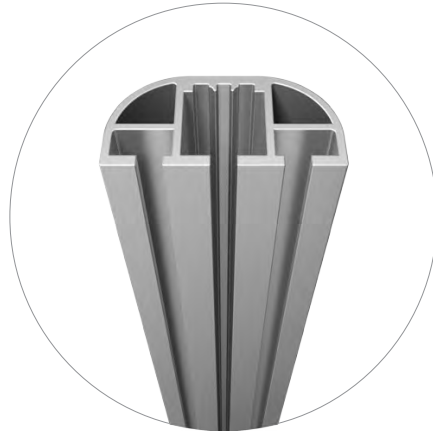

Quarter Round Extrusions | 40 x 20 mm
199



Quarter Round Extrusions | 22 x 22 mm
199

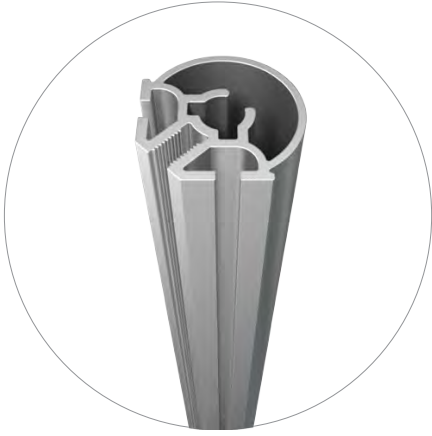

Quarter Round Extrusions | 32 x 32 mm
200



Quarter Round Extrusions | 64 x 32 mm
201

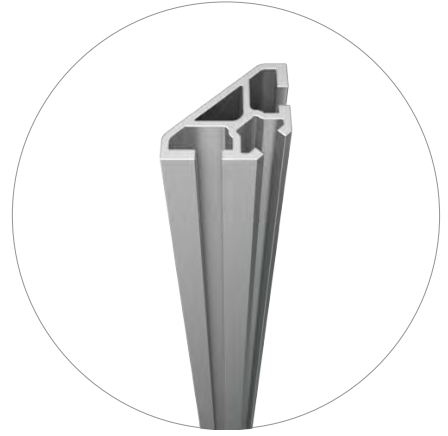

Triangular Extrusions | 22 x 22 mm
204

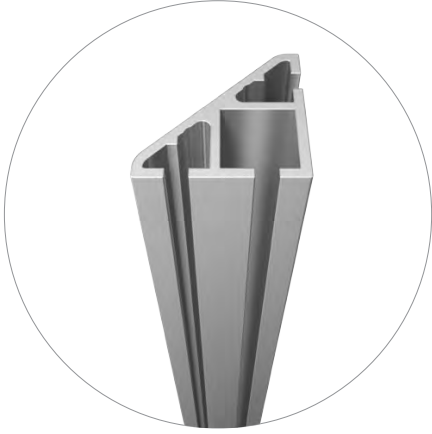

Triangular Extrusions | 32 x 32 mm
204

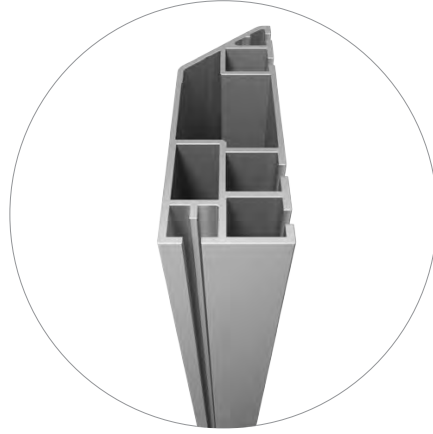

Triangular Extrusions | 100 x 32 mm
205



Square Extrusions | 18 x 18 mm
207



Square Extrusions | 22 x 22 mm
208



Square Extrusions | 25 x 25 mm
208

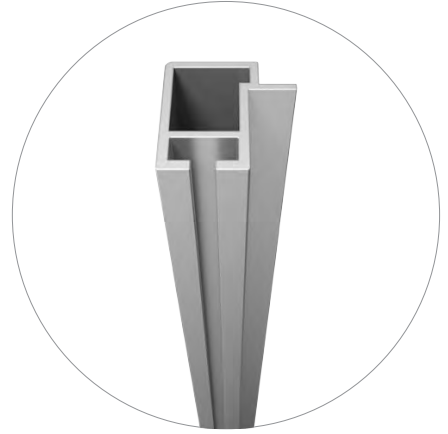

Square Extrusions | 26 x 25 mm
209

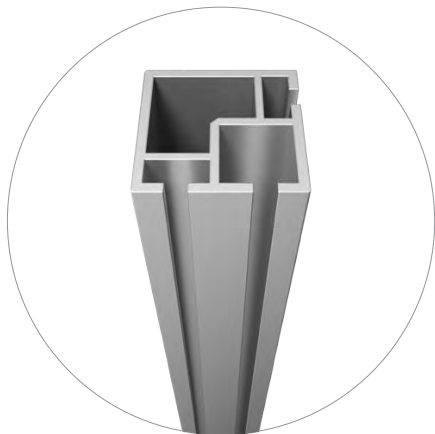

Square Extrusions | 32 x 32 mm

210

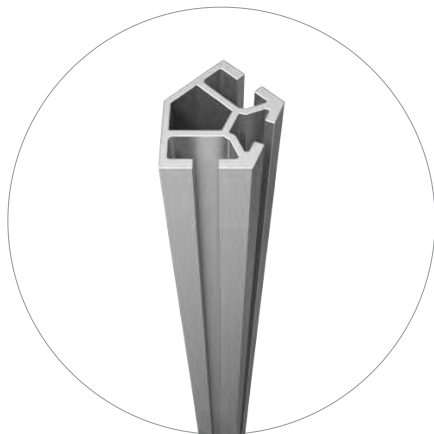

135°-Extrusions

213



Beam Extrusions | 25 x 12 mm

216



Beam Extrusions | 30 x 12 mm

216

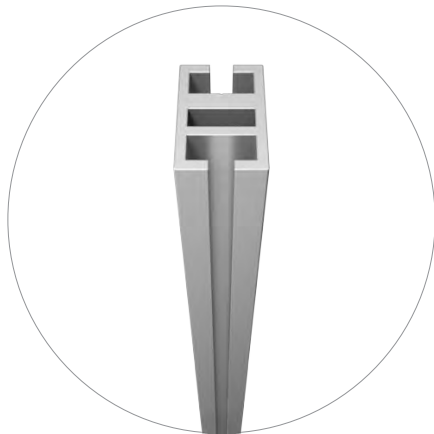

Beam Extrusions | 25 x 16 mm

217

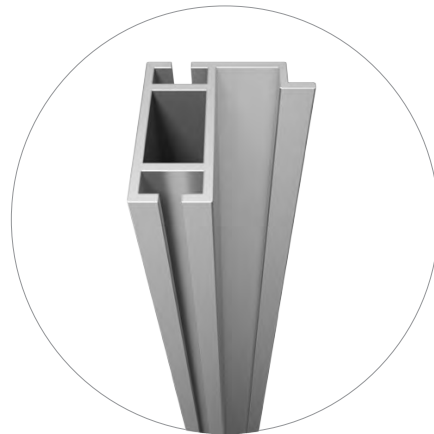

Beam Extrusions | 40 x 32 mm

218



Beam Extrusions | 40 x 16 mm

218

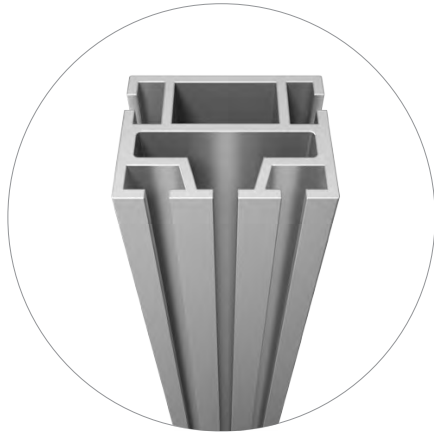

Beam Extrusions | 40 x 32 mm

219

6

FURNISHING SYSTEMS

QUARTER ROUND EXTRUSIONS

QUARTER-ROUND EXTRUSION

aluminium
5000 mm long
1.995 kg

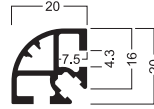

M 1600

20 X 20 MM

M 1600.01

END CAP

plastic
for quarter-round extrusion M 1600

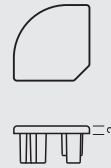

M 1630

M 1630.35



KNUCKLE JOINT

zinc die cast
incl. 2 set screws E 111/4*4
for mounting 2 quarter-round extrusions
M 1600
0.043 kg

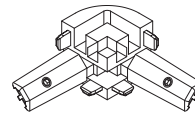

M 1632

M 1632.39

KNUCKLE JOINT

zinc die cast
incl. 3 set screws E 111/4*4
for mounting 3 quarter-round extrusions
M 1600
0.043 kg

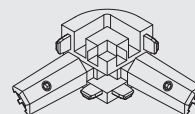

M 1633

M 1633.39
M 1633.41



FURNISHING SYSTEMS

QUARTER ROUND EXTRUSIONS

SEMI-CIRCULAR EXTRUSION

aluminium
5000 mm long
3.21 kg

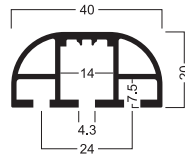

M 1606

40 X 20 MM

M 1606.01

END CAP

plastic
for semi-circular extrusion M 1606
0.002 kg

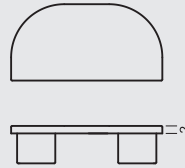

M 1660

M 1660.35



KNUCKLE JOINT

zinc die cast
incl. 2 set screws E 111/4*8
for mounting 2 semi-circular extrusions
M 1606
0.092 kg

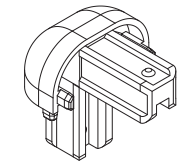

M 1662

M 1662.39
M 1662.41

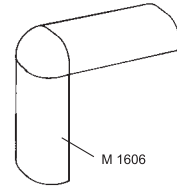

QUARTER-ROUND EXTRUSION

aluminium
5000 mm long
1.8 kg

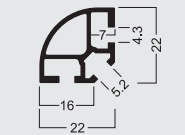

M 1620

22 X 22 MM

M 1620.01

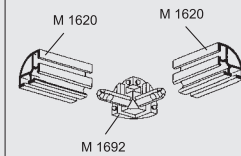

6

FURNISHING SYSTEMS

QUARTER ROUND EXTRUSIONS

KNUCKLE JOINT

zinc die cast
incl. 2 set screws M 1431/20 (M4)
for mounting 2 quarter-round extrusions
M 1620
0.057 kg

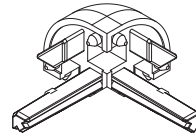

M 1692

22 X 22 MM

M 1692.39

KNUCKLE JOINT

zinc die cast
incl. 3 set screws M 1431/20 (M4)
for mounting 3 quarter-round extrusions
M 1620
0.07 kg

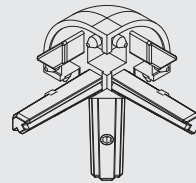

M 1693

M 1693.39

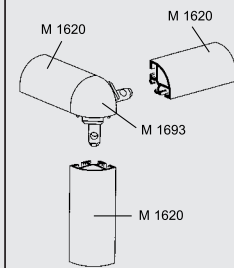

QUARTER-ROUND EXTRUSION

aluminium
5000 mm long
3.78 kg

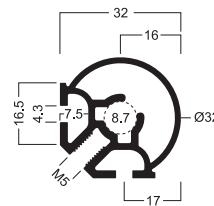

S 1200

32 X 32 MM

S 1200.01

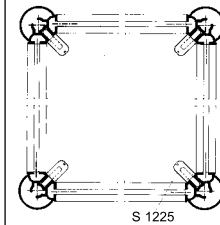

END CAP

plastic
for quarter-round extrusion S 1200
0.003 kg

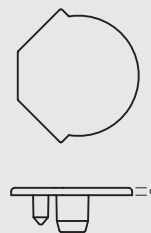

S 1230

S 1230.35

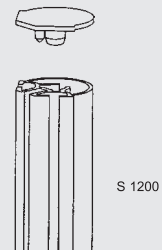

FURNISHING SYSTEMS

QUARTER ROUND EXTRUSIONS

QUARTER-ROUND EXTRUSION

aluminium
5000 mm long
4.06 kg

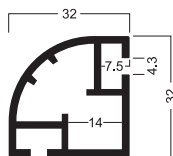

S 1100

S 1100.01

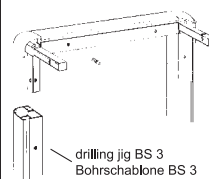

QUARTER-ROUND EXTRUSION

aluminium
5000 mm long
4.21 kg

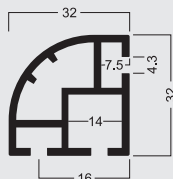

S 1105

S 1105.01

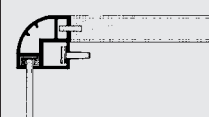

SEMI-CIRCULAR EXTRUSION

aluminium
5000 mm long
6.98 kg

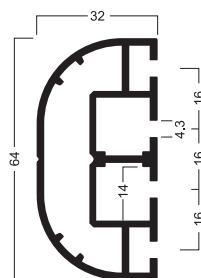
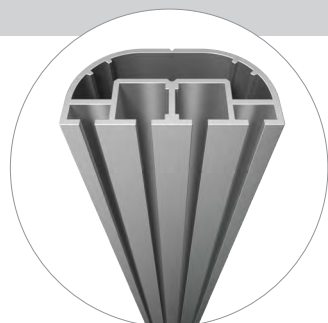

S 1106

64 X 32 MM

S 1106.01

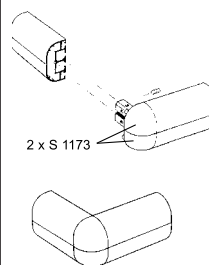

6

END CAP

plastic
for quarter-round extrusions S1100, S 1105
0.004 kg

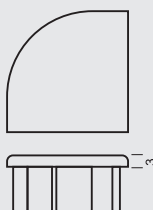

S 1130

S 1130.35

FURNISHING SYSTEMS

QUARTER ROUND EXTRUSIONS

END PLATE

zinc die cast
for quarter-round extrusions S 1100, S 1105
0.036 kg

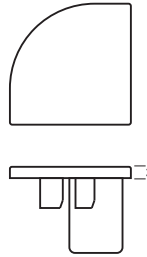

S 1131

64 X 32 MM

S 1131.39

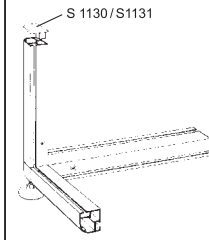

THREADED INSERT

zinc die cast
thread M10
for quarter-round extrusions S 1100,
S 1105
0.035 kg

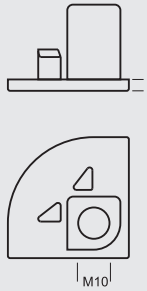

S 1132

S 1132.00

KNUCKLE JOINT

zinc die cast
incl. 2 countersunk screws E 111/m (M6)
and 2 set screws E 111/g (M6)
for mounting 2 quarter-round extrusions
S 1100, S 1105, S 1106
0.201 kg

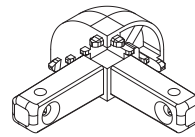

S 1173

S 1173.39

KNUCKLE JOINT

zinc die cast
incl. 3 countersunk screws E 111/m (M6)
and 3 set screws E 111/g (M6)
for mounting 3 quarter-round extrusions
S 1100, S 1105
0.244 kg

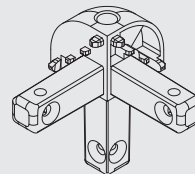

S 1170

S 1170.39

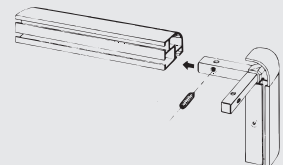

QUARTER ROUND
EXTRUSIONS

KNUCKLE JOINT

zinc die cast
with thread M10 (20 mm deep)
incl. 3 countersunk screws E 111/m (M6)
and 3 set screws E 111/g (M6)
for mounting 3 quarter-round extrusions
S 1100, S 1105
0.232 kg

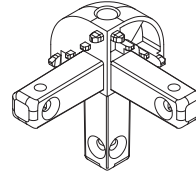

S 1171

S 1171.39

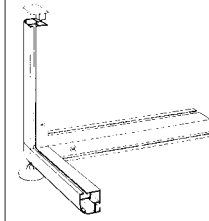

FURNISHING SYSTEMS

TRIANGULAR EXTRUSIONS

TRIANGULAR EXTRUSION

aluminium
5000 mm long
1.77 kg

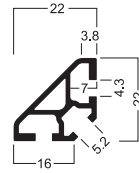

M 1622

22 X 22 MM

M 1622.01
M 1622.41

END PLATE

zinc die cast
for triangular extrusion M 1622
0.009 kg

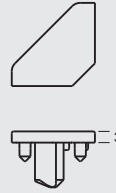

M 1650

M 1650.39
M 1650.41

KNUCKLE JOINT

zinc die cast
incl. 3 set screws M 1431/20 (M4)
for mounting 3 triangular extrusions
M 1622
0.043 kg

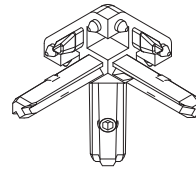

M 1653

M 1653.39
M 1653.41

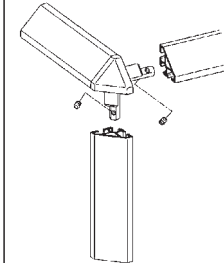

TRIANGULAR EXTRUSION

aluminium
5000 mm long
3.196 kg

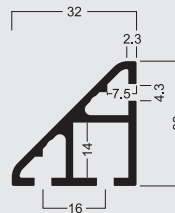

S 1303

32 X 32 MM

S 1303.01

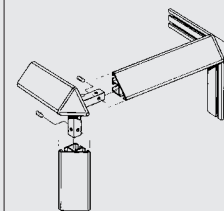

TRIANGULAR EXTRUSIONS

TRIANGULAR EXTRUSION

aluminium
5000 mm long
9.28 kg

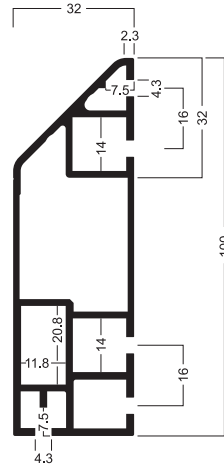

S 1310

100 X 32 MM

S 1310.01

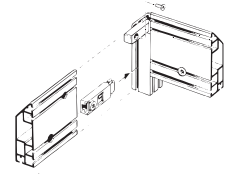

drilling jig BS 6
with distance block ZBS-140
Bohrschablone BS 6
mit Distanzblock ZBS-140

END PLATE

zinc die cast
for triangular extrusion S 1303
0.03 kg

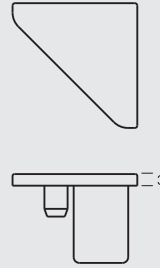

S 1334

S 1334.39
S 1334.41



THREADED INSERT

zinc die cast
with female thread M10
for triangular extrusion S 1303
0.03 kg

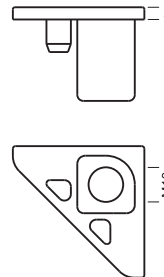

S 1336

S 1336.00

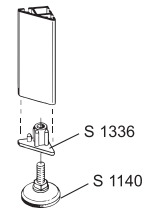

KNUCKLE JOINT

zinc die cast
incl. 2 countersunk screws E 111/m (M6)
and 2 set screws E 111/g (M6)
for mounting 2 triangular extrusions S 1303
0.146 kg

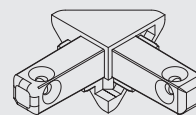

S 1332

S 1332.39
S 1332.41

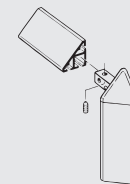

TRIANGULAR
EXTRUSIONS

KNUCKLE JOINT

zinc die cast
incl. 3 countersunk screws E 111/m (M6)
and 3 set screws E 111/g (M6)
for mounting 3 triangular extrusions
S 1303, S 1310
0.184 kg

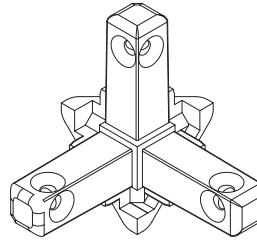

S 1333

100 X 32 MM

S 1333.39
S 1333.41

KNUCKLE JOINT 135°

zinc die cast
incl. 2 countersunk screws E 111/m (M6)
and 2 set screws E 111/g (M6)
for mounting 2 triangular extrusions S 1303
0.186 kg

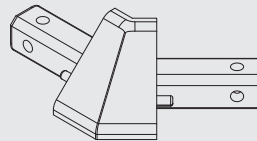
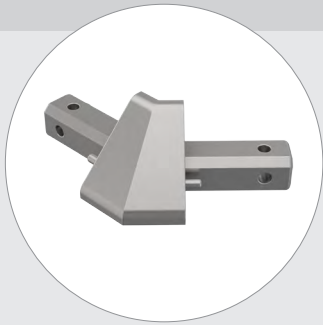

S 1338

S 1338.39
S 1338.41

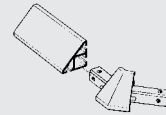

SQUARE EXTRUSIONS

SQUARE EXTRUSION 18 MM

aluminium
5000 mm long
1.994 kg

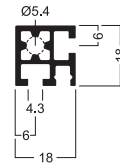

M 1618

18 X 18 MM

M 1618.01

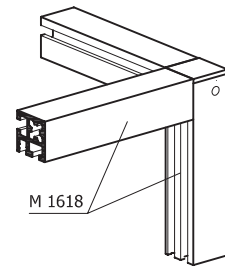

END CAP

plastic
for square extrusion M 1618

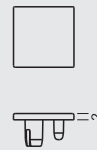

M 1631

M 1631.35

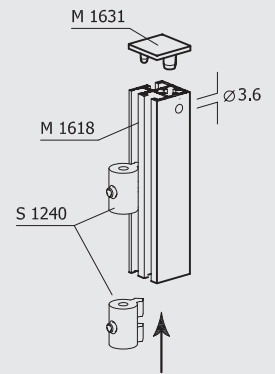

COUPLING PIN

steel
for connection of square extrusions M 1618
0.004 kg

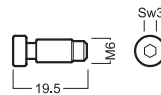

M 1639

M 1639.37

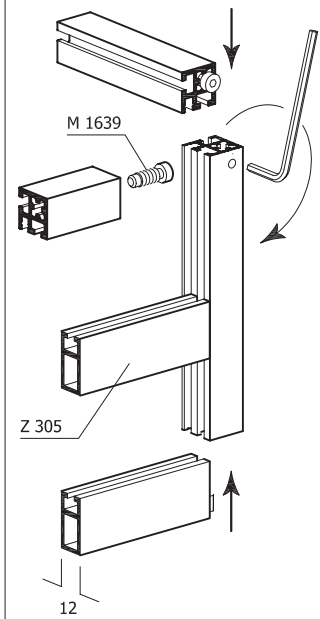

FURNISHING SYSTEMS

SQUARE EXTRUSIONS

SQUARE EXTRUSION 22 MM

aluminium
5000 mm long
2.15 kg

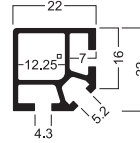

M 1625

22 X 22 MM

M 1625.01

END CAP

plastic
for square extrusions M 1625

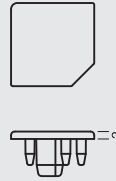

M 1665

M 1665.35

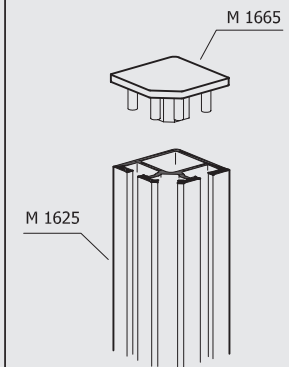

KNUCKLE JOINT

zinc die cast
incl. 3 set screws M 1431/20 (M4)
for mounting 3 square extrusions M 1625
0.092 kg

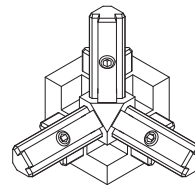

M 1683

M 1683.39

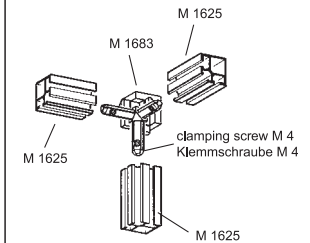

SQUARE EXTRUSION 25 MM

aluminium
5000 mm long
2.89 kg

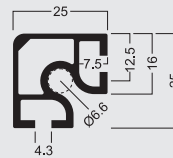

V 2000

25 X 25 MM

V 2000.01

FURNISHING SYSTEMS

SQUARE EXTRUSIONS

KNUCKLE JOINT

zinc die cast
incl. 3 countersunk screws E 2600/20 (M5)
for mounting 3 extrusions V 2000
0.157 kg

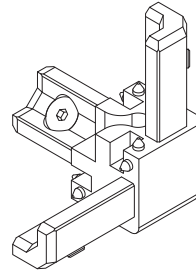
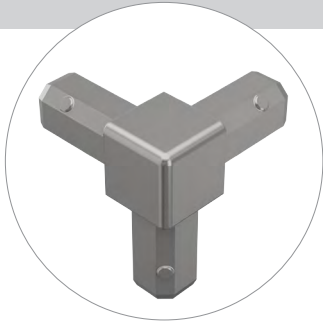

V 2070

V 2070.39

ADJUSTABLE FOOT

steel
height adjustable from 31 - 49 mm
for square extrusion V 2000
0.073 kg

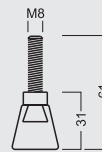

V 2214

V 2214.37

FRAME EXTRUSION
(EXTERNAL)

aluminium
5000 mm long
2.29 kg

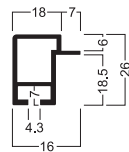
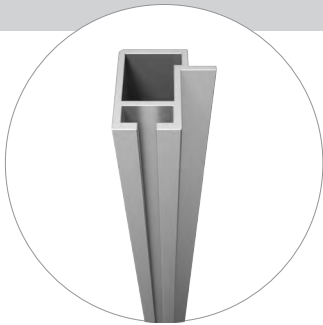

V 2100

26 X 25 MM

V 2100.01

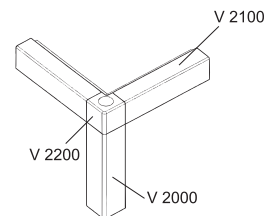

KNUCKLE JOINT

plastic
incl. 1 cylinder screw V 2211 (M8)
2 countersunk screws V 2212 and
1 cover plate V 2210
for mounting 1 extrusion V 2000 and
2 extrusions V 2100
0.044 kg

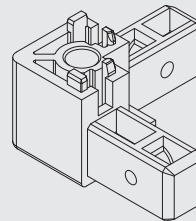
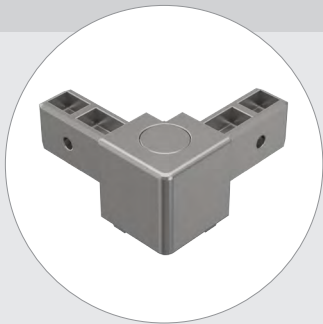

V 2200

V 2200.35

V 2200.36

FURNISHING SYSTEMS

SQUARE EXTRUSIONS

FIXING CLIP

spring steel
for glass cover plate **4 mm**
0.002 kg

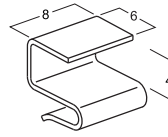
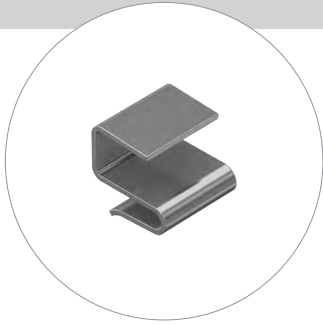

V 2234

26 X 25 MM

V 2234.41

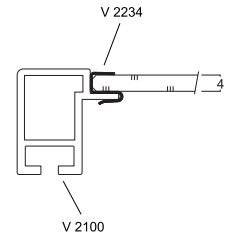

FIXING CLIP

spring steel
for glass cover plate **6 mm**

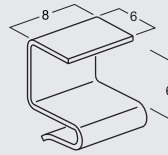
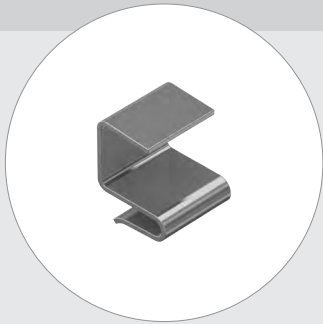

V 2236

V 2236.41

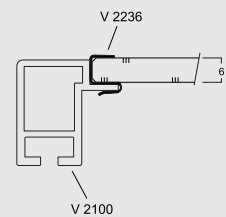

SQUARE EXTRUSION 32 MM

aluminium
5000 mm long
4.31 kg

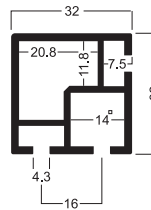
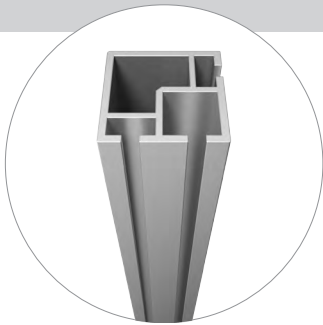

S 1125

32 X 32 MM

S 1125.01

END PLATE

zinc die cast
for square extrusion S 1125
0.032 kg

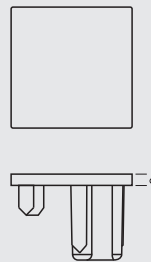
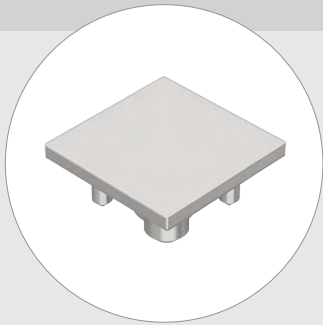

S 1142

S 1142.39

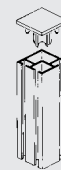

KNUCKLE JOINT

zinc die cast
incl. 2 countersunk screws E 111/m (M6)
and 2 set screws E 111/g (M6)
for mounting 2 square extrusions S 1125
0.22 kg

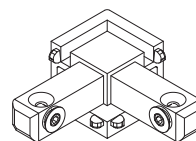

S 1192

S 1192.39

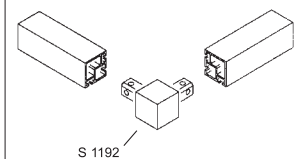

SQUARE EXTRUSIONS

KNUCKLE JOINT

zinc die cast
incl. 3 countersunk screws E 111/m (M6)
and 3 set screws E 111/g (M6)
for mounting 3 square extrusions S 1125
0.254 kg

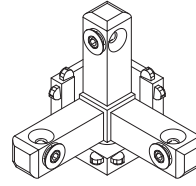
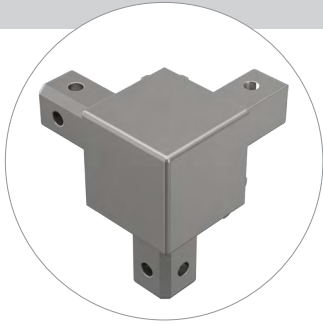

S 1190

S 1190.39

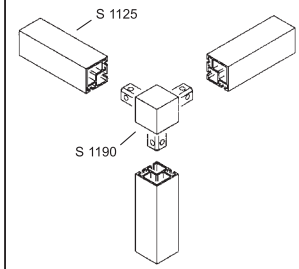

KNUCKLE JOINT

zinc die cast
incl. 3 countersunk screws E 111/m (M6)
and 3 set screws E 111/g (M6)
for mounting 2 quarter-round S 1105
and 1 square extrusion S 1125
0.25 kg

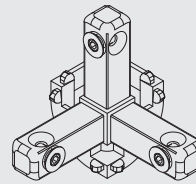
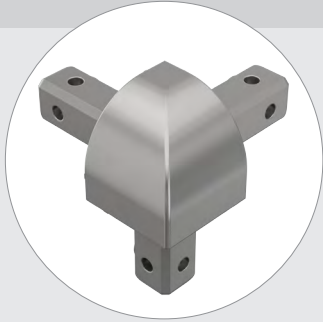

S 1175

S 1175.39

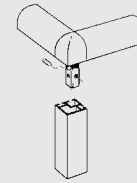

KNUCKLE JOINT

zinc die cast
incl. 3 countersunk screws E 111/m (M6)
and 3 set screws E 111/g (M6)
for mounting 1 quarter-round extrusion
S 1105 and 2 square extrusions S 1125
0.249 kg

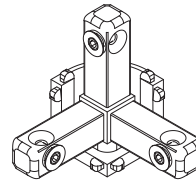
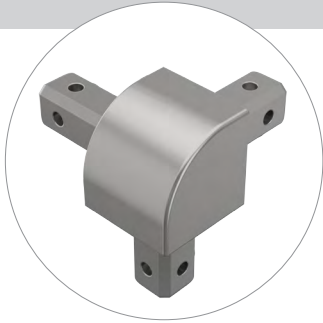

S 1180

S 1180.39

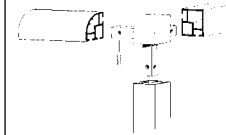

KNUCKLE JOINT

zinc die cast
incl. 3 countersunk screws E 111/m (M6)
and 3 set screws E 111/g (M6)
for mounting 2 triangular extrusion S 1303
and 1 square extrusion S 1125
0.217 kg

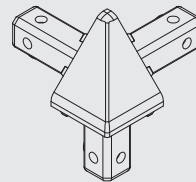

S 1340

S 1340.39
S 1340.41

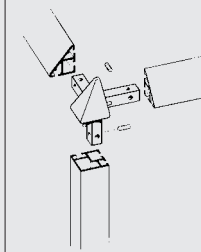

SQUARE EXTRUSIONS

KNUCKLE JOINT

S 1341

32 X 32 MM

zinc die cast
 incl. 3 countersunk screws E 111/m (M6)
 and 3 set screws E 111/g (M6)
 for mounting 1 triangular extrusion S1303
 and 2 square extrusions S 1125
 0.221 kg

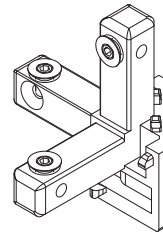
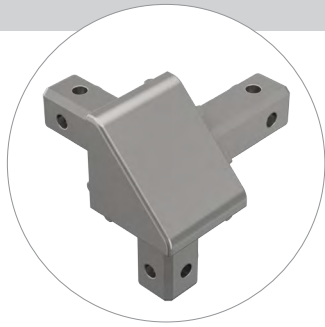

S 1341.39
 S 1341.41

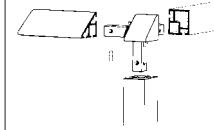

135°-EXTRUSIONS

EXTERIOR CORNER EXTRUSION 135°

aluminium
for extrusion M 1622
5000 mm long
2.15 kg

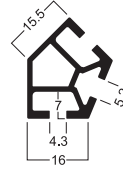
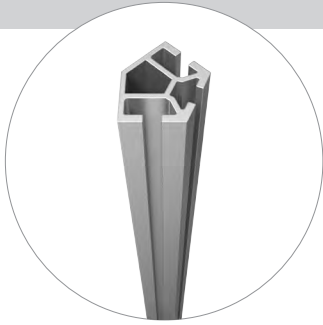

M 1629

M 1629.01
M 1629.41

END PLATE

zinc die cast
for corner extrusion M 1629
0.011 kg

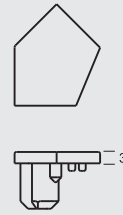

M 1685

M 1685.41

KNUCKLE JOINT 135°

zinc die cast
incl. 3 set screws M 1431/20 (M4)
for mounting 2 triangular extrusions
M 1622 and 1 corner extrusion
M 1629
0.055 kg

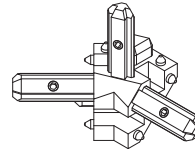
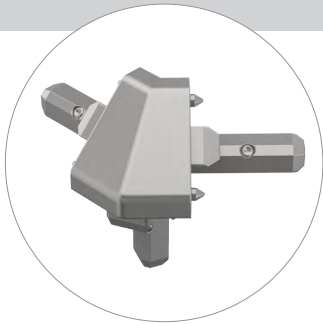

M 1689

M 1689.39
M 1689.41

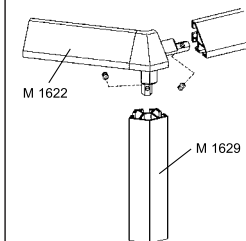

6

EXTERIOR CORNER EXTRUSION 135°

aluminium
for extrusion V 2100
5000 mm long
2.63 kg



V 2020

V 2020.01

135°-EXTRUSIONS

KNUCKLE JOINT 135°

plastic
incl. 1 cylinder screw V 2211 (M8)
2 countersunk screws V 2212 and
1 cover plate V 2210
for mounting 1 extrusion V 2020 and
2 extrusions V 2100
0.04 kg

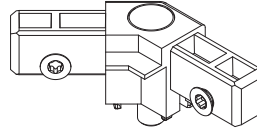

V 2202

V 2202.36

EXTERIOR CORNER EXTRUSION 135°

aluminium
for extrusions S 1100, S 1105, S 1303
5000 mm long
4.74 kg

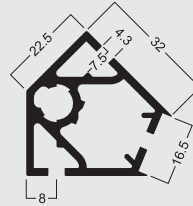
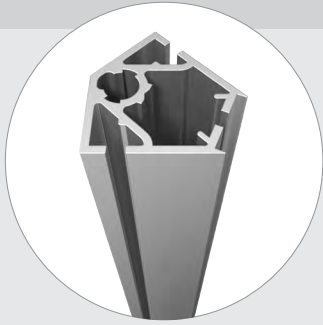

S 1129

S 1129.01

END PLATE

zinc die cast
for corner extrusion S 1129
0.04 kg

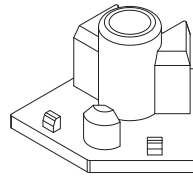

S 1148

S 1148.39

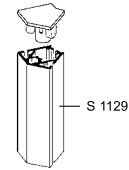

KNUCKLE JOINT 135°

zinc die cast
incl. 2 countersunk screws E 111/m (M6)
and 3 set screws E 111/g (M6)
for mounting 2 quarter-round S 1105
and 1 corner extrusion S 1129
0.286 kg

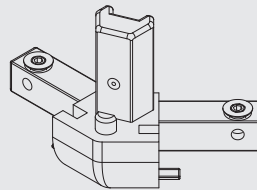
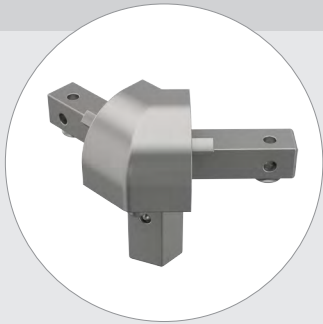

S 1179

S 1179.39

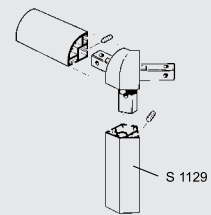

135°-EXTRUSIONS

KNUCKLE JOINT 135°

zinc die cast
 incl. 2 countersunk screws E 111/m (M6)
 and 3 set screws E 111/g (M6)
 for mounting 2 triangular S 1303
 and 1 corner extrusion S 1129
 0.254 kg

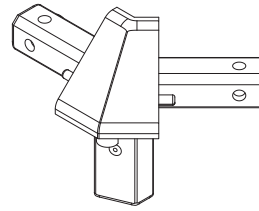

S 1339

S 1339.39
 S 1339.41

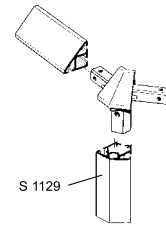

FURNISHING SYSTEMS

BEAM EXTRUSIONS

BEAM EXTRUSION 25 MM

aluminium
5000 mm long
1.715 kg

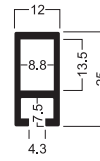

Z 305

25 X 12 MM

Z 305.01

BEAM EXTRUSION 30 MM

aluminium
5000 mm long
2.075 kg

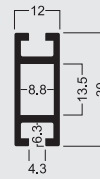

Z 306

30 X 12 MM

Z 306.01

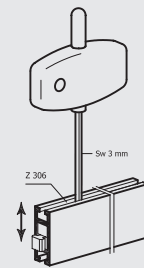

CLAMPING ELEMENT

steel
for beam extrusion Z 305, Z 306
0.044 kg

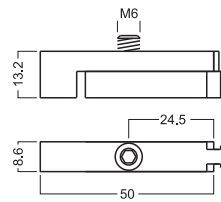

Z 950

Z 950.37

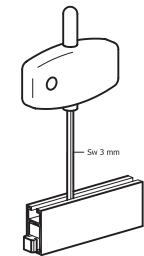

PRESSPIN

steel
M5, for clamping element Z 950
makes repeated mounting and dismounting
of the beam Z 305, Z 306 easier



Z 950/D

Z 950/D.43

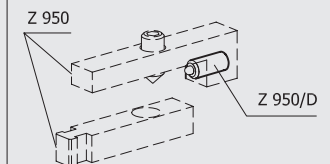

BEAM EXTRUSIONS

BEAM EXTRUSION 25 MM

aluminium
5000 mm long
2.715 kg

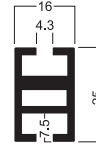

M 1602

25 X 16 M

M 1602.01

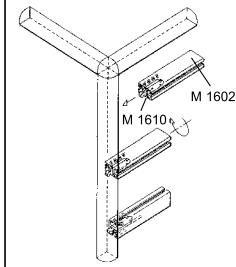

BEAM EXTRUSION 25 MM

aluminium
5000 mm long
2.74 kg

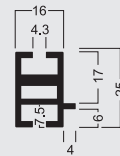

M 1603

M 1603.01

CLAMPING ELEMENT

steel
incl. set screw M 1075/20 (M4) and rubber
ring
as a mounting auxiliary
universal use right/left
for extrusions M 1602, M 1603
0.021 kg

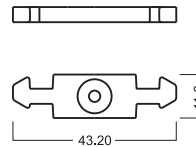
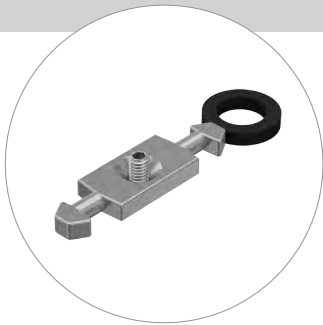

M 1610

M 1610.37

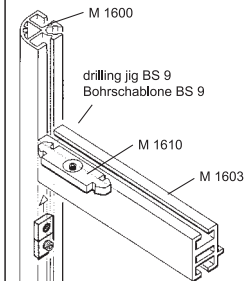

In case high loads have to
be borne!
Anti slipping device M 1636
with set screw M4

Abhilfe bei hohen Belastungen!
Rutschsicherung M 1636 mit
Madenschraube M4

6

BEAM EXTRUSION 32 MM

aluminium
tension lock Z 961/13 can be mounted
groove depth 7 mm
5000 mm long
2.68 kg

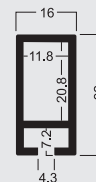

Z 308

Z 308.01
Z 308.11

BEAM EXTRUSIONS

END CAP

plastic
for extrusion Z 308
0.003 kg

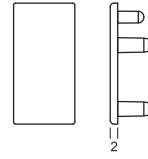
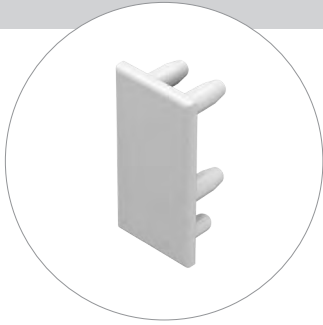

Z 976

25 X 16 M

Z 976.30
Z 976.35

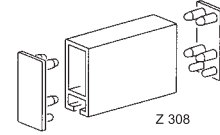

BEAM EXTRUSION 40 MM

aluminium
tension lock Z 961/13 can be mounted
5000 mm long
4.14 kg

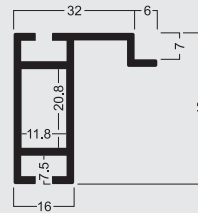
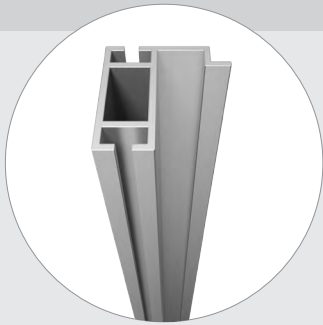

Z 4100

40 X 32 MM

Z 4100.01

drilling jig BS 6/13 with
distance block ZBS-140
Bohrschablone BS 6/13
mit Distanzblock ZBS-140

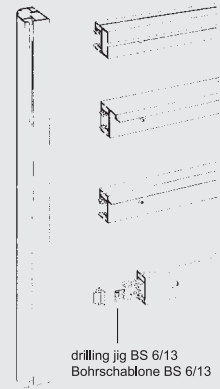

BEAM EXTRUSION 40 MM

aluminium
tension lock Z 961/13 can be mounted
5000 mm long
3.54 kg

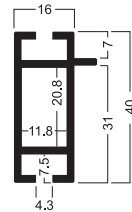

Z 4300

40 X 16 MM

Z 4300.01

BEAM EXTRUSION 40 X 16 MM

aluminium
tension lock Z 961/13 can be mounted
5000 mm long
3.38 kg

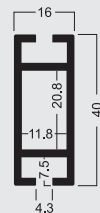

Z 4400

Z 4400.01

FURNISHING SYSTEMS

BEAM EXTRUSIONS

BEAM EXTRUSION 40 MM

aluminium
tension lock Z 961/13 can be mounted
5000 mm long
3.38 kg

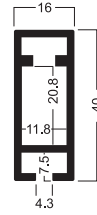

Z 4401

Z 4401.01

END CAP

plastic
for beam extrusions Z 4100, Z 4300,
Z 4400, Z 4401
0.002 kg

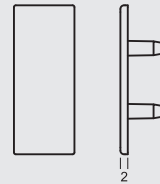

Z 4430

Z 4430.35

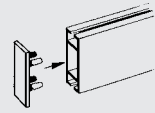

RECTANGULAR EXTRUSION 40 MM

aluminium
5000 mm long
3.485 kg

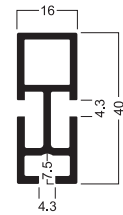

Z 4700

Z 4700.01

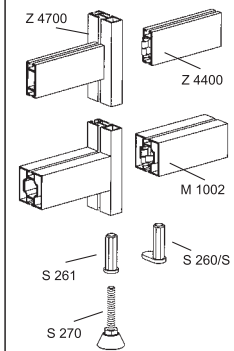

6

BEAM EXTRUSION 40 MM

aluminium
tension lock Z 961/13 can be mounted
5000 mm long
5.99 kg

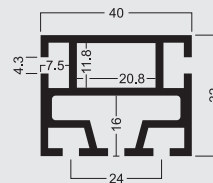

Z 2100

40 X 32 MM

Z 2100.01

BEAM EXTRUSIONS

BEAM EXTRUSION 40 MM

aluminium
tension lock Z 961/13 can be mounted
5000 mm long
5.56 kg

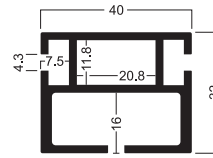

Z 2105

40 X 32 MM

Z 2105.01

END PLATE

zinc die cast
for beam extrusions Z 2100, Z 2105
0.042 kg

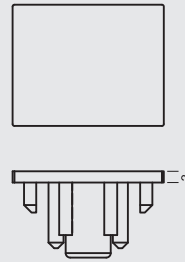

Z 2131

Z 2131.39

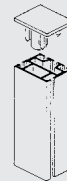

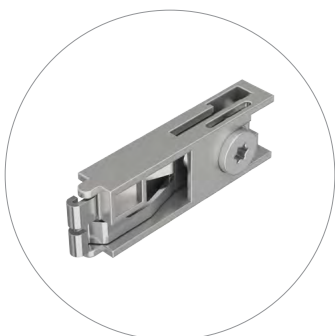

Tension Locks | Straight
224



Tension Locks | Curved
226



Tension Locks | 22,5°
227



Tension Locks | 45°
228

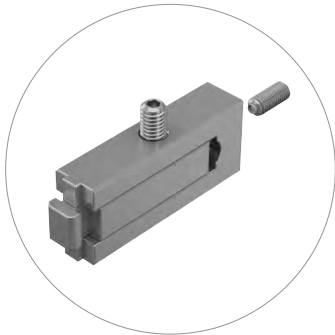

Tension Locks | Clamping Elements
229



Glass and Panel retainer
231

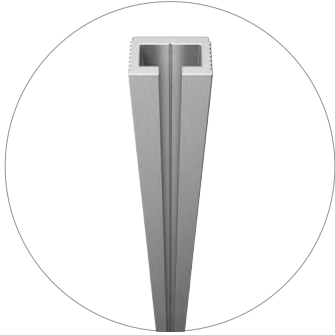

Glass and Panel extrusions
242



Cover and cable retainer extrusions
247

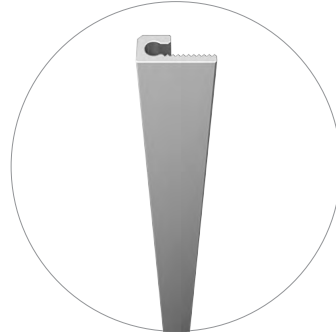

Edge protection extrusions
252



Connector Extrusions
253



Connectors
254

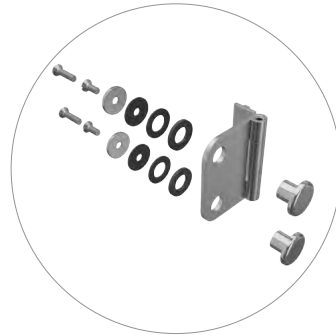

Hinge Plates and Hinges
268



Showcase and Furniture Accessories
272

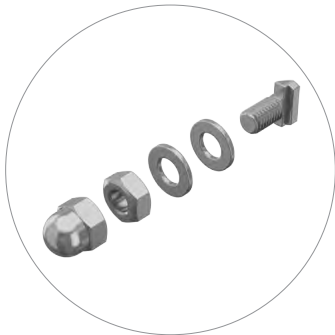

Hammerhead Screws
278
222

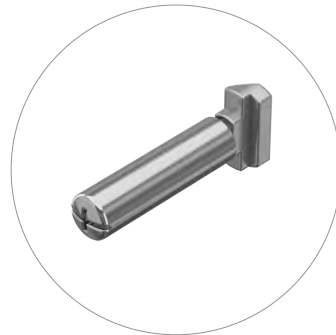

Shelf Support
279

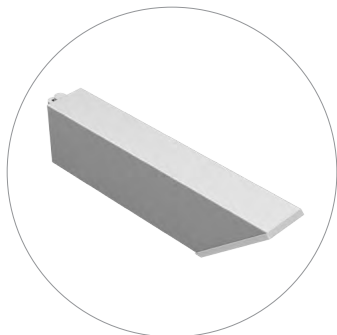

Shelf Brackets
284



Bracing parts
289



Fixing and Security Parts
291



Miscellaneous
300

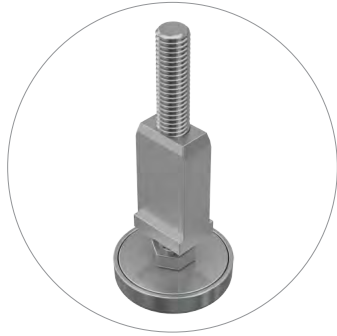

Adjustable feet and Castors
301



Base Plates
305

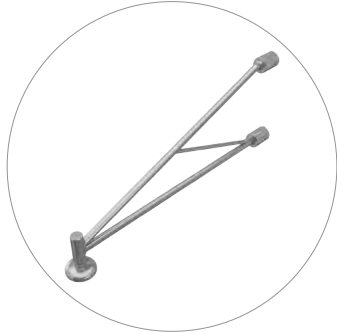

Support frames
311



Wardrobe Systems
313

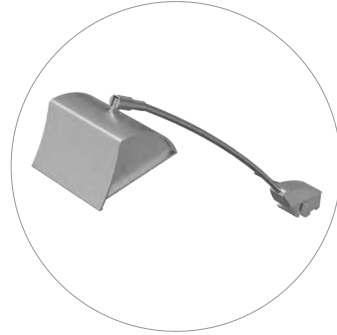

Electric
316



Monitor support systems
318

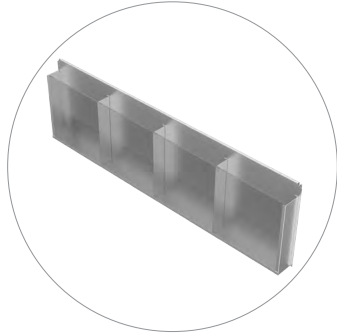

Literature Racks
321

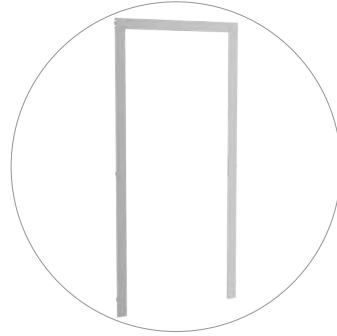

Standard Doors
326



Glass Doors
329

ACCESSORIES

TENSION LOCKS

TENSION LOCK, 13 MM

zinc die cast/steel
for all beam extrusions with lock chamber
21 x 12 mm
as well as in conjunction with adaptor
Z 161/A for beam extrusions with lock
chamber 39 x 12 mm
0.052 kg

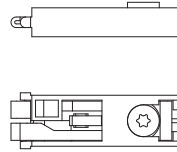

Z 961/13

STRAIGHT

Z 961/13.00

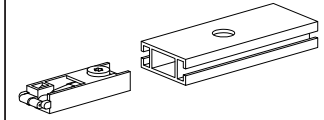

ADAPTOR FOR TENSION LOCK

plastic
for mounting tension locks Z 961/13 in
beam extrusions with lock chamber
39 x 12 mm
0.009 kg

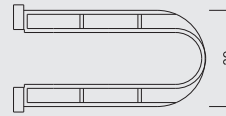
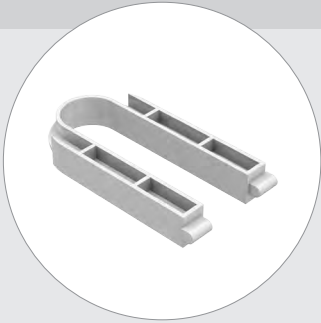

Z 161/A

Z 161/A.90

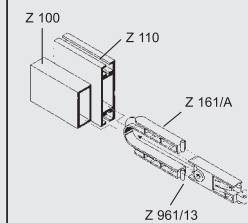

TENSION LOCK, 8 MM

zinc die cast/steel
for all extrusions with lock chamber
21 x 12 mm
0.054 kg

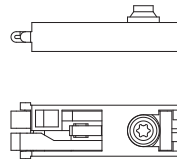

Z 961/8

Z 961/8.00

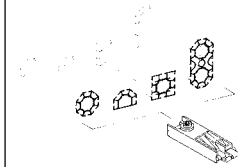

END CAP 13 MM DIA.

plastic, similar to RAL 7035

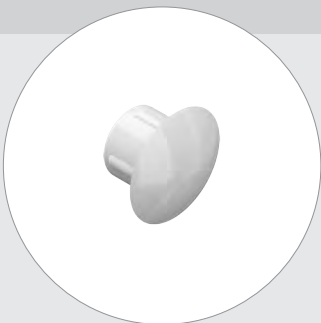

M 1491

M 1491.35

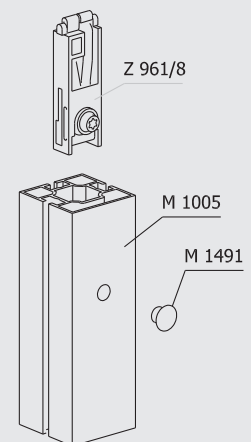

ACCESSORIES

TENSION LOCKS

TENSION LOCK, 13 MM

zinc die cast/steel
for all beam extrusions with lock chamber
21 x 12 mm
and **key hole aperture**
0.052 kg

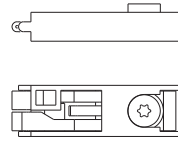

Z 951/13

Z 951/13.00

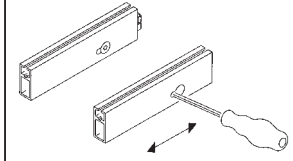

TENSION LOCK, 8 MM

zinc die cast/steel
for all upright-, round- and square
extrusions with lock chamber 21 x 12 mm
and **key hole aperture**
0.054 kg

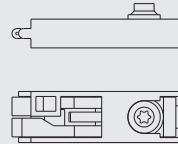
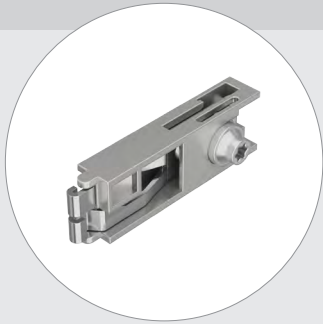

Z 951/8

Z 951/8.00

TENSION LOCK

steel
incl. countersunk screw E 111/m (M6)
for all beam extrusions with lock chamber
21 x 12 mm
0.057 kg

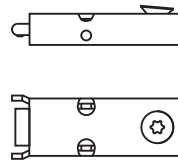

Z 962/T

Z 962/T.37

TENSION LOCK

zinc die cast/steel
for connecting beams with lock chamber
21x12 mm
to extrusions **M 1600, M 1606, M 1620,**
M 1622, M 1625, M 1629
0.054 kg



M 1609

M 1609.00

ACCESSORIES

TENSION LOCKS

TENSION LOCK

spring steel
incl. cylinder screw M6, hex-star T30
for all beam extrusions with lock chamber
21 x 12 mm
0.021 kg

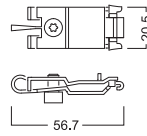

Z 960

STRAIGHT

Z 960.90

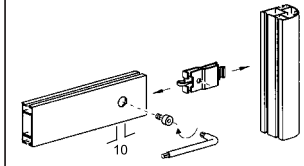

CURVED BEAM TENSION LOCK, 13 MM

zinc die cast/steel
for all curved beam extrusions with lock
chamber 21 x 12 mm
as well as in conjunction with
adaptor Z 161/A for beam extrusions
with lock chamber 39 x 12 mm
0.052 kg

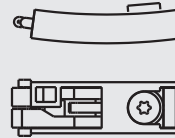

Z 962/13

CURVED

Z 962/13.00

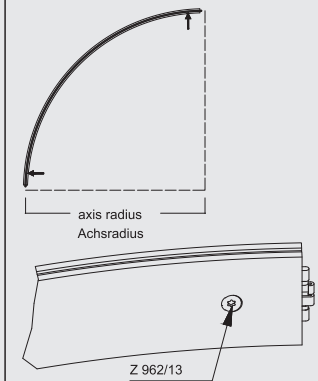

CURVED BEAM TENSION LOCK, 8 MM

zinc die cast/steel
for all curved upright, round and square
extrusions with lock chamber 21 x 12 mm
0.052 kg

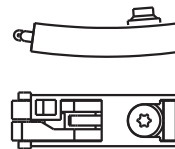

Z 962/8

Z 962/8.00

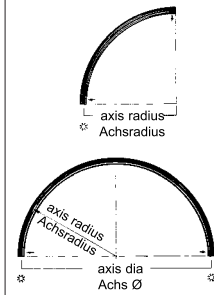

* = tension lock operation
+ = Spannschloss-Bedienung

ACCESSORIES

TENSION LOCKS

TENSION LOCK 22.5°

steel/aluminium
incl. countersunk screw E 111
for all beam extrusions with lock chamber
21 x 12 mm and miter cut 22.5°
0.044 kg

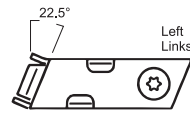

Z 953/L 22,5°

Z 953/L.37

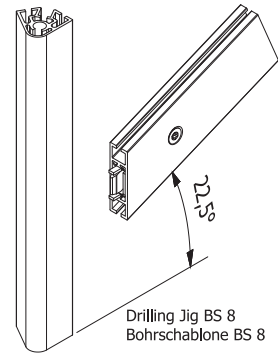

TENSION LOCK 22.5°

steel/aluminium
incl. countersunk screw E 111
for all beam extrusions with lock chamber
21 x 12 mm and miter cut 22.5°
0.044 kg

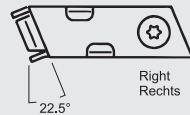

Z 953/R

Z 953/R.37

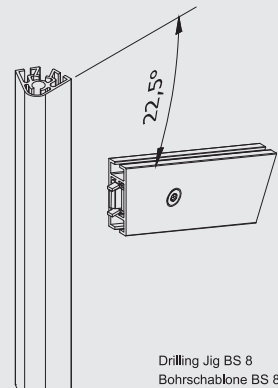

TENSION LOCK 22.5°

steel/aluminium
incl. countersunk screw E 111/20 and
adaptor Z 955
for all upright-, round- and square
extrusions with lock chamber 21 x 12 mm
and miter cut 22.5°
0.05 kg

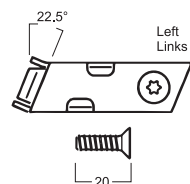

Z 953/20L

Z 953/20L.37

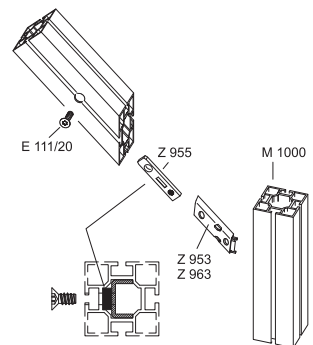

ACCESSORIES

TENSION LOCKS

TENSION LOCK 22.5°

steel/aluminium
incl. countersunk screw **E 111/20** and
adaptor Z 955
for all upright-, round- and square
extrusions with lock chamber 21 x 12 mm
and miter cut 22.5°
0.05 kg

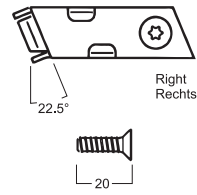

Z 953/20R 22,5°

Z 953/20R.37

TENSION LOCK 45°

steel/aluminium
incl. countersunk screw **E 111**
for all beam extrusions with lock chamber
21 x 12 mm and miter cut 45°
0.056 kg

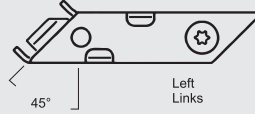

Z 963/L 45°

Z 963/L.37

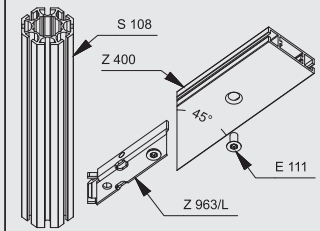

TENSION LOCK 45°

steel/aluminium
incl. countersunk screw **E 111**
for all beam extrusions with lock chamber
21 x 12 mm and miter cut 45°
0.056 kg

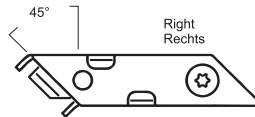

Z 963/R

Z 963/R.37

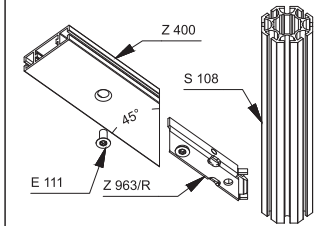

TENSION LOCK 45°

steel/aluminium
incl. countersunk screw **E 111/20** and
adaptor Z 955
for all upright-, round- and square
extrusions with lock chamber 21 x 12 mm
and miter cut 22.5°
0.066 kg

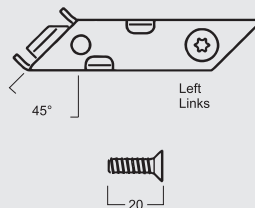

Z 963/20L

Z 963/20L.37

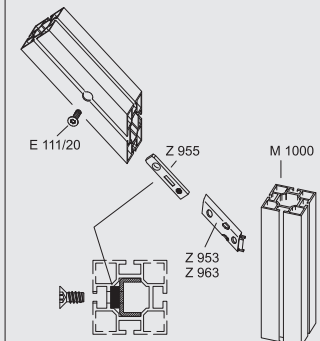

ACCESSORIES

TENSION LOCKS

TENSION LOCK 45°

steel/aluminium
incl. countersunk screw E 111/20 and
adaptor Z 955
for all upright-, round- and square
extrusions with lock chamber 21 x 12 mm
and miter cut 22.5°
0.066 kg

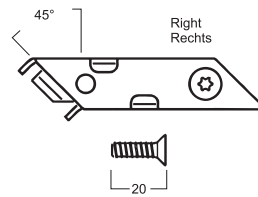

Z 963/20R

Z 963/20R.37

CLAMPING ELEMENT

steel
for all beam extrusions with lock chambers
21 x 12 mm
operating through system groove
0.092 kg

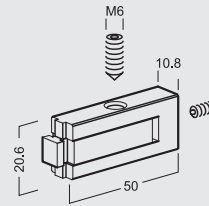

Z 940

CLAMPING ELEMENTS

Z 940.37

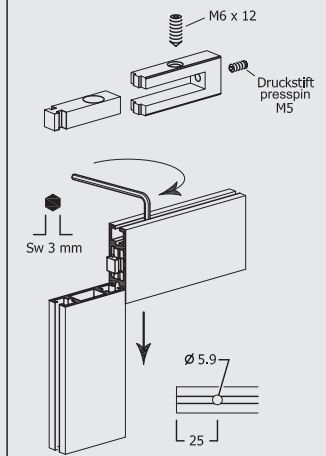

CLAMPING ELEMENT

steel
variable in angle, max. 15°
for all beam extrusions with lock chamber
21 x 12 mm
0.066 kg

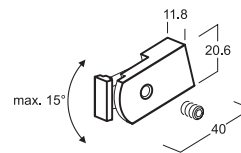

Z 942

Z 942.37

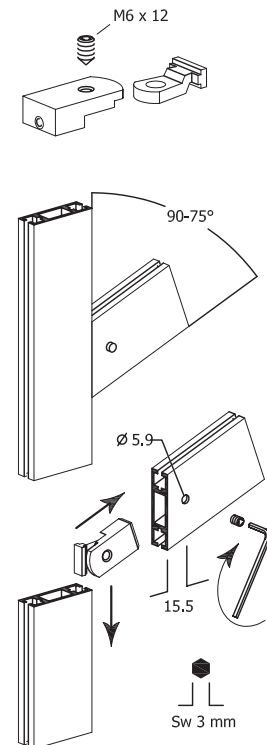

TENSION LOCKS

CLAMPING ELEMENT

steel/plastic
variable in angle, max. 15°
 for all extrusions with lock chamber
 21 x 12 mm
 0.073 kg

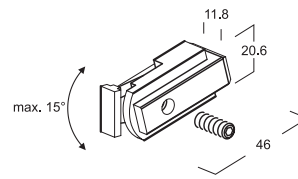

Z 943

CLAMPING ELEMENTS

Z 943.37

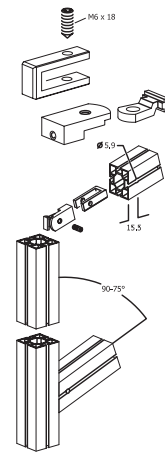

ACCESSORIES

GLASS AND PANEL RETAINER

GLASS RETAINER, SINGLE

steel, zinc-plated/stainless steel
incl. mounting parts M 1379, M 1388,
M 1389
left hand version
for system groove 4.3 mm
0.277 kg

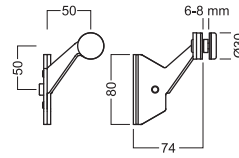

M 1385

M 1385.90

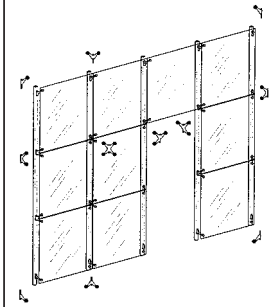

GLASS RETAINER, SINGLE

steel, zinc-plated/stainless steel
incl. mounting parts M 1379, M 1388,
M 1389
right hand version
for system groove 4.3 mm
0.277 kg

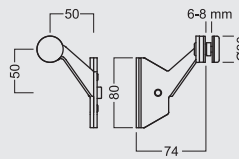

M 1386

M 1386.90

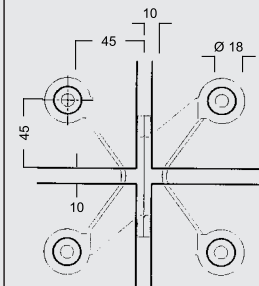

GLASS RETAINER, 2 WAY

steel, zinc-plated/stainless steel
incl. mounting parts M 1379, M 1388,
M 1389
for horizontal use
for system groove 4.3 mm
0.4 kg

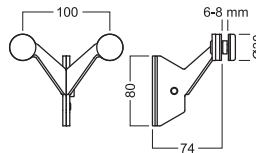

M 1380

M 1380.90

Outer corner:
Außenecke:

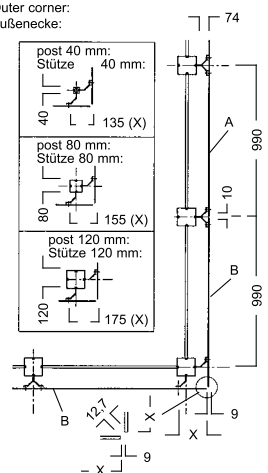

ACCESSORIES

GLASS AND PANEL RETAINER

GLASS RETAINER, 2 WAY

steel, zinc-plated/stainless steel
incl. mounting parts M 1379, M 1388,
M 1389
for vertical use
for system groove 4.3 mm
0.396 kg

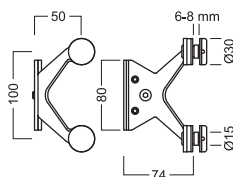

M 1381

M 1381.90

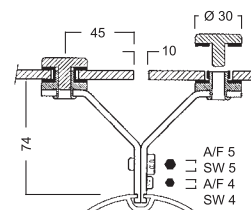

GLASS RETAINER, 3 WAY

steel, zinc-plated/stainless steel
incl. mounting parts M 1379, M 1388,
M 1389
left hand version
for system groove 4.3 mm
0.522 kg

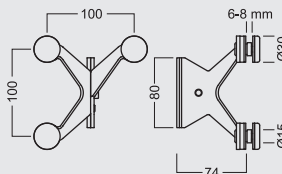

M 1375

M 1375.90

GLASS RETAINER, 3 WAY

steel, zinc-plated/stainless steel
incl. mounting parts M 1379, M 1388,
M 1389
right hand version
for system groove 4.3 mm
0.547 kg

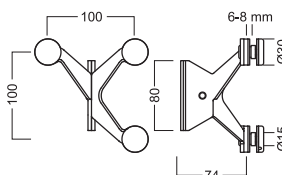

M 1376

M 1376.90

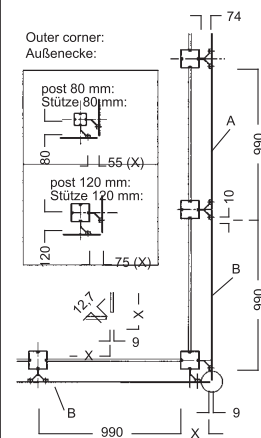

GLASS RETAINER, 4 WAY

steel, zinc-plated/stainless steel
incl. mounting parts M 1379, M 1388,
M 1389
for system groove 4.3 mm
0.638 kg

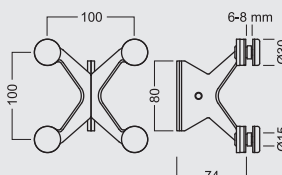
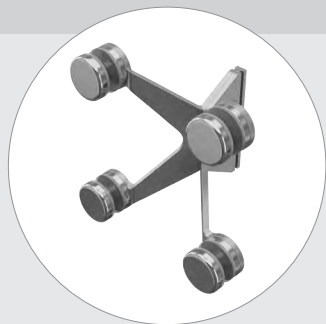

M 1370

M 1370.90

ACCESSORIES

GLASS AND PANEL RETAINER

END SCREW

stainless steel
30 mm dia.
for panel thickness 10 - 16 mm
0.038 kg

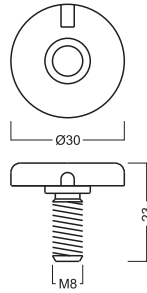

M 1387

M 1387.44

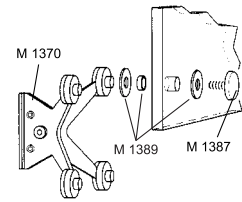

GLASS PANEL RETAINER "SINGLE"

steel, matt chrome-plated/stainless steel
with hammerhead screw M 1470/Ha (M9)
for mounting to system groove 4.3 mm
incl. mounting parts M 1388 and M 1389
for panel thickness 6 - 8 mm
assembly without tools
0.201 kg

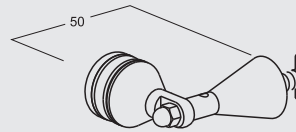

M 1395

M 1395.90

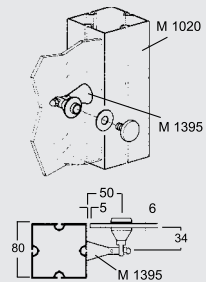

GLASS PANEL RETAINER "DOUBLE"

steel, matt chrome-plated/stainless steel
with hammerhead screw M 1470/Ha (M8)
for mounting to system groove 4.3 mm
incl. mounting parts M 1388 and M 1389
for panel thickness 6 - 8 mm
assembly without tools
0.298 kg

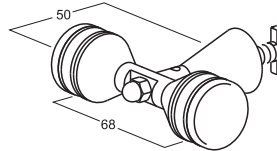

M 1396

M 1396.90

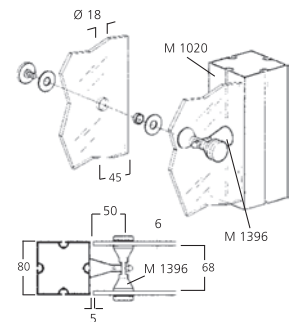

GLASS PANEL RETAINER "DOUBLE"

steel, matt chrome-plated/stainless steel
with hammerhead screw M 1470/Ha (M8)
for mounting to system groove 4.3 mm
incl. mounting parts M 1388 and M 1389
for panel thickness 6 - 8 mm
assembly without tools
0.343 kg

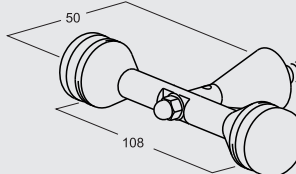

M 1397

M 1397.90

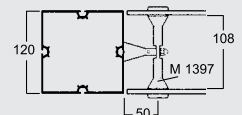

ACCESSORIES

GLASS AND PANEL RETAINER

PANEL RETAINER

steel, zinc plated/stainless steel
incl. rubber inserts and
hammerhead screw M 1470/Ha (M8)
**for 5 - 6 mm glass or max. 10 mm
panels**
assembly without tools
0.076 kg

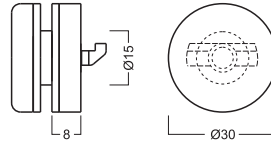

M 1391

M 1391.90

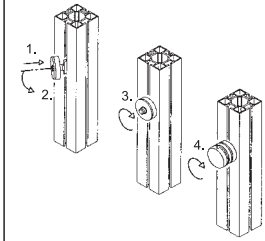

PANEL RETAINER

steel, zinc plated/stainless steel
incl. rubber inserts and hammerhead screw
M 1475/Ha (M8)
**for 8 - 10 mm glass or max. 14 mm
panels**
assembly without tools
0.078 kg

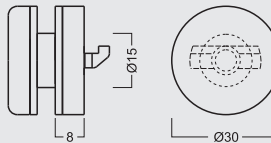

M 1392

M 1392.90

ACCESSORIES

GLASS AND PANEL RETAINER

GLASS RETAINER

steel
for glass thickness 6 - 8 mm
 in connection with round tube M 1140,
 M 1389 and M 1388
for panel thickness 10 - 16 mm
 in connection with round tube M 1140 and
 M 1387
 0.075 kg

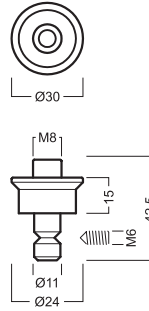

M 1393

M 1393.39

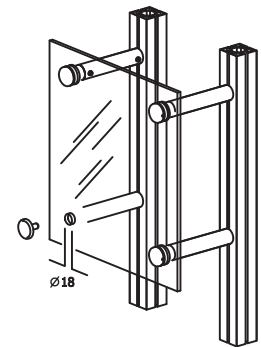
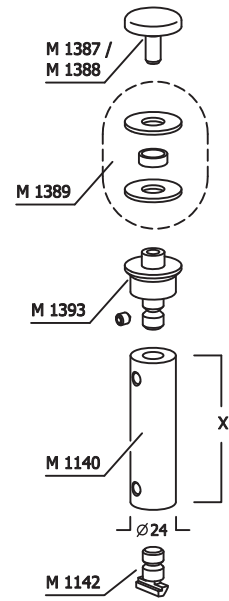

GLASS RETAINER 180°

steel, zinc-plated/stainless steel
 incl. mounting parts M 1388, M 1389
for panel thickness 6 - 8 mm
 0.215 kg

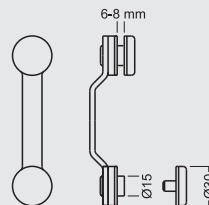

M 1382

M 1382.90

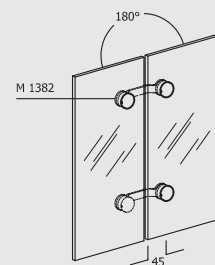

ACCESSORIES

GLASS AND PANEL RETAINER

GLASS RETAINER 90°

steel, zinc-plated/stainless steel
incl. mounting parts M 1388, M 1389
for panel thickness 6 - 8 mm
0.198 kg

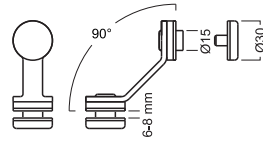

M 1383

M 1383.90

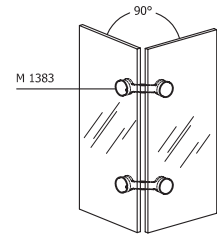

GLASS RETAINER 135°

steel, zinc-plated/stainless steel
incl. mounting parts M 1388, M 1389
for panel thickness 6 - 8 mm
0.205 kg

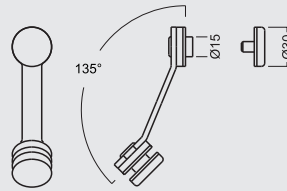
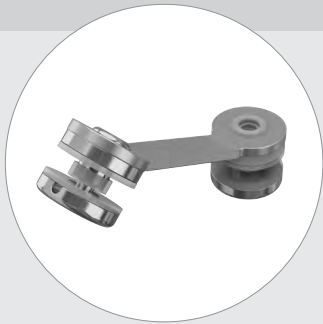

M 1384

M 1384.90

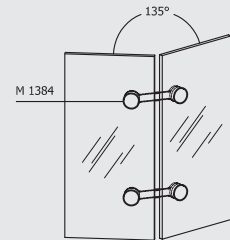

FIXING ANGLE

steel
for glass retainers M 1370, M 1375,
M 1376, M 1380, M 1381, M 1385,
M 1391, M 1392
0.034 kg

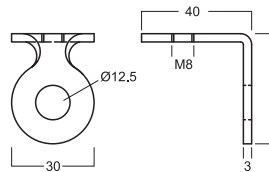

M 1390

M 1390.37

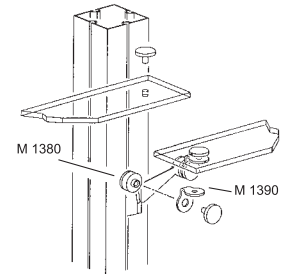

GLASS RETAINER

zinc die cast
with hammerhead screw M 1470/Ha (M8)
for mounting to system groove 4.3 mm
for glass thickness 8 mm
0.168 kg

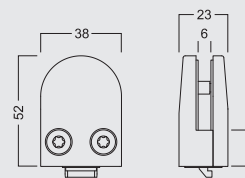

M 1445

M 1445.39

ACCESSORIES

GLASS AND PANEL RETAINER

GLASS RETAINER

zinc die cast
with adjustable foot M 1446/1
for glass thickness 8 mm
0.352 kg

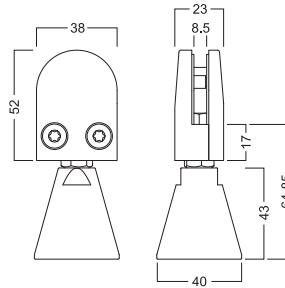

M 1446

M 1446.39

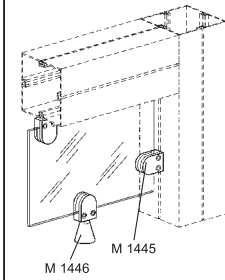

GLASS RETAINER

zinc die cast
with hammerhead screw M 1470/Ha (M8)
for mounting to system groove 4.3 mm
for glass thickness 10 mm
0.271 kg

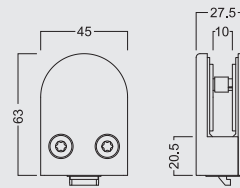

M 1447

M 1447.39

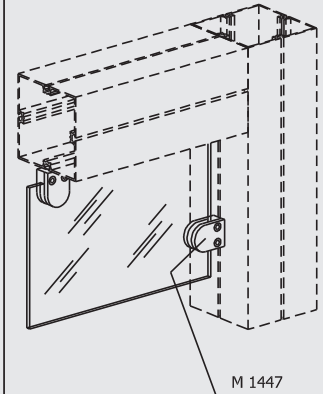

GLASS RETAINER

zinc die cast
with hammerhead screw M 1470/Ha (M8)
for mounting to system groove 4.3 mm
for glass thickness 12 mm
0.263 kg

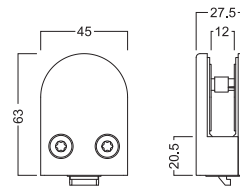

M 1467

M 1467.39

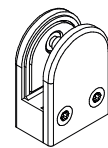

GLAS RETAINER

zinc die cast
with hammerhead screw M 1470/Ha (M8)
for mounting to system groove 4.3 mm
for glass thickness 13.5 mm
0.459 kg

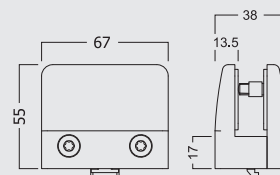

M 1492

M 1492.39

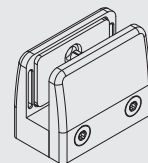

ACCESSORIES

GLASS AND PANEL RETAINER

PANEL RETAINER

steel
with hammerhead screw for mounting to
system groove 4.3 mm
for panel thickness max. 8 mm
0.119 kg

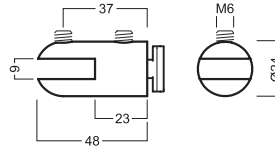

M 1456

M 1456.39

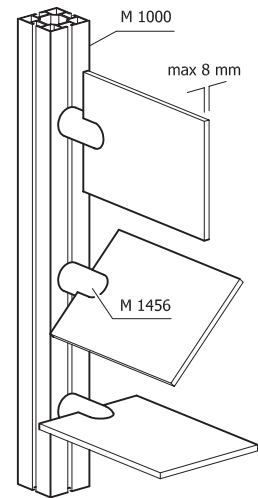

PANEL RETAINER WITH SLOT

steel
incl. 1 hammer-head bolt M 1142
and 1 set screw M6x8
for mounting to system groove 4.3 mm
for 2 - 4 mm thick panels
maximum load 65 kg
0.354 kg

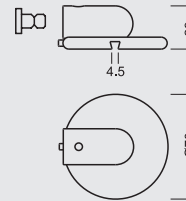

M 1580

M 1580.21

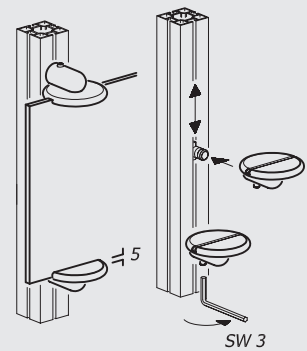

3-WAY PANEL RETAINER

steel
incl. 1 hammerhead bolt M 1145 and
3 panel clips M 1344
for fixing to system groove 4,3 mm
assembly without tools
for panel thickness 3 - 4 mm
0.258 kg

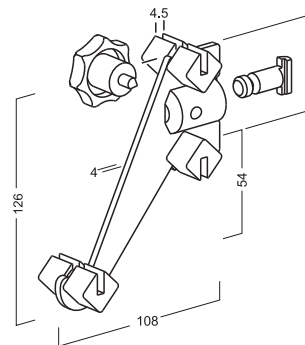

M 1341

M 1341.21

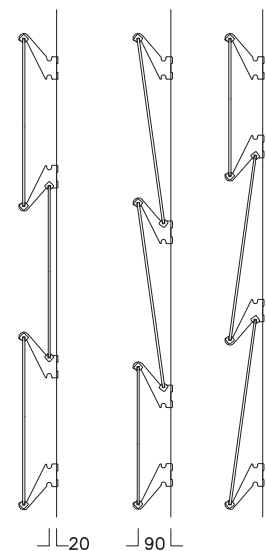

ACCESSORIES

GLASS AND PANEL RETAINER

PANEL CLIP

plastic
for panel retainer M 1341
for panel thickness 3 - 4 mm
0.011 kg

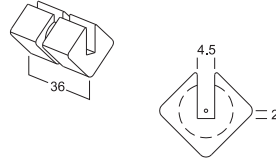

M 1344

M 1344.35

3-WAY PANEL RETAINER

steel
incl. hammerhead bolt M 1145 and
3 panel clips M 1346
for fixing to system groove 4.3mm
assembly without tools
for panel thickness 5 - 6 mm
0.258 kg

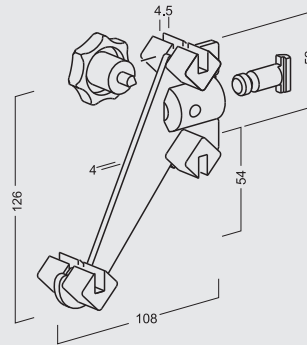

M 1343

M 1343.21

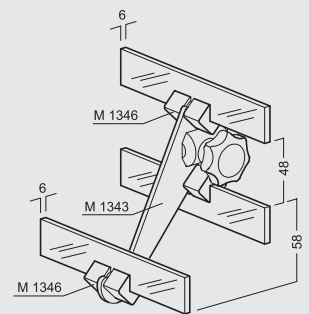

PANEL CLIP

plastic
for panel retainer M 1343
for panel thickness 5 - 6 mm
0.011 kg

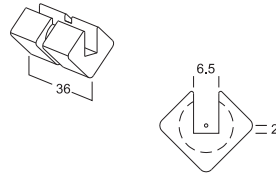

M 1346

M 1346.35

GRAPHIC PANEL RETAINER

aluminium
incl. built-in tension lock Z 961/13 and
insert E 272
**for panel thickness from
2 mm to 22 mm**
for upper, lower, right hand and
left hand use
maximum load 35 kg
0.158 kg

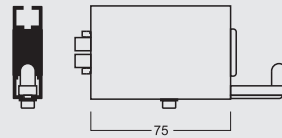

E 271

E 271.11

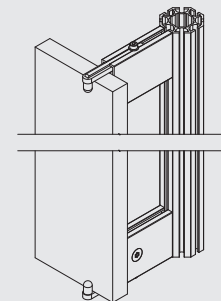

ACCESSORIES

GLASS AND PANEL RETAINER

GRAPHIC PANEL RETAINER

aluminium
incl. built-in tension lock Z 961/13 and
2 inserts E 272
**for panel thickness from
2 mm to 22 mm**
for upper, lower, right hand and
left hand use
for internal corner solution
maximum load 35 kg
0.293 kg

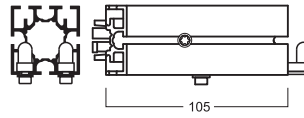

E 273

E 273.11

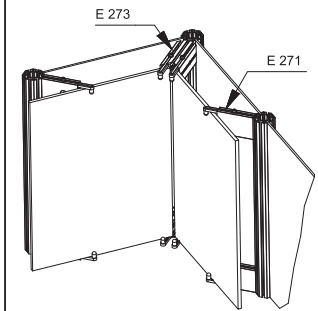

INSERT PIECE

zinc die cast
for graphic panel retainer E 271 and E 273
0.029 kg



E 272

E 272.39

FASCIA HOOK

steel
with 2 countersunk drill holes 5 mm dia.
0.023 kg

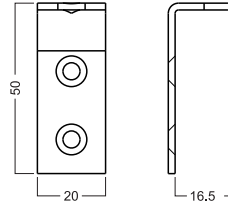

E 220

E 220.38

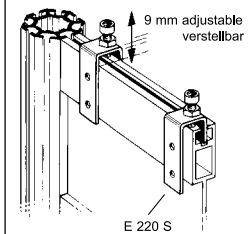

FASCIA HOOK

steel
with 2 countersunk drill holes 5 mm dia.
adjustable height 9 mm
0.029 kg

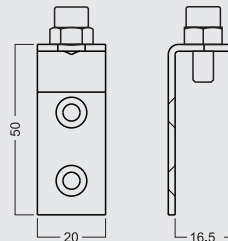

E 220/S

E 220/S.38

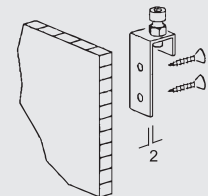

ACCESSORIES

GLASS AND PANEL RETAINER

FASCIA HOOK

steel
with 2 countersunk drill holes $\varnothing 5$ mm
0.031 kg

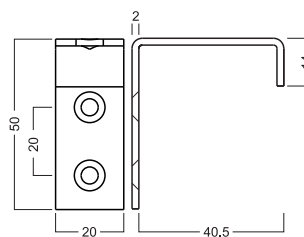
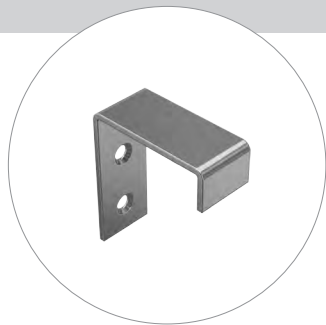

M 1050

M 1050.38

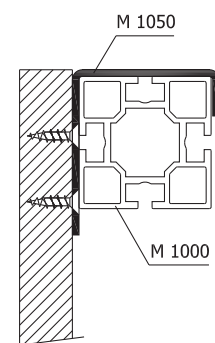

ACCESSORIES

GLASS AND PANEL EXTRUSIONS

INSERT EXTRUSION

aluminium
with 1 system groove 4.3 mm
for wooden panels
5000 mm long
1.05 kg

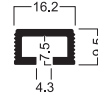

W 416

W 416.01

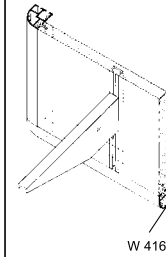

W 416

PANEL RETAINER, TOP

aluminium
incl. 5 pressure screws M 1366/20 (M4)
for insertion of 16 mm wall panels
5000 mm long
2.379 kg

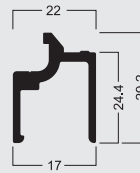

M 1366

M 1366.01

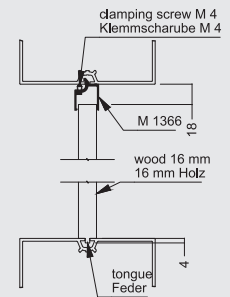

WALL INSERT EXTRUSION

aluminium
incl. 6 set screws S 204/20 (M4)
for all extrusion with system groove 4.3 mm
5000 mm long
2.98 kg

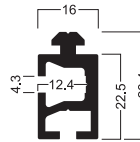

S 204

S 204.01

SUPPORTING EDGE

plastic, semi-hard
5000 mm long
0.4 kg

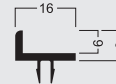

E 442

E 442.30
E 442.33
E 442.35

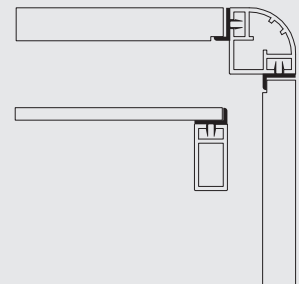

ACCESSORIES

GLASS AND PANEL EXTRUSIONS

GLASS RETAINER

plastic, semi-hard
for glass thickness 6 mm
 5000 mm long
 0.65 kg

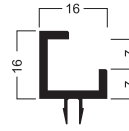

E 443

E 443.35

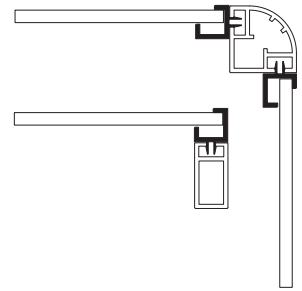

PANEL RETAINER EXTRUSION

plastic, semi-hard
 to retain 3-4 mm panels,
 applicable for all 16 mm extrusions
 5000 mm lang
 0.65 kg

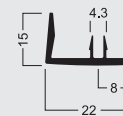

E 428

E 428.30

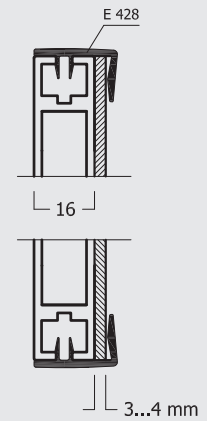

GLASS PANEL RETAINER

plastic, hard/soft
for 4 - 8 mm panels
 5000 mm long
 0.83 kg

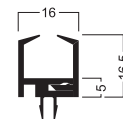

E 420

E 420.30
 E 420.33
 E 420.35

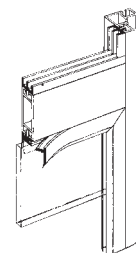

GLASS PANEL RETAINER

plastic, hard/soft
for 4 - 6 mm panels
 5000 mm long
 0.45 kg

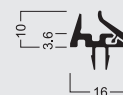

E 424

E 424.30
 E 424.35



ACCESSORIES

GLASS AND PANEL EXTRUSIONS

GLASS PANEL RETAINER

plastic, semi-hard
for 6 mm panels
 5000 mm long
 0.41 kg

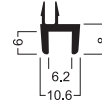

E 421

E 421.30
 E 421.33
 E 421.35

GLASS PANEL RETAINER

plastic, semi-hard
for 8 mm panels
 5000 mm long
 0.45 kg

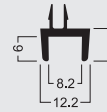

E 422

E 422.35

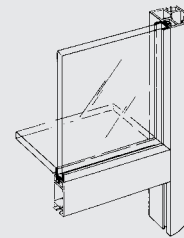

DOOR STOPPING EXTRUSION

plastic, semi-hard
 with soft rubber lip insert
 for hinged wooden or glass doors
 5000 mm long
 0.37 kg

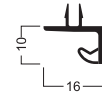

E 430

E 430.30
 E 430.33
 E 430.35

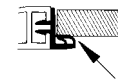

ACCESSORIES

GLASS AND PANEL EXTRUSIONS

DOOR STOPPING EXTRUSION

plastic, semi-hard
with soft rubber lip insert for hinged
wooden or glass doors
only for extrusions M 1618, Z 305, Z 306
5000 mm long
0.315 kg



E 433

E 433.35

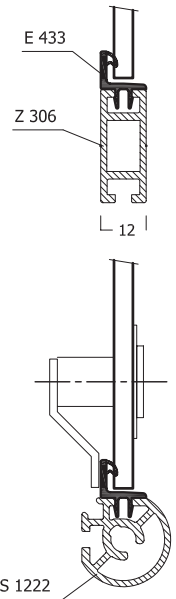

GLASS FRAME EXTRUSION

plastic, semi-hard
also useable as door stopper extrusion in
combination with E 441
5000 mm long
0.47 kg

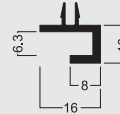

E 440

E 440.30
E 440.33
E 440.35

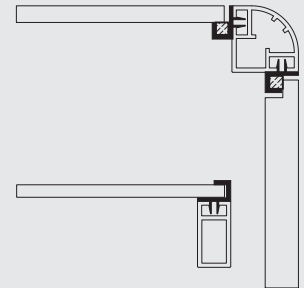

RUBBER SPONGE BUMPER

rubber
for use with E 440 only
for glass support and door stop
5000 mm long
1 kg



E 441

E 441.35

ACCESSORIES

GLASS AND PANEL EXTRUSIONS

ANTI-RATTLE STRIP

rubber
for mounting glass in the system groove
glass thickness 4 mm
insertable in all hollow chambers
from 5.4 x 12 mm
50000 mm long
2 kg



E 444

E 444.33

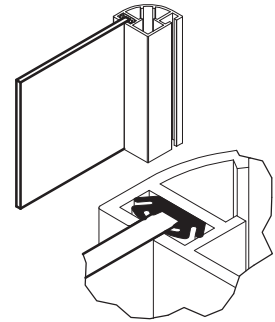

ANTI-RATTLE STRIP

rubber
for mounting glass in the system groove
glass thickness 4 mm
insertable in extrusions S 1129, S 1303 and
S 1310
50000 mm long
3.5 kg



E 445

E 445.33

ANTI-RATTLE STRIP

silicone
for mounting glass in the system groove
glass thickness 4 mm
insertable in extrusions M 1620, M 1622,
M 1625, M 1629
25000 mm long
0.4 kg



M 1643

M 1643.51

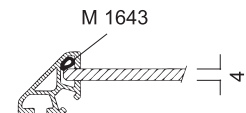

ANTI-RATTLE STRIP

silicone
for mounting glass in the system groove
glass thickness 4 mm
insertable in extrusions M 1600, M 1606
50000 mm long
1.15 kg



M 1644

M 1644.51



ACCESSORIES

COVER AND CABLE RETAINER EXTRUSIONS

GROOVE FILLER

plastic, semi-hard
for system groove 4.3 mm
5000 mm long
0.12 kg



E 455

E 455.30
E 455.33
E 455.35

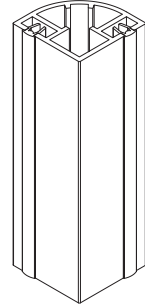

COVER EXTRUSION

plastic, semi-hard
for system groove 4.3 mm
5000 mm long
0.38 kg



E 458

E 458.35

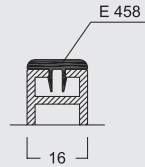

COVER EXTRUSION

aluminium
incl. 10 plastic clips E 470/C
(2 pcs/rm recommended)
for all 40 mm extrusions with straight
connection face
to cover the system groove
5000 mm
1.35 kg



W 910

W 910.01

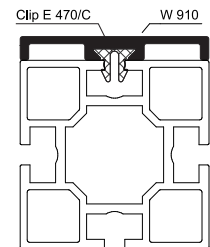

COVER EXTRUSION

aluminium
incl. 10 plastic clips E 470/C
(2 pcs/rm recommended)
for all 60 mm extrusions with straight
connection face
to cover the system groove
5000 mm
1.76 kg

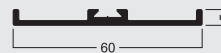

W 810

W 810.01

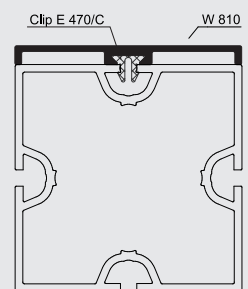

ACCESSORIES

COVER AND CABLE RETAINER EXTRUSIONS

COVER EXTRUSION

aluminium
incl. 10 plastic clips E 470/C
(2 pcs/rm recommended)
for all 80 mm extrusions with straight
connection face
to cover the system groove
5000 mm long
2.15 kg

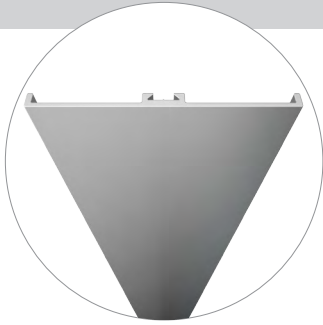

M 1044

M 1044.01

COVER EXTRUSION

aluminium
can be powder-coated or film laminated
with slide-on technique
for all extrusions **80 mm**
5000 mm long
2.12 kg



M 1367

M 1367.00

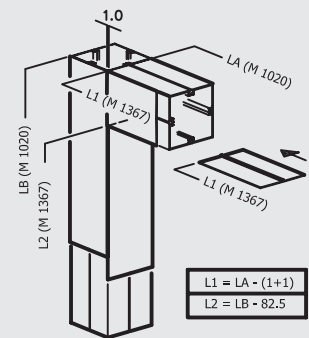
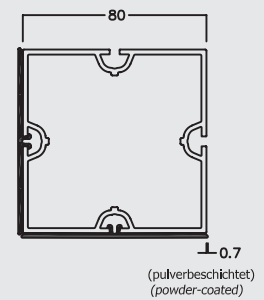

COVER EXTRUSION

aluminium
can be powder-coated or film laminated
with slide-on technique for all extrusions
120 mm
5000 mm long
3.1 kg

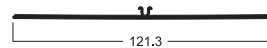
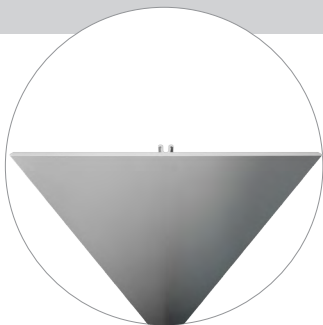

M 1368

M 1368.00

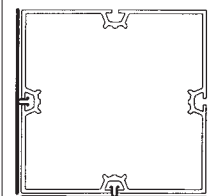

0,7
(pulver-coated)
(pulverbeschichtet)

ACCESSORIES

COVER AND CABLE RETAINER EXTRUSIONS

ELLIPTICAL COVER EXTRUSION 40 MM

aluminium
5000 mm long
2.15 kg

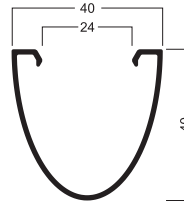

M 1483

M 1483.01

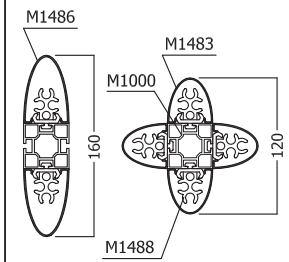

END PLATE

steel
for elliptical cover extrusion M 1483
0.038 kg

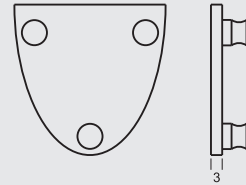

M 1493

M 1493.21

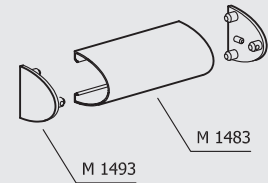

ELLIPTICAL COVER EXTRUSION 60 MM

aluminium
5000 mm long
3.05 kg

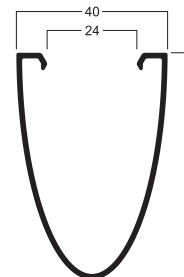

M 1486

M 1486.01

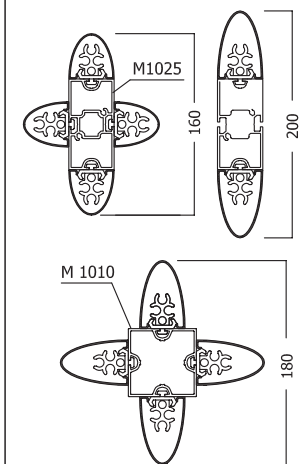

END PLATE

steel
for elliptical cover extrusion M 1486
0.051 kg

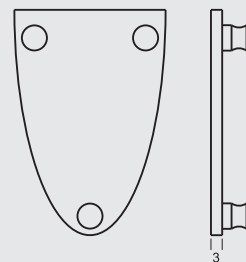

M 1495

M 1495.21

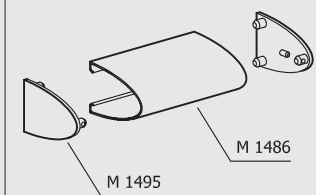

ACCESSORIES

COVER AND CABLE RETAINER EXTRUSIONS

CABLE RETAINING CLIP

plastic
for mounting cover extrusions M 1483 and
M 1486 to system groove 4.3 mm
**electric cables can be fixed at the same
time**
0.003 kg

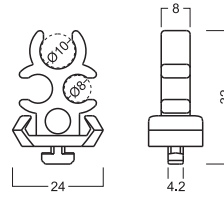

M 1488

M 1488.35

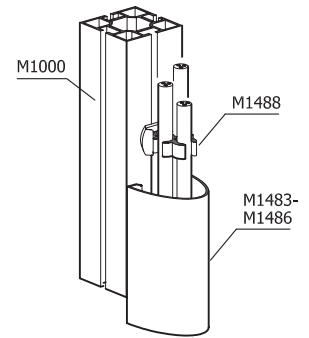

CLIP

plastic
for mounting cover extrusions M 1483 and
M 1486 to system groove 4.3 mm
0.002 kg



M 1489

M 1489.35

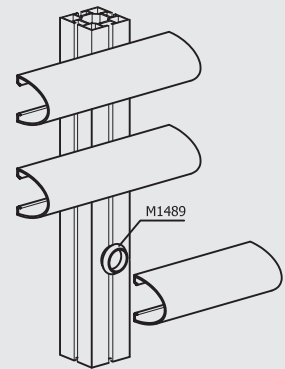

CABLE CLAMP

plastic
for system groove 4.3 mm



E 245

E 245.30

CABLE RETAINING EXTRUSION

plastic, semi-hard,
5000 mm long
0.73 kg



E 460

E 460.30
E 460.35

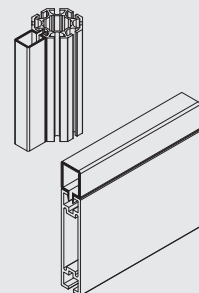

ACCESSORIES

COVER AND CABLE RETAINER EXTRUSIONS

CABLE RETAINING EXTRUSION

plastic, semi-hard
5000 mm long
1.195 kg

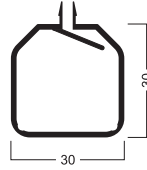

E 463

E 463.35

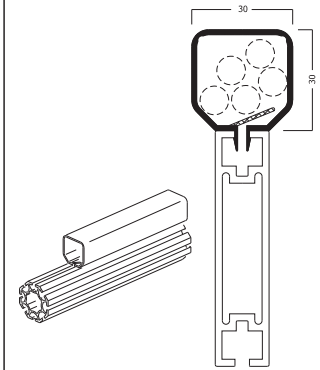

CABLE RETAINING EXTRUSION

aluminium
incl. 5 plastic clips E 470/C
cover extrusion with snap effect
for mounting to system groove 4.3 mm
2480 mm long
1.112 kg

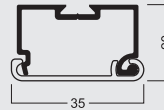
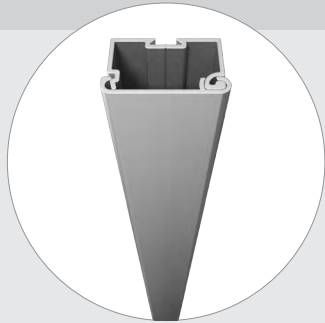

M 1485

M 1485.01



ACCESSORIES

EDGE PROTECTION EXTRUSIONS

EDGE PROTECTION

aluminum
5000 mm long
0.605 kg

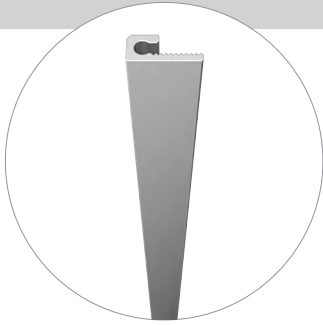

A 200

A 200.01

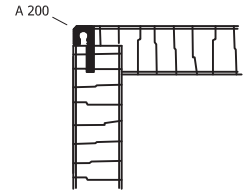

KNUCKLE JOINT

zinc die cast
connects 2 edge protector extrusions A 200
0.008 kg

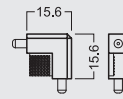
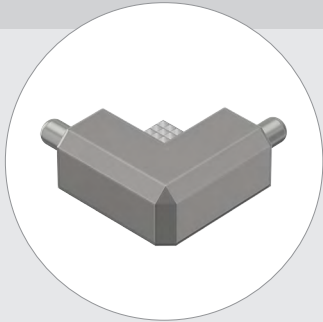

A 220

A 220.39

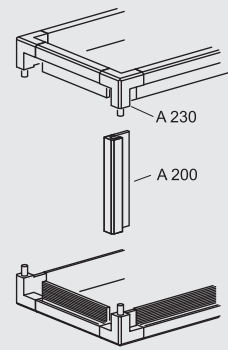

KNUCKLE JOINT

zinc die cast
connects 3 edge protector extrusions A 200
0.01 kg

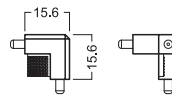
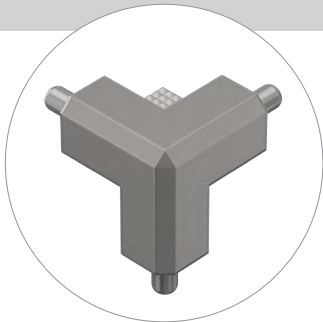

A 230

A 230.39

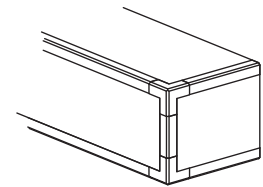

ACCESSORIES

CONNECTOR EXTRUSIONS

EXTRUSION CONNECTOR

plastic, semi-hard
for connection of 2 aluminium extrusions in
parallel alignment
dimension 8.5 mm
suitable for extrusions with a
narrow mounting chamber (8.7 mm min.)
5000 mm long
0.277 kg



E 438

E 438.30

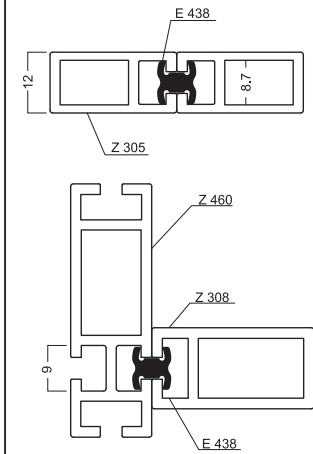

EXTRUSION CONNECTOR

plastic, semi-hard
for connection of 2 aluminium extrusions in
parallel alignment
5000 mm long
0.35 kg



E 450

E 450.30

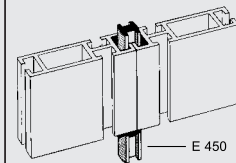

EXTRUSION CONNECTOR

plastic, semi-hard,
for wooden panels from 13 mm up
used for extrusions with system groove
depth of at least 7.5 mm
5000 mm long
0.35 kg



E 451

E 451.35

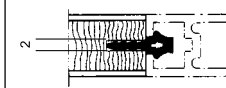

EXTRUSION CONNECTOR

plastic, semi-hard
for wooden panels from 13 mm up
to clip into system groove
5000 mm long
0.23 kg



E 452

E 452.35

7

ACCESSORIES

CONNECTORS

DISTANCE PIECE

steel
incl. 2 hammerhead bolts M 1142
for system groove 4.3 mm
0.077 kg

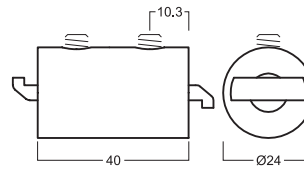

M 1146

M 1146.01

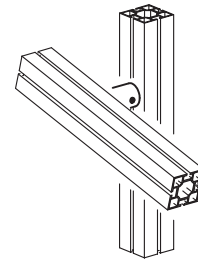

HINGED SET

steel
incl. 2 hammerhead bolts M 1142
for mounting to system groove 4.3 mm
0.237 kg

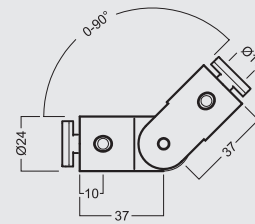

M 1457

M 1457.39

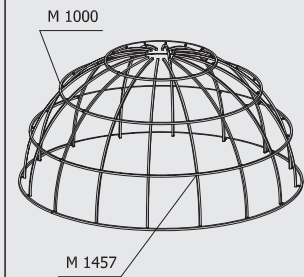

CONNECTOR

aluminium
beam extrusion Z 402
incl. 2 built-in tension locks Z 961/13
to be used as shortest connection element
between two uprights
0.16 kg

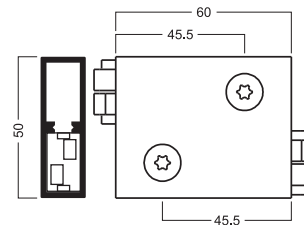

Z 910

Z 910.01

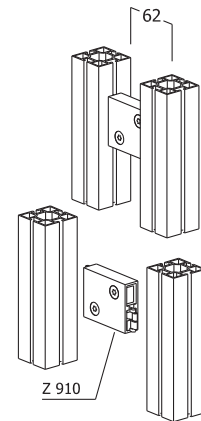

ACCESSORIES

CONNECTORS

CONNECTOR

aluminium
rectangular extrusion M 1091
incl. 2 built-in tension locks Z 961/8
to be used as shortest connection element
between two uprights
0.266 kg

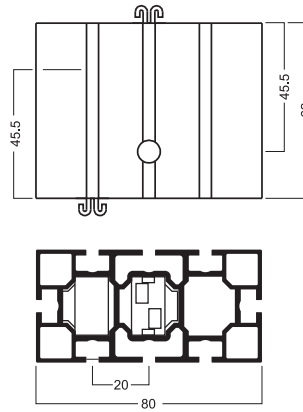

Z 915

Z 915.01

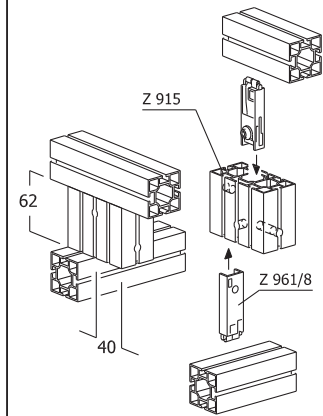

INTERNAL CONNECTOR

aluminium
incl. 2 countersunk screws E111/m (M6)
for quarter-round, square and triangular
extrusions 32 mm
0.043 kg

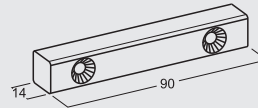

S 1155

S 1155.00

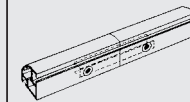

INTERNAL CONNECTOR STRAIGHT

aluminium
incl. 1 set screw Z 967/20 (M6),
2 countersunk screws E 111/m (M6)
2 countersunk screws M 1102/20 (M6)
and 2 washers Z 185
for extrusions with lock chamber
21 x 12 mm
0.128 kg

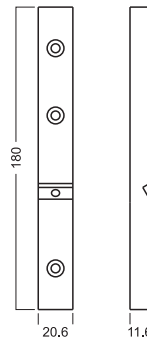

Z 967

Z 967.00

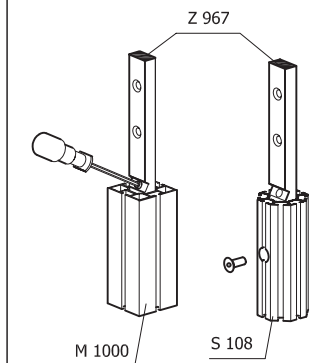

WASHER

aluminium
for 13 mm hole in combination with
countersunk screw E 111



Z 185

Z 185.01

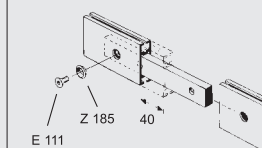

ACCESSORIES

CONNECTORS

INTERNAL CONNECTOR STRAIGHT

aluminium/spring steel
with push button setting for assembly without tools
 for all beam extrusions with lock chamber
 21 x 12 mm and hole 13 mm dia.
 0.106 kg

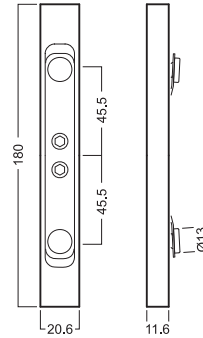

Z 977

Z 977.90

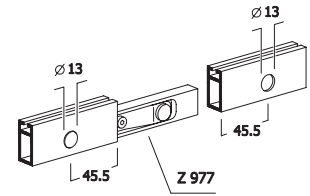

INTERNAL CONNECTOR STRAIGHT

aluminium/spring steel
with push button setting for assembly without tools
 for vertical connection of upright extrusions
 with octangular chamber and
 holes 8 mm dia.
 0.174 kg

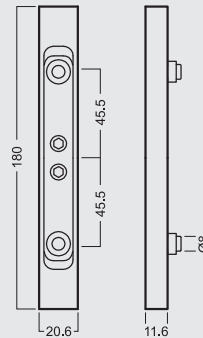

Z 978

Z 978.90

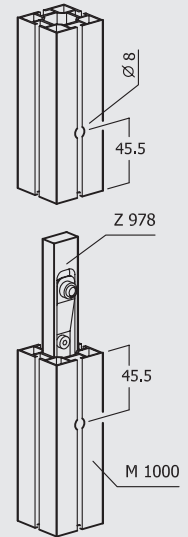

INTERNAL CONNECTOR

aluminium
 incl. 2 countersunk screws E 111
 and 2 washers Z 185
for beam extrusions with lock chamber
39 x 12 mm
 0.211 kg

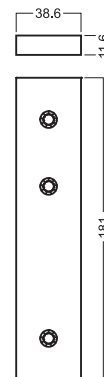

Z 167

Z 167.00

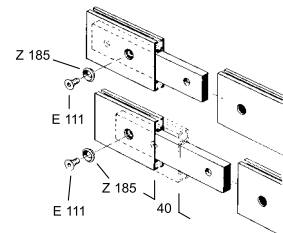

ACCESSORIES

CONNECTORS

EXTRUSION CONNECTOR

aluminium
for use as extrusion extension piece
for all square and round extrusions **60 mm**
5000 mm long
3.264 kg

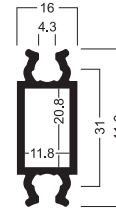

M 1205

M 1205.00

INTERNAL CONNECTOR STRAIGHT

aluminium
incl. 4 countersunk screws M 1064/20 (M5)
for all square and round extrusions **60 mm**
with length up to 999 mm
for vertical or horizontal use
320 mm long
0.308 kg

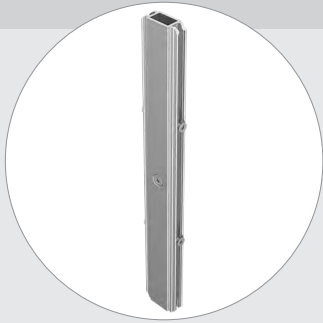

M 1064

M 1064.01

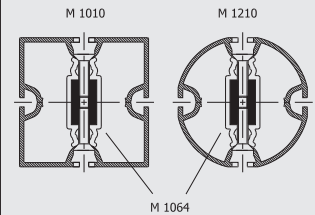

EXTRUSION CONNECTOR

aluminium
for use as extrusion extension piece
for all square and round extrusions **80 mm**
5000 mm long
5.52 kg

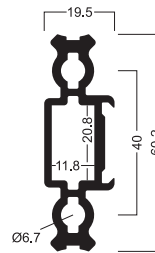

M 1230

M 1230.00

INTERNAL CONNECTOR STRAIGHT

aluminium
incl. 8 countersunk screws M 1100/20 (M5)
for all square and round extrusions **80 mm**
with a length up to 999 mm
for vertical and horizontal use
320 mm long
0.402 kg

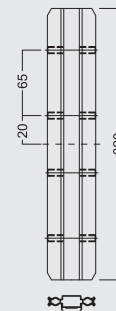
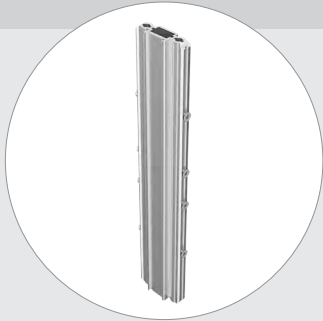

M 1121

M 1121.00



ACCESSORIES

CONNECTORS

INTERNAL CONNECTOR STRAIGHT

aluminium
incl. 8 countersunk screws M 1100/20
for all square and round extrusions **80 mm**
with a length from 1000 - 3000 mm
480 mm long
0.568 kg

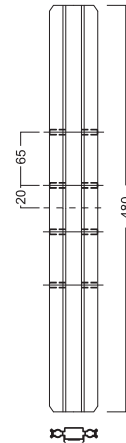
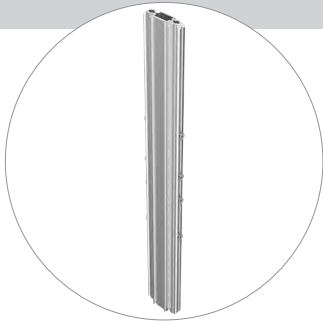

M 1123

M 1123.00

SPIGOT TUBE

aluminium
for extension of upright extrusions
for square extrusions M 1020, M 1021,
M 1012, M 1017
0.891 kg

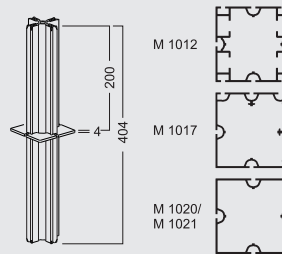
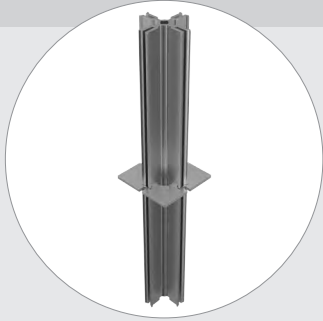

M 1424

M 1424.00

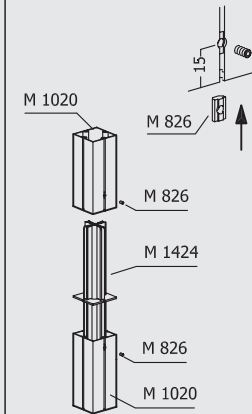

SPIGOT TUBE

aluminium
for extension of upright extrusions
for round extrusions **80 mm dia.**
0.876 kg

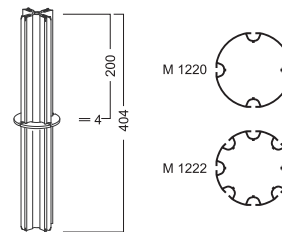
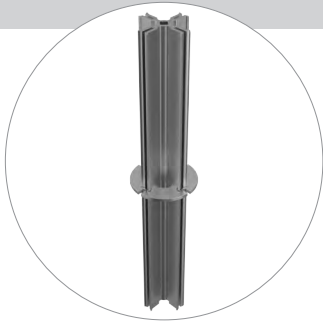

M 1414

M 1414.00

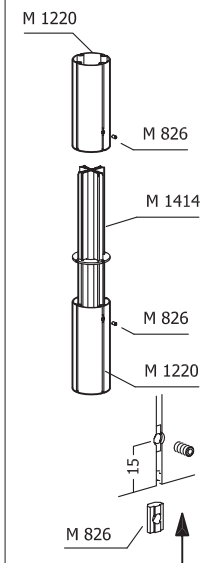

ACCESSORIES

CONNECTORS

SPIGOT TUBE

aluminium
for extension of upright extrusions
for all round extrusions **120 mm dia.**
1.812 kg

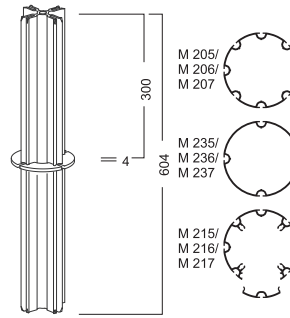
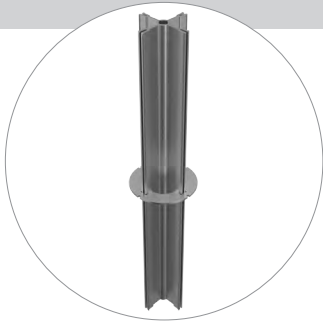

M 1409

M 1409.00

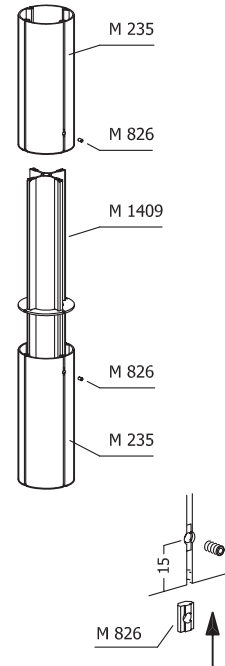

EXTRUSION CONNECTOR

aluminium
usable as extrusion connector
for all square and round extrusions
120 mm
5000 mm long
10.37 kg

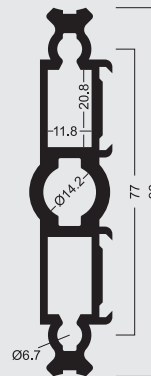

M 1430

M 1430.00

INTERNAL CONNECTOR STRAIGHT

aluminium
incl. 8 countersunk screws M 1102/20 (M5)
for all square and round extrusions
120 mm
with a length up to 999 mm
for vertical or horizontal use
480 mm long
1.077 kg

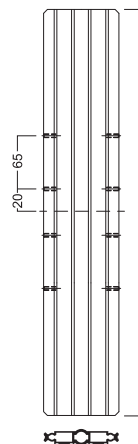
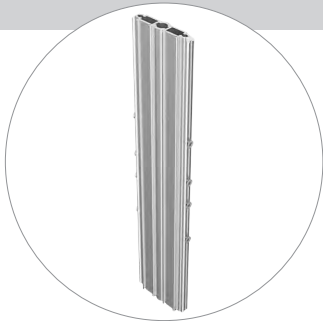

M 1131

M 1131.00

ACCESSORIES

CONNECTORS

INTERNAL CONNECTOR STRAIGHT

aluminium
incl. 8 countersunk screws M 1102/20 (M5)
for all square and round extrusions
120 mm
with a length from 1000 - 3000 mm
720 mm long
1.76 kg

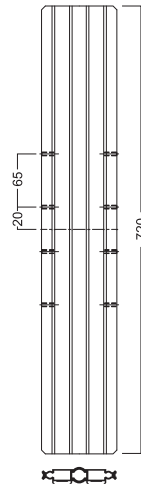
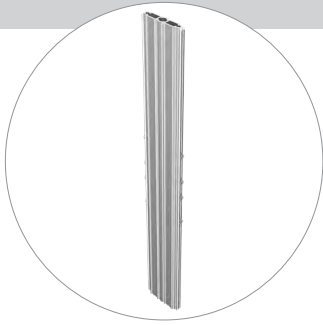

M 1133

M 1133.00

SPIGOT TUBE

aluminium
for extension of upright extrusions
for all square extrusions **120 mm**
1.842 kg

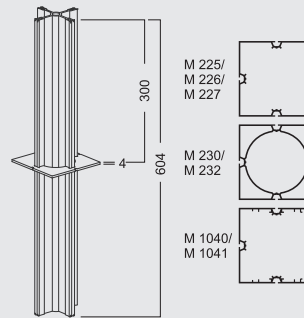
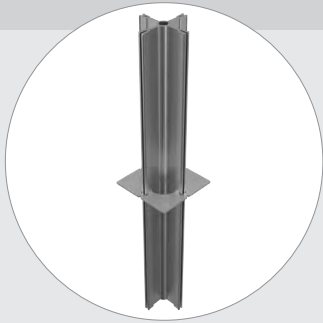

M 1419

M 1419.00

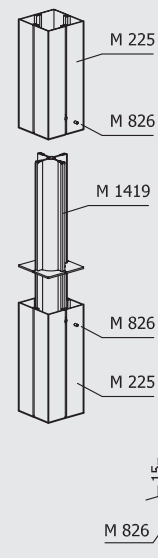

INTERNAL CORNER CONNECTOR

aluminium
incl. 2 countersunk screws E111/m (M6)
suitable for internal and external miters
for quarter-round, square and triangular
extrusions 32 mm
0.031 kg

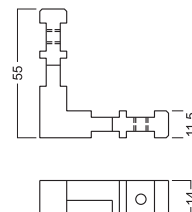
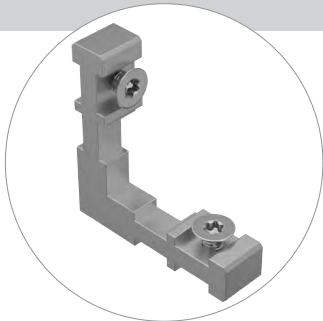

S 1150

S 1150.00

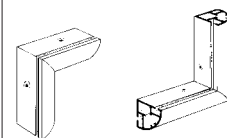

ACCESSORIES

CONNECTORS

INTERNAL CORNER CONNECTOR

aluminium
incl. 2 screws E111/m (M6)
for quarter-round, square and
triangular extrusions 32 mm
adjustable from 90° to 270°
0.034 kg

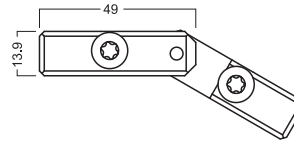

S 1156

S 1156.00

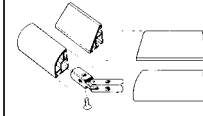

INTERNAL CORNER CONNECTOR

aluminium
incl. 2 countersunk screws M 1611/20 (M5)
for extrusions Z 305, Z 306
0.075 kg

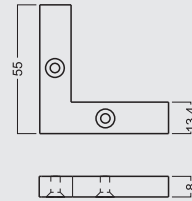

Z 366

Z 366.00

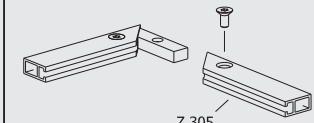

INTERNAL CORNER CONNECTOR

aluminium
incl. 2 hex star screws E 111 and E 111/20
for extrusions with lock chamber
21 x 12 mm
0.082 kg

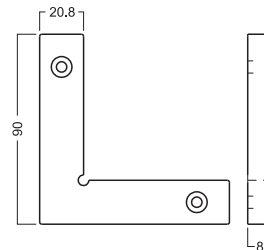

Z 966

Z 966.00

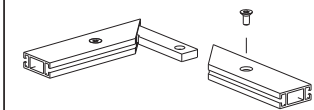

INTERNAL CORNER CONNECTOR

aluminium
incl. 2 countersunk screws E 111 and
washer Z 185
for extrusions with lock chamber
21 x 12 mm
0.076 kg

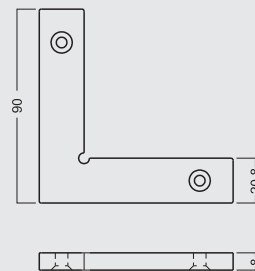

Z 966/S

Z 966/S.00

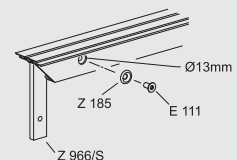

INTERNAL CORNER CONNECTOR

zinc die cast
incl. 2 countersunk screws E 111
and E 111/20
for extrusions with lock chamber
21 x 12 mm
adjustable from 75° to 285°
0.144 kg

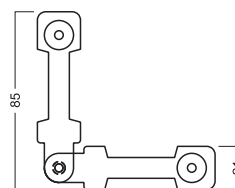

Z 966/V

Z 966/V.00

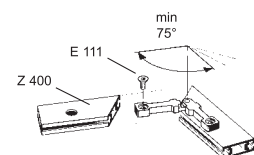

ACCESSORIES

CONNECTORS

INTERNAL CORNER CONNECTOR

aluminium
incl. 2 countersunk screws E 111
and E 111/20
for extrusions with lock chamber
21 x 12 mm
0.061 kg

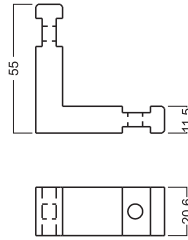

Z 965

Z 965.00

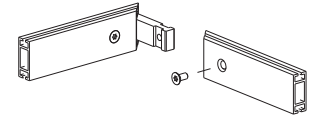

INTERNAL CORNER CONNECTOR

zinc die cast
incl. 2 countersunk screws E 111
and E 111/20
for extrusions with lock chamber
21 x 12 mm
adjustable from 60° to 300°
0.09 kg

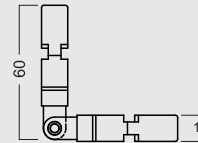

Z 964

Z 964.00

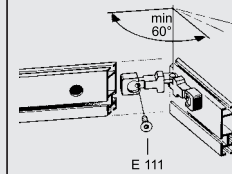

INTERNAL CORNER CONNECTOR

aluminium
incl. 2 countersunk screws E 111
for extrusions with lock chamber
39 x 12 mm
0.109 kg

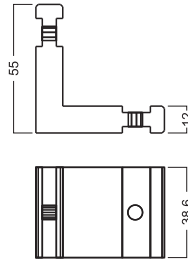

Z 165

Z 165.00

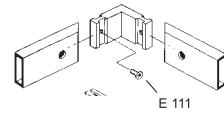

INTERNAL CORNER CONNECTOR

aluminium
incl. 2 countersunk screws E 111
for extrusions with lock chamber
39 x 12 mm
0.15 kg

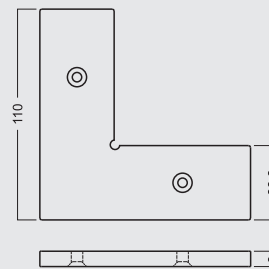

Z 166

Z 166.00

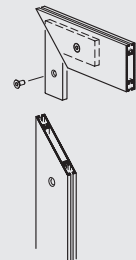

ACCESSORIES

CONNECTORS

INTERNAL CORNER CONNECTOR 135°

steel
incl. 2 set screws M 1075/20 (M4)
for all beam extrusions with
system **groove depth of 10 mm**
0.048 kg

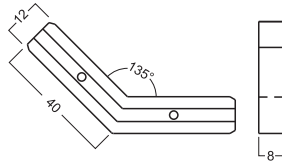
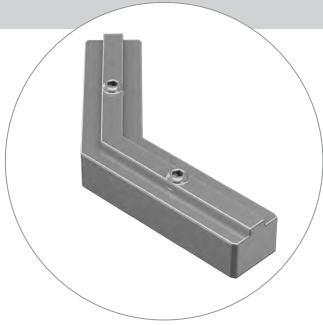

E 282

E 282.37



INTERNAL CORNER CONNECTOR 135°

steel
incl. 2 set screws E 121/Z (M4)
for all beam extrusions with
system **groove depth of 7 mm**
0.032 kg

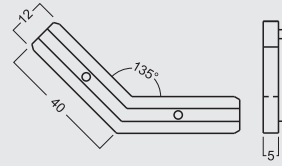
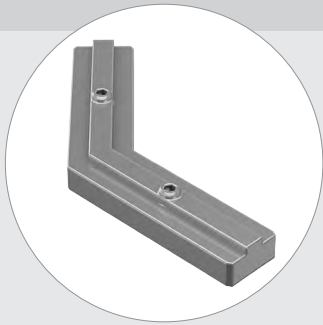

E 283

E 283.37

INTERNAL CORNER CONNECTOR

aluminium
incl. 4 countersunk screws M 1100/20 (M5)
for all square und round extrusions
60 mm
0.124 kg

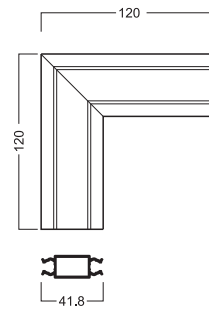
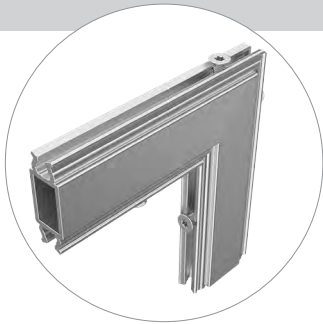

M 1113

M 1113.00

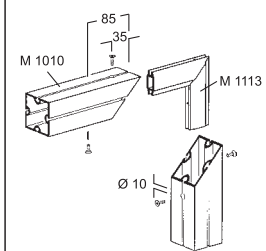

INTERNAL CORNER CONNECTOR

aluminium
incl. 6 countersunk screws M 1611/20 (M5)
for all closed square and round extrusions
80 mm
0.38 kg

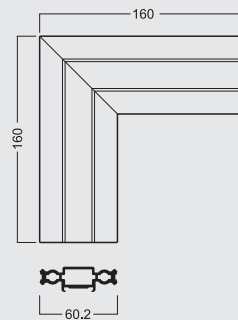
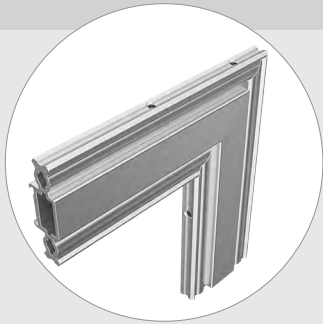

M 1115

M 1115.00

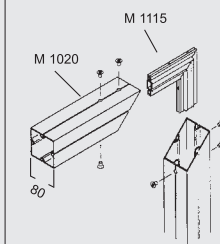

ACCESSORIES

CONNECTORS

INTERNAL CORNER CONNECTOR

aluminium
incl. 8 countersunk screws M 1102/20
for all closed square and round extrusions
120 mm
0.973 kg

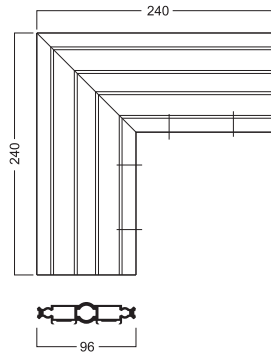
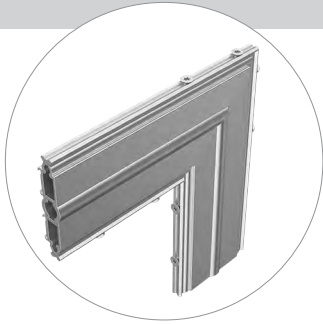

M 1111

M 1111.00

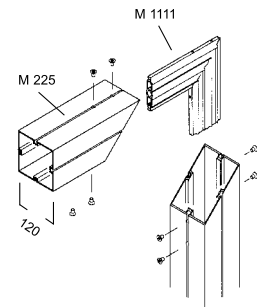

SLIDING PLANE CLAMP

aluminium
for longitudinal connection from system slot
to system slot
at least one **groove must be 10 mm deep**
0.017 kg

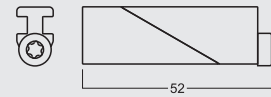
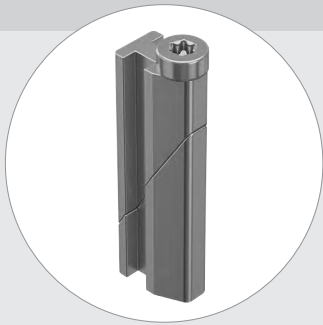

E 261

E 261.00

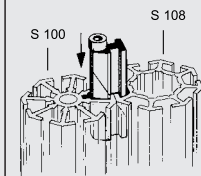

CONNECTING CLAMP

steel
for longitudinal connection from system slot
to system slot
groove depth 7.5 mm
0.024 kg

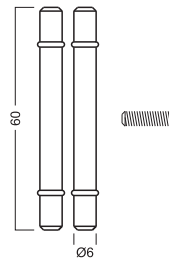

E 262

E 262.37

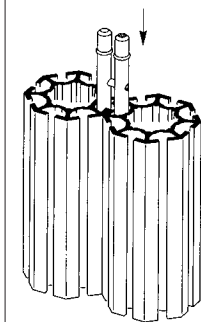

ACCESSORIES

CONNECTORS

CONNECTING CLAMP

steel
for longitudinal connection of 2 system
grooves
groove depth 7.5 mm
0.015 kg



E 263

E 263.00

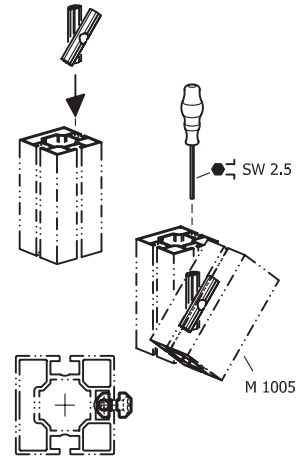

CLIP

stainless steel,
for connection of 2 aluminium extrusions
placed side by side
0.002 kg

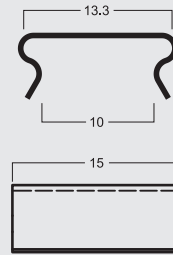
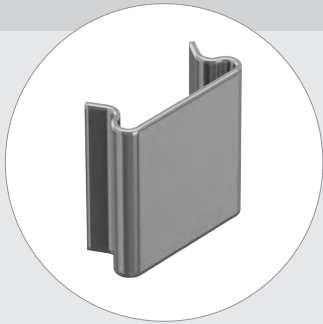

S 1154

S 1154.44

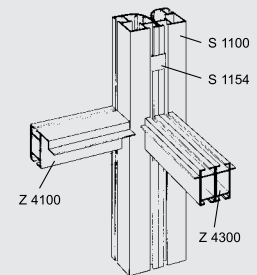

CONNECTOR FOR UPRIGHT EXTRUSION

aluminium
incl. extension spigot S 905
for mounting S 100, S 108
0.051 kg

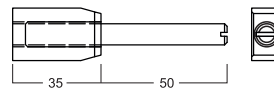
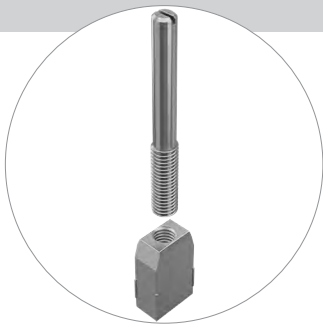

S 137

S 137.37

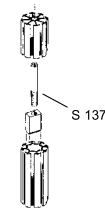

EXTENSION SPIGOT

steel
thread M10
for mounting S 100
0.035 kg

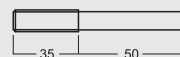

S 905

S 905.37

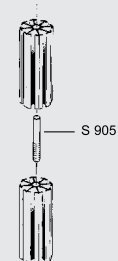

ACCESSORIES

CONNECTORS

CONNECTOR

steel
incl. 1 countersunk screw E111/m (M6)
for quarter-round, square and triangular
extrusions 32 mm
0.048 kg

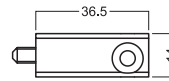

S 1151

S 1151.37

COUPLING PIN

steel
thread M10 on one side
for a loose connection of 2 knuckle joints
with thread M10
0.011 kg

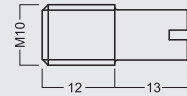

S 1181

S 1181.37

STRAIGHT CONNECTOR

aluminium
incl. 2 set screws S 6035/20 (M6)
0.008 kg

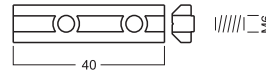

M 1417

M 1417.00

STRAIGHT CONNECTOR

aluminium
incl. 2 set screws S 6035/20 (M6)
0.011 kg



M 1421

M 1421.00

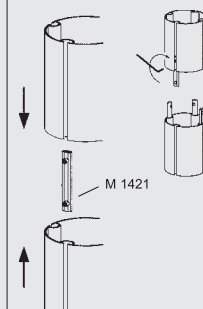

ACCESSORIES

CONNECTORS

STRAIGHT CONNECTOR

aluminium
incl. 2 set screws S 6035/20 (M6)
for extension of 2 extrusions with system
groove 4.3 mm
for long MAXIMA Light 120 mm extrusions
use internal connector M 1131/M 1133
additionally
0.017 kg

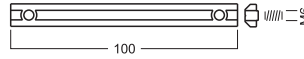

M 1425

M 1425.00

STRAIGHT CONNECTOR

zinc die cast
incl. 2 setscrews M4 and 1 hexagon wrench
1 pair
0.032 kg

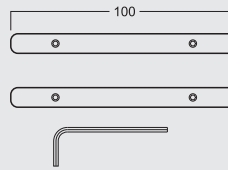

VA 5000

VA 5000.00

ACCESSORIES

HINGE PLATES AND HINGES

HINGE PLATE

aluminium
incl. mounting parts and distance washers
for hinged glass and wooden doors 5, 6, 8, 16, 19 mm
0.08 kg

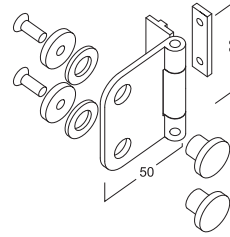
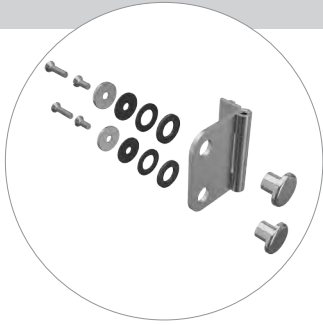

E 290

E 290.01

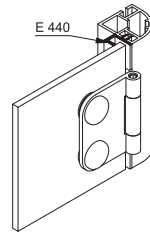

HINGE PLATE

aluminium
incl. mounting parts and distance washers
for hinged glass and wooden doors 5, 6, 8, 16, 19 mm
0.061 kg

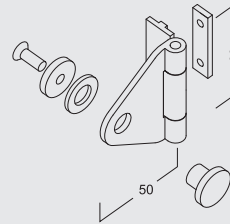

E 290/D

E 290/D.01

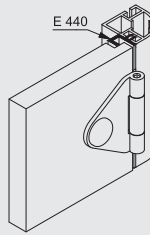

GLASS DOOR HINGE

zinc die cast
incl. mounting parts
no drill hole in glass panel is necessary!
for glass doors 5 - 6 mm
1 pair
0.212 kg

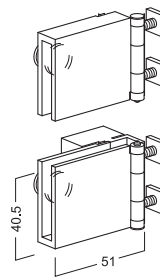

E 297

E 297.39
E 297.41
E 297.42

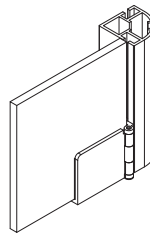

GLASS DOOR HINGE

zinc die cast
incl. mounting parts
can be used on left hand and right hand side, also as middle hinge plate
drill hole 12 mm dia. in glass panel is necessary!
for glass doors 5 - 6 mm
0.106 kg

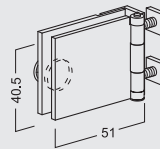

E 297/M

E 297/M.39
E 297/M.41

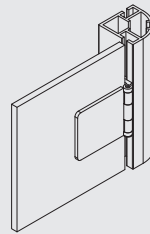

ACCESSORIES

HINGE PLATES AND HINGES

GLASS DOOR HINGE

steel/plastic
incl. mounting parts
no drill hole in glass panel is necessary!
for hinged glass doors 4 - 5.5 mm
1 pair
0.056 kg

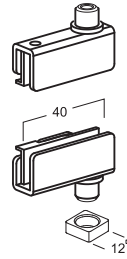

V 2225

V 2225.41

GLASS DOOR HINGE

zinc die cast
with door stop and clamping screw
no drill hole in glass panel is necessary!
for hinged glass doors 4 - 6 mm
1 pair
0.053 kg

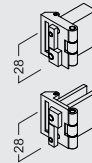
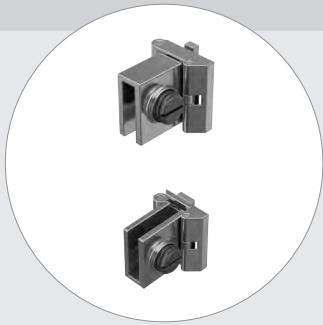

M 1637

M 1637.38

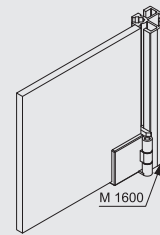

HINGE PLATE

brass
left hand version
incl. 2 threaded plates E 470/E and
2 countersunk screws E 297/Z (M4)
for hinged wooden doors 16 mm
0.047 kg

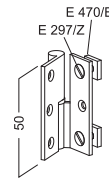

E 296/L

E 296/L.38

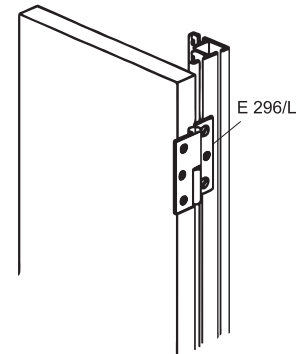

HINGE PLATE

brass
right hand version
incl. 2 threaded plates E 470/E and
2 countersunk screws E 297/Z (M4)
for hinged wooden doors 16 mm
0.047 kg

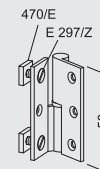

E 296/R

E 296/R.38

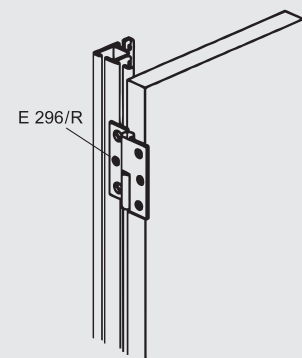

ACCESSORIES

HINGE PLATES AND HINGES

HINGE PLATE

aluminium
 hinge plate can only be mounted on the right side of the door leaf
 incl. 2 threaded plates E 212/P and 4 countersunk screws E 297/Z (M4)
 for mounting to system groove 4.3 mm
for doors DIN left
 0.15 kg

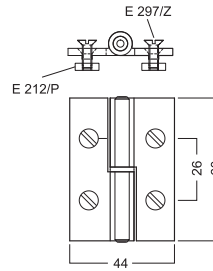

E 300

E 300.01

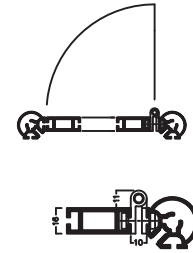
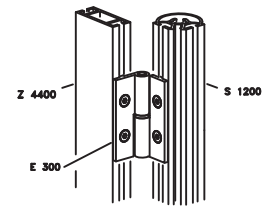

HINGE PLATE

aluminium
 incl. 4 countersunk screws E 2720/20 (M4)
 for mounting to system groove 4.3 mm
 0.115 kg

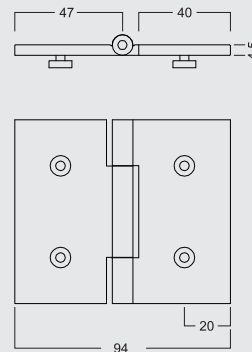

E 306

E 306.01

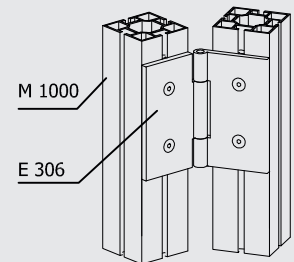
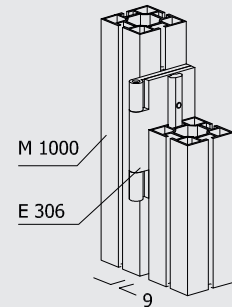

HINGE PLATE LEFT

aluminium
left hand version
can be unhinged
 incl. 4 countersunk screws E 2720/20 (M4)
 for mounting to system groove 4.3 mm
 0.115 kg

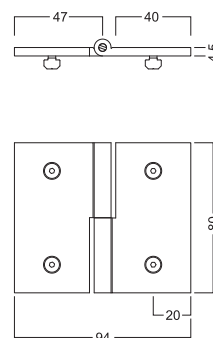

E 307/L

E 307/L.01

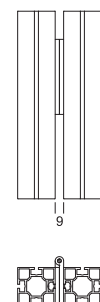

ACCESSORIES

HINGE PLATES AND HINGES

HINGE PLATE RIGHT

aluminium
right hand version
can be unhinged
 incl. 4 countersunk screws E 2720/20 (M4)
 for mounting to system groove 4.3 mm
 0.115 kg

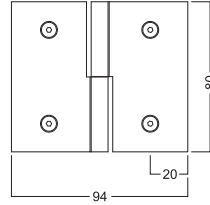
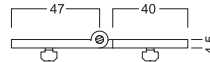

E 307/R

E 307/R.01

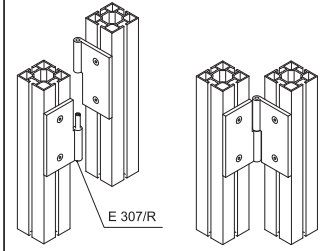

HINGE

aluminium
 incl. 4 threaded plates E 470/E
 and 4 countersunk screws E 297/Z (M4)
 for mounting to system groove 4.3 mm
 0.13 kg

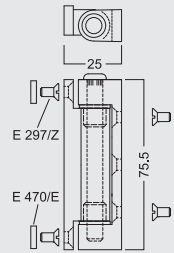
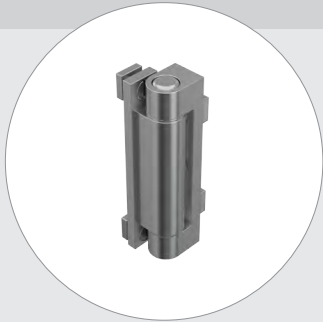

E 305

E 305.21

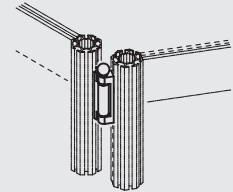

HINGE PIN

steel
 to connect and disconnect quickly E 305
 0.043 kg

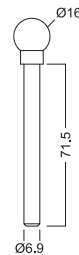

E 310

E 310.37

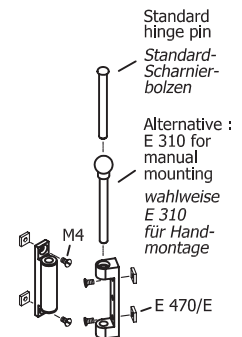

ACCESSORIES

SHOWCASE AND FURNITURE ACCESSORIES

HINGED BOLT LOCK

metal
incl. 2 keys E 292/Sch
key can only be removed when locked
for hinged wooden doors 16 and 19 mm
0.062 kg

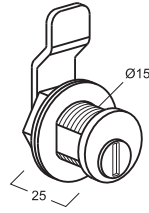

E 291

E 291.38

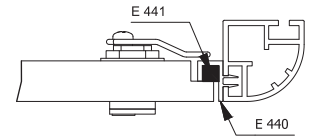

HINGED BOLT LOCK

metal
incl. 2 keys E 292/Sch
key can only be removed when locked
for hinged glass doors 5 - 8 mm
0.066 kg

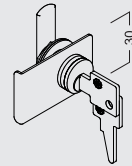

E 292

E 292.38

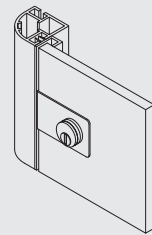

SUSPENSION PLATE

metal
with dummy cylinder
for two hinged glass doors 5 - 6 mm
in conjunction with E 292
0.046 kg

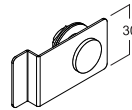

E 292/A

E 292/A.38

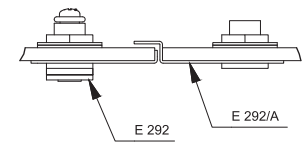

GLASS DOOR LOCK

zinc die cast/steel
requires drilling, incl. 2 keys
for hinged glass doors 4 - 6 mm
0.105 kg

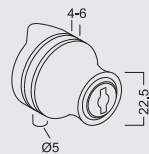

V 2226

V 2226.38

HANDLE

zinc die cast
with clamping screw E 297/K
for hinged glass doors 4 - 6 mm
for use in conjunction with M 1637
0.018 kg



M 1638

M 1638.39

ACCESSORIES

SHOWCASE AND FURNITURE ACCESSORIES

UPPER TRACK FOR SLIDING DOORS

plastic, hard
for 4 mm panels
5000 mm long
0.6 kg

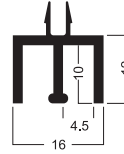

E 400

E 400.30
E 400.33
E 400.35

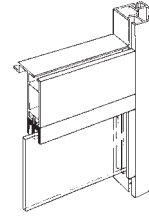

LOWER TRACK FOR SLIDING DOORS

plastic, hard
for 4 mm panels
5000 mm long
0.45 kg

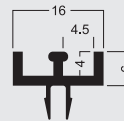

E 401

E 401.30
E 401.33
E 401.35

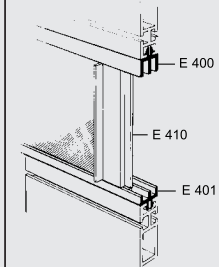

DOOR HANDLE EXTRUSION

plastic, hard
for 4 mm panels
5000 mm long
0.5 kg

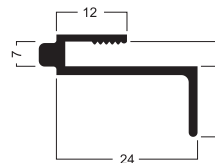

E 410

E 410.30
E 410.35

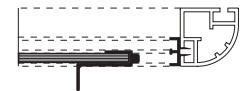

DOOR HANDLE EXTRUSION

aluminium
for 4 mm panels
5000 mm long
1.2 kg

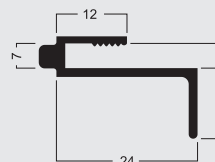

E 410/AL

E 410/Al.01

7

ACCESSORIES

SHOWCASE AND FURNITURE ACCESSORIES

SLIDING DOOR LOCK

metal/plastic
incl. 2 keys E 292/Sch
key can be removed when locked or unlocked
for 4 - 6 mm panels
0.084 kg



E 295/N

E 295/N.33

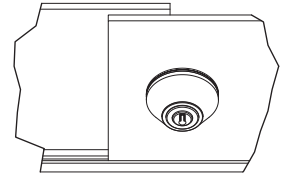

SLIDING DOOR EXTRUSION

aluminium
for 5 and 6 mm glass sliding doors
(plastic clip E 470/C to be ordered separately)
5000 mm long
1.74 kg

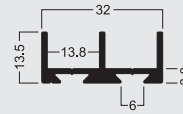

E 470/N

E 470/N.01

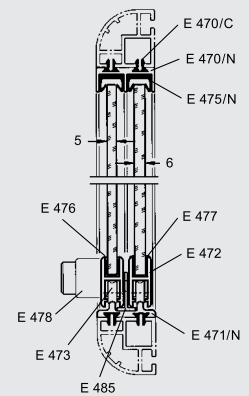

RUNNER

aluminium
for runner frame extrusion E 472
(plastic clip E 470/C to be ordered separately)
5000 mm long
1.61 kg

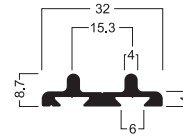

E 471/N

E 471/N.01

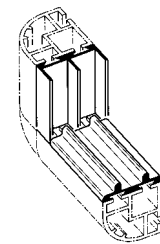

CLIP

plastic
to put into extrusion E 470/N, E 471/N
recommendation: 4 pieces / running meter

for extrusion C 722
recommendation: 2 pieces / running meter
0.002 kg

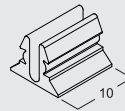
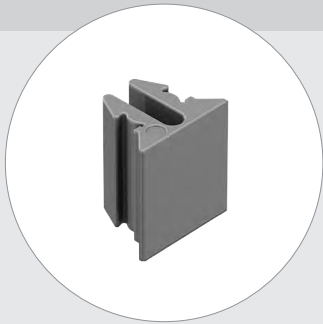

E 470/C

E 470/C.30

ACCESSORIES

SHOWCASE AND FURNITURE ACCESSORIES

RUNNER FRAME EXTRUSION

aluminium
for glass thickness 5 and 6 mm
5000 mm long
1.74 kg



E 472

E 472.01

ROLLER

steel
to screw in extrusion E 472
0.014 kg

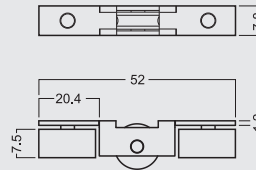

E 473

E 473.37

ROLLER

steel
with 2 fixing holes 2.8 mm dia. for wood screws
for wooden sliding doors (max. 13 mm)
0.008 kg

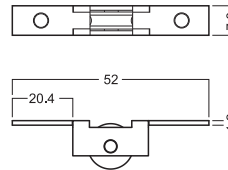

E 473/H

E 473/H.37

END PIECE

zinc die cast
for lateral connection to extrusion E 472
0.011 kg

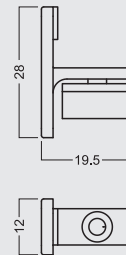

E 474

E 474.39

ANTI-RATTLE EXTRUSION

rubber
with flocking, hard - soft, self-adhesive
to be glued on top/at the side of
extrusion E 470/N
5000 mm long
0.33 kg

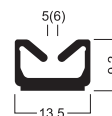

E 475/N

E 475/N.33

ACCESSORIES

SHOWCASE AND FURNITURE ACCESSORIES

FLAT RUBBER

rubber
self-adhesive
to be glued into the vertical built-in
extrusion E 470/N
10000 mm long
0.558 kg



E 480

E 480.33

CLAMPING EXTRUSION

plastic, soft
to insert 5 mm glass in extrusion E 472
5000 mm long
0.157 kg



E 476

E 476.51

CLAMPING EXTRUSION

plastic, soft
to insert 6 mm glass in extrusion E 472
5000 mm long
0.167 kg



E 477

E 477.51

SLIDING DOOR LOCK

zinc die cast
incl. 2 keys E 479
universal, for use on left and right hand
side
to be mounted in extrusion E 472
0.097 kg

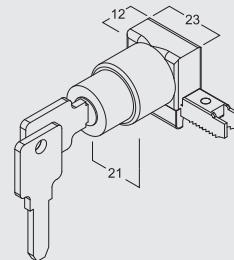

E 478

E 478.39

REPLACEMENT KEY

metal
for sliding door lock E 478
0.009 kg



E 479

E 479.38

ACCESSORIES

SHOWCASE AND FURNITURE ACCESSORIES

LOCKING PLATE

zinc die cast
incl. 2 fixing screws M3
to be used in conjunction with E 478
0.007 kg

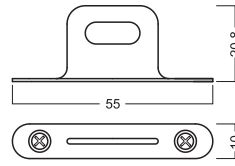

E 485

E 485.39

LOCKING END PIECE

zinc die cast/steel
with locking facility
for mounting in extrusion E 472,
alternative to E 478
0.023 kg

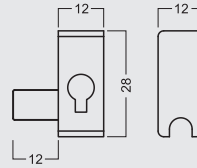
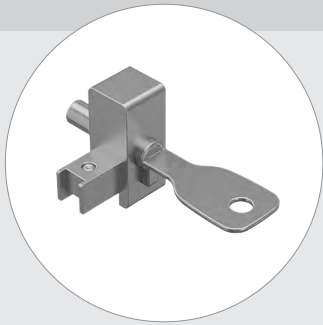

E 484

E 484.39

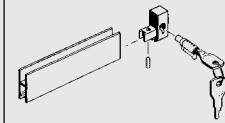

GLIDE HANDLE

zinc die cast
to be mounted in extrusion E 472
for glass thickness 5 and 6 mm
0.055 kg

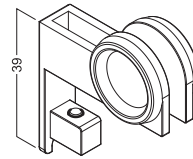

E 481

E 481.39

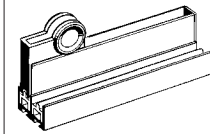

ACCESSORIES

HAMMERHEAD SCREWS AND SHELF SUPPORTS

HAMMERHEAD SCREW

steel
for system groove 4.3 mm
0.024 kg

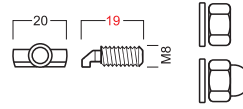

M 1472

HAMMERHEAD SCREWS

M 1472.37

HAMMERHEAD SCREW

steel
for system groove 4.3 mm
0.025 kg

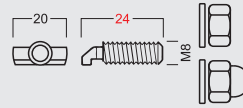

M 1473

M 1473.37

HAMMERHEAD SCREW

steel
for system groove 4.3 mm
0.041 kg

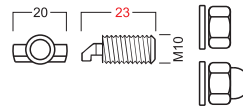

M 812

M 812.37

HAMMERHEAD SCREW

steel
for system groove 4.3 mm
0.012 kg

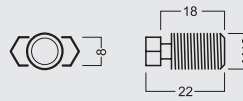

E 265

E 265.37

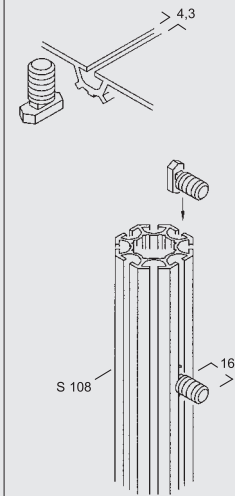

ACCESSORIES

HAMMERHEAD SCREWS AND SHELF SUPPORTS

HAMMERHEAD SCREW

steel
sleeve E 209/Hü with combination cross
recess
for system groove 4.3 mm
maximum load capacity 35 kg
0.009 kg



E 203

SHELF SUPPORT

E 203.38

HAMMERHEAD SCREW

steel
incl. plastic ring E 201
sleeve E 204, 10 mm dia., elongated slot
and allen screw 4 mm
for system groove 4.3 mm
maximum load capacity 35 kg
0.012 kg



E 205

E 205.38

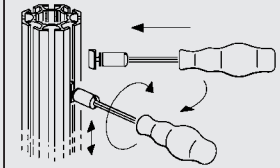

HAMMERHEAD SCREW

steel
with large hammerhead E 207/Ha (18 mm)
sleeve E 210/Hü with combination
cross-slot
for system groove 4.3 mm
maximum load capacity 35 kg
0.009 kg

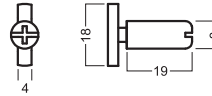

E 207

E 207.38

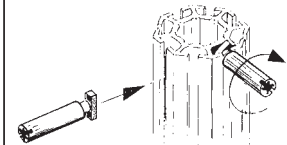

HAMMERHEAD SCREW

steel
sleeve E 209/Hü with combination
cross-slot
for system groove 4.3 mm
maximum load capacity 35 kg
0.009 kg

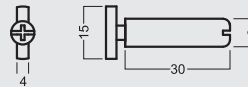

E 209

E 209.38

HAMMERHEAD SCREW

steel
sleeve E 210/Hü with combination
cross-slot
for system groove 4.3 mm
maximum load capacity 35 kg
0.007 kg

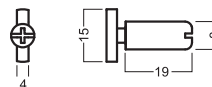

E 210

E 210.38

ACCESSORIES

HAMMERHEAD SCREWS AND SHELF SUPPORTS

SUPPORTING ANGLE

aluminium
incl. hammerhead screw E 210
maximum load capacity 35 kg
0.009 kg

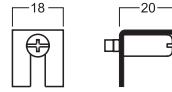

E 211

SHELF SUPPORT

E 211.37

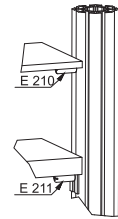

HAMMERHEAD SCREW

steel/plastic
with threaded sleeve M8, hexagon socket
4 mm and plastic sleeve for glass shelf
for system groove 4.3 mm
maximum load capacity 35 kg
0.006 kg

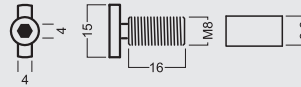

E 210/M8

E 210/M8.30
E 210/M8.35

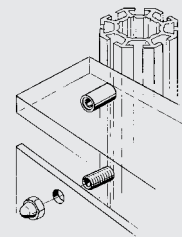

SLEEVE

plastic
with knock-on shelf retainer to hold glass
shelf
in conjunction with E 210/M8
0.003 kg

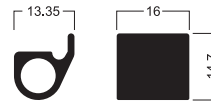

E 217

E 217.35

SHELF SUPPORT 10 MM DIA.

steel
10 mm dia.
for extrusion S 1200
0.01 kg



S 1225

S 1225.38

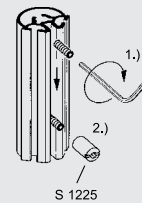

ACCESSORIES

HAMMERHEAD SCREWS AND SHELF SUPPORTS

SHELF SUPPORT 8 MM DIA.

steel
8 mm dia.
for extrusion S 1200
0.007 kg



S 1226

S 1226.38

SHELF SUPPORT

aluminium
incl. plastic bumper for glass shelves
and set screw E 213/Z (M4)
for extrusions S 1224, M 1618
0.01 kg

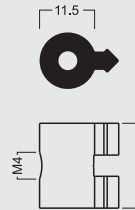

S 1240

S 1240.00

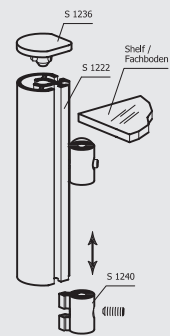

SHELF SUPPORT

zinc die cast
incl. plastic bumper M 1670/K for glass
shelves and set screw M 1431/20 (M4)
maximum load 25 kg per supporting beam
for extrusion M 1600
0.004 kg

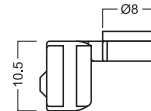

M 1670

M 1670.37

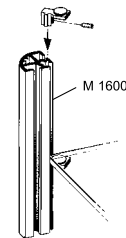

SHELF SUPPORT

aluminium/steel
incl. set screw M 1671/G (M5)
for extrusions M 1620, M 1622,
M 1625, M 1629
0.007 kg



M 1671

M 1671.37

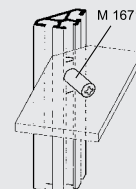

ACCESSORIES

HAMMERHEAD SCREWS AND SHELF SUPPORTS

SHELF SUPPORT

plastic
incl. set screw V 2220/G (M4)
for extrusions V 2000, V 2020,
M 1620, M 1622, M 1625, M 1629
0.006 kg

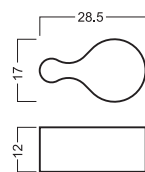

V 2220

SHELF SUPPORT

V 2220.35
V 2220.36



SHELF SUPPORT

plastic/steel
incl. clamping screw M4
only for extrusion V 2000
0.008 kg

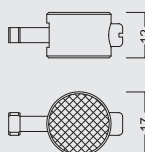

V 2222

V 2222.35

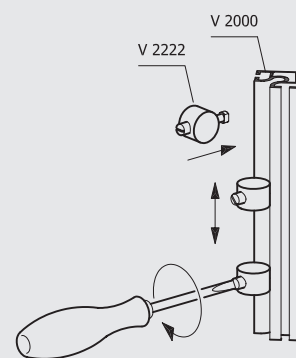

BRACKET FOR GLASS SHELF

steel
incl. hammerhead bolt M 1142,
set screw M 615 (M6)
and 2 plastic screws M 1586/2 (M10)
for mounting to system groove 4.3 mm
**for glass thickness 8 mm, maximum
load 10 kg**
**for glass thickness 10 mm, maximum
load 15 kg**
0.361 kg

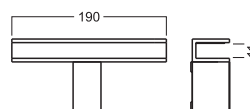

M 1586

M 1586.21

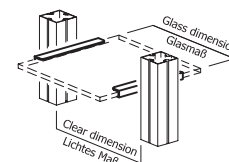

Clear dimension - 10 mm = Glass dimension
Lichtes Maß - 10 mm = Glasmaß

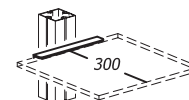

BRACKET FOR GLASS SHELF

aluminium
incl. 2 set screws M 262/G (M4) and shelf
support E 718
for 8 mm glass shelves
299 mm long
0.183 kg

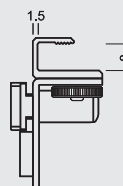

E 719

E 719.01

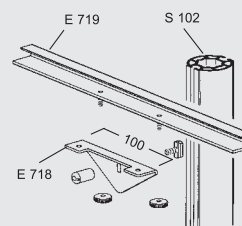

ACCESSORIES

HAMMERHEAD SCREWS AND SHELF SUPPORTS

BRACKET FOR WOODEN SHELVES

steel
incl. hammerhead screw E 204 for mounting to system groove 4.3 mm
for wooden shelves, maximum depth 350 mm
100 mm long
0.051 kg

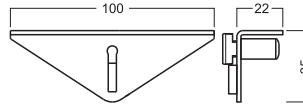

E 718

E 718.21

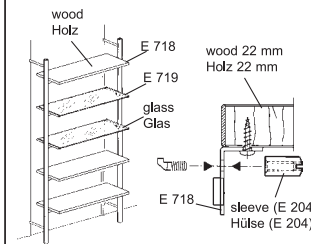

BRACKET FOR WOODEN SHELVES

steel, powder-coated
100 mm long
incl. 2 hammerhead screws E 205 for mounting to system groove 4.3 mm
for up to 30° sloping
for wooden shelves, maximum depth 350 mm
0.053 kg

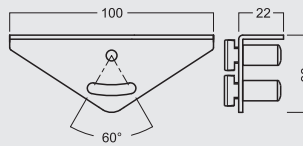

E 728

E 728.21

INTERIOR CORNER CONNECTOR

aluminium
incl. 2 hammerhead screws E 202 with sleeve E 210/Hü
for all shelf brackets with tension lock Z 961/13
70 mm long
0.042 kg

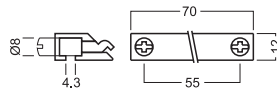

E 702

E 702.01

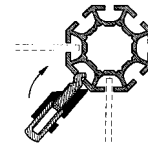

ACCESSORIES

SHELF BRACKETS

SHELF BRACKET

aluminium
incl. tension lock Z 961/13 and
end cap E 708/K
for mounting to system groove 4.3 mm
maximum distributed dead load 35 kg
100 mm long
0.106 kg

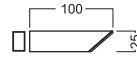

E 708

E 708.01
E 708.11

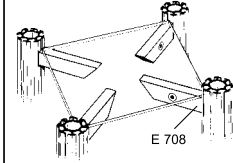

END CAP

plastic
for E 708
0.002 kg

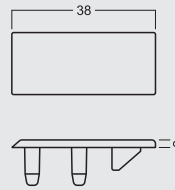

E 708/K

E 708/K.30
E 708/K.35

SHELF BRACKET 150 MM

aluminium
incl. tension lock Z 961/13 and
adaptor Z 161/A
for mounting to system groove 4.3 mm
maximum distributed dead load 35 kg
150 mm long
0.143 kg

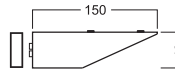

E 710

E 710.01
E 710.11

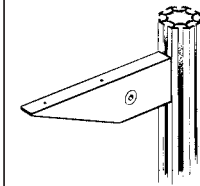

END CAP

plastic
for E 710
0.005 kg

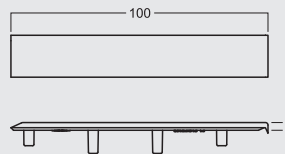

E 710/K

E 710/K.30
E 710/K.35

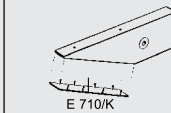

SHELF BRACKET 200 MM

aluminium
incl. tension lock Z 961/13 and
adaptor Z 161/A
for mounting to system groove 4.3 mm
maximum distributed dead load 35 kg
200 mm long
0.142 kg

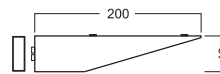

E 711

E 711.01
E 711.11

ACCESSORIES

SHELF BRACKETS

SHELF BRACKET 250 MM

aluminium
incl. tension lock Z 961/13 and
adaptor Z 161/A
for mounting to system groove 4.3 mm
maximum distributed dead load 30 kg
250 mm long
0.155 kg

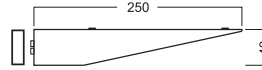

E 712

E 712.01
E 712.11

SHELF BRACKET 300 MM

aluminium
incl. tension lock Z 961/13
and adaptor Z 161/A
for mounting to system groove 4.3 mm
maximum distributed dead load 25 kg
300 mm long
0.175 kg

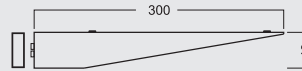

E 713

E 713.01
E 713.11

SHELF BRACKET CONNECTOR

aluminium
incl. plastic set screw E 720/M8
for mounting a row of shelves on brackets
E 708 - E 713
23 mm long
0.017 kg

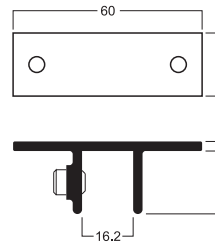

E 720/G

E 720/G.01

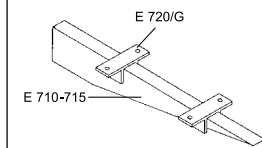

SHELF BRACKET

aluminium
incl. tension lock Z 961/13 and
adaptor Z 161/A
for mounting to system groove 4.3 mm
adjustable end piece left hand
for horizontal and 20° inclined shelves,
maximum distributed dead load 25 kg
300 mm long
0.213 kg

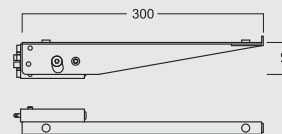

E 723

E 723.11

E 723 E 733 E 743

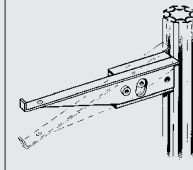
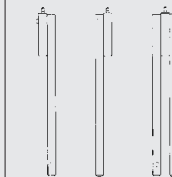

ACCESSORIES

SHELF BRACKETS

SHELF BRACKET

aluminium
incl. tension lock Z 961/13 and
adaptor Z 161/A
for mounting to system groove 4.3 mm
adjustable end piece right hand
for horizontal and 20° inclined shelves,
maximum distributed dead load 25 kg
300 mm long
0.212 kg

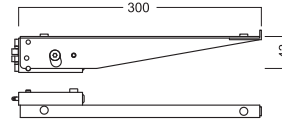

E 733

E 733.11

SHELF BRACKET

aluminium
incl. tension lock Z 961/13 and
adaptor Z 961/A
for mounting to system groove 4.3 mm
both end pieces adjustable
for horizontal and 20° inclined shelves,
maximum distributed dead load 25 kg
300 mm long
0.284 kg

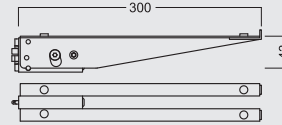

E 743

E 743.11

SLIDE-IN SHELF BRACKET

aluminium
incl. 2 set screws E 111/4*14
to be used in conjunction with graphic
panel retainer E 271
maximum distributed dead load 20 kg
0.12 kg

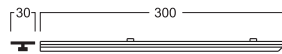

E 725

E 725.01

SLIDE-IN SHELF BRACKET 20°

aluminium
incl. 2 set screws E 111/4*14
to be used in conjunction with graphic
panel retainer E 271
maximum distributed dead load 20 kg
0.111 kg

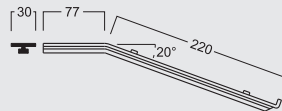

E 726

E 726.01

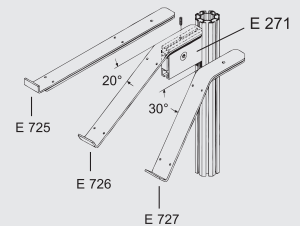

ACCESSORIES

SHELF BRACKETS

SLIDE-IN SHELF BRACKET 30°

aluminium
incl. 2 set screws E 111/4*14
and anti-slipping device M 1670/K
to be used in conjunction with graphic
panel retainer E 271
maximum distributed dead load 20 kg
0.109 kg

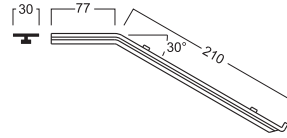

E 727

E 727.01

BRACKETS / STRAIGHT 300 MM

steel
pair / left and right
for wooden shelf 16 mm, glass shelf 8 mm
or aluminium shelf E 739
for mounting to system groove 4.3 mm
(S 100, S 108)
maximum distributed dead load 35 kg
Attention: for wooden or glass shelves
boreholes 6.4 mm dia. necessary!
0.488 kg

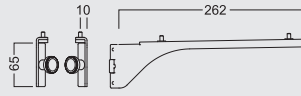

E 735

E 735.90

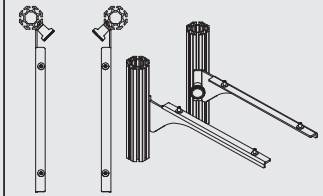

SHELF BRACKET 30°

steel
pair / left and right
for wooden shelf 16 mm and up, glass shelf
8 mm
or aluminium shelf E 739,
for mounting to system groove 4.3 mm
(S 100, S 108)
maximum distributed dead load 35 kg
Attention: for wooden or glass shelves
borehole 6.4 mm dia. are necessary!
0.476 kg

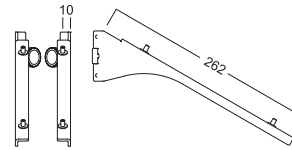

E 737

E 737.90

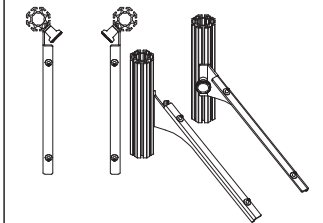

SHELF BOARD

aluminium, powder coated
for variable use, for brackets E 735 and
E 737
Attention: only for axis measurement
990 mm
5.878 kg

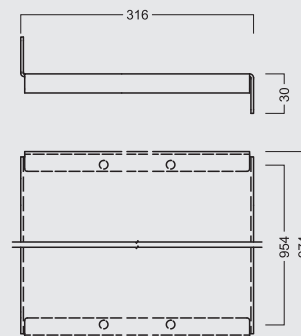

E 739

E 739.21

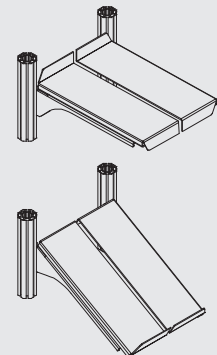

ACCESSORIES

SHELF BRACKETS

PANEL RETAINER

steel
with drill hole 4.5 mm dia.
0.013 kg

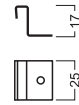
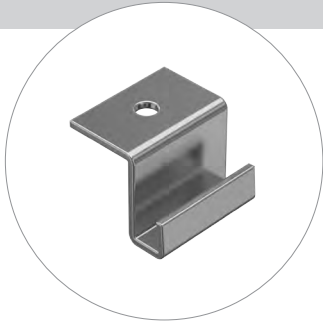

E 221

E 221.38

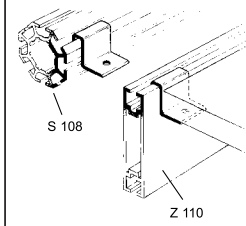

SHELF EXTRUSION

aluminium
for hooking into beams with system groove
4.3 mm
5000 mm long
9 kg

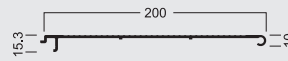
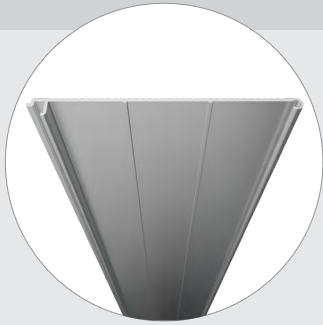

E 315

E 315.01

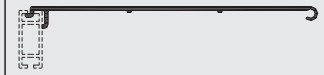

END CAP

plastic
for shelf extrusion E 315

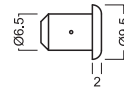

E 318

E 318.35

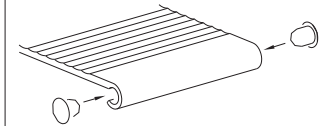

ACCESSORIES

BRACING PARTS

ANGLE REINFORCEMENT

steel
incl. hammerhead fixing set M 1142 on
both ends
for system groove 4.3 mm
0.37 kg

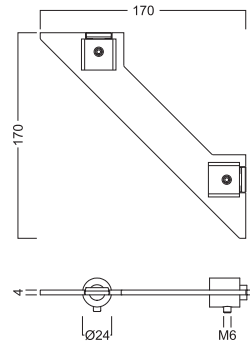

M 1112

M 1112.21

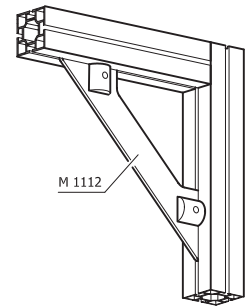

ANGLE REINFORCEMENT

steel
incl. 2 set screws M 1435/70 (M8) and
2 round head screws with flange
M 1557/20 (M6)
for system groove 4.3 mm
0.205 kg

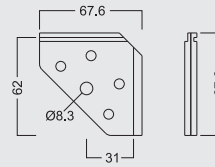

M 1150

M 1150.37

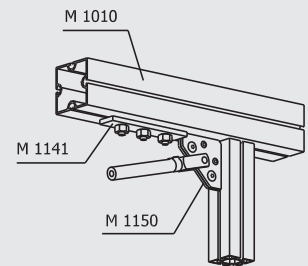

ANGLE REINFORCEMENT

steel
incl. 3 set screws M 1435/70 (M8) and
2 round head screws with flange
M 1557/20 (M6)
for system groove 4.3 mm
0.376 kg

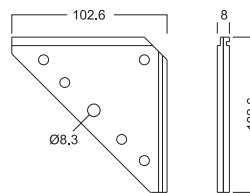

M 1129

M 1129.37

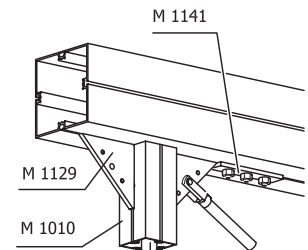

ACCESSORIES

BRACING PARTS

ANGLE REINFORCEMENT

steel
incl. 4 set screws M 1435/70 (M8) and
4 round head screws with flange
M 1557/20 (M6)
for system groove 4.3 mm
1.981 kg

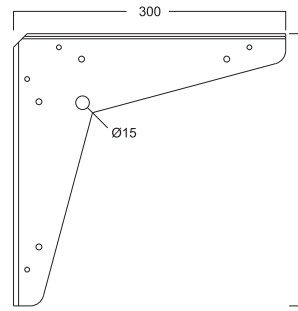

M 1139

M 1139.37

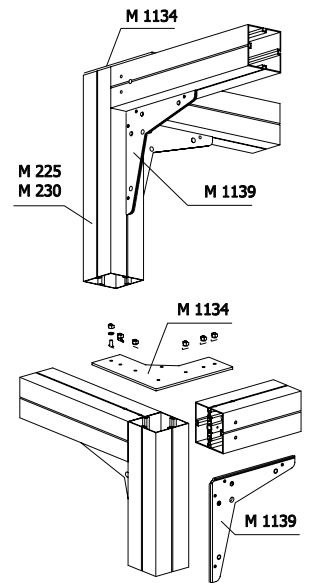

CONNECTOR PART

steel, zinc plated
incl. 2 set screws M 1435/70 (M8) and
1 round head screw with flange
M 1557/20 (M6)
for system groove 4.3 mm
0.411 kg

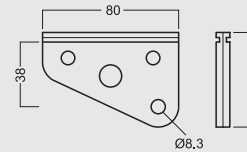

M 1292

M 1292.37

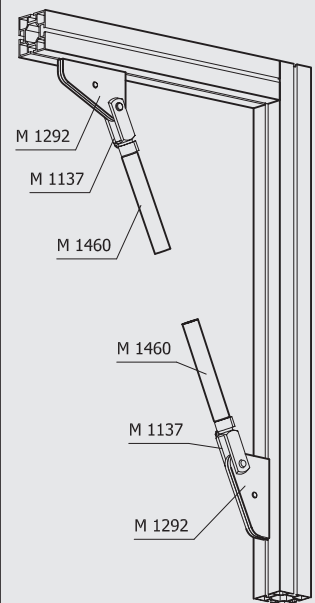

CONNECTOR PART

steel
incl. 3 set screws M 1435/70 (M8) and
2 round head screws with flange
M 1557/20 (M6)
for system groove 4.3 mm
0.338 kg

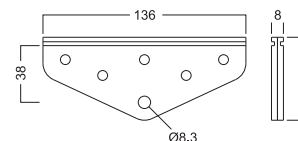

M 1132

M 1132.37

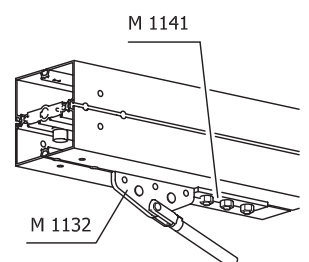

ACCESSORIES

FIXING AND SECURITY PARTS

THREADED PLUG

aluminium
with thread M10
for extrusions with lock chamber
21 x 12 mm
0.016 kg

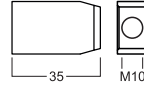

S 137/K

S 137/K.00

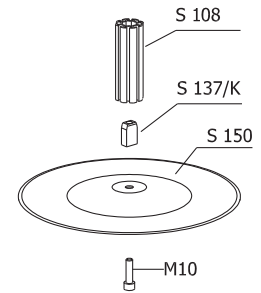

THREADED PLUG

aluminium
with thread M10
for extrusions with lock chamber
21 x 12 mm
0.049 kg

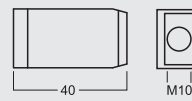

Z 980/G

Z 980/G.00

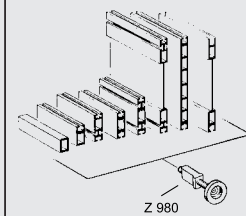

THREADED INSERT

steel
thread M10 (20 mm deep)
incl. 1 countersunk screw E111/m (M6)
for extrusion chambers 14 x 14 mm
0.035 kg

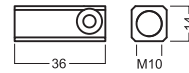

S 1133

S 1133.37

THREADED PLATE M8/M6

aluminium
incl. mounting parts
for extrusions with lock chamber
21 x 12 mm
55 mm long
0.073 kg

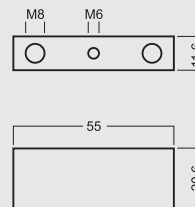

M 1327

M 1327.00

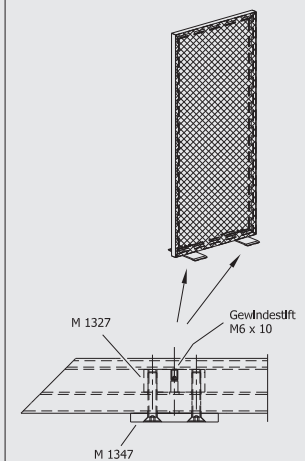

ACCESSORIES

FIXING AND SECURITY PARTS

THREADED PLATE M8

aluminum
for extrusions with lock chamber
21 x 12 mm
70 mm long
0.065 kg

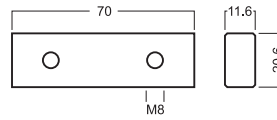

M 1349

M 1349.00

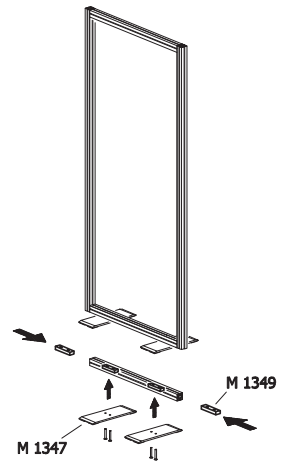

THREADED PLATE

steel
with antislipping device
female thread M4
for system groove 4.3 mm
0.004 kg



M 1078

M 1078.37

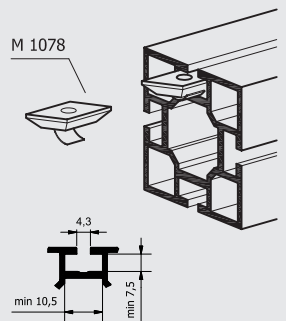

THREADED PLATE

steel
female thread M4
for system groove 4.3 mm
0.002 kg

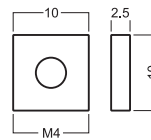

E 470/E

E 470/E.37

THREADED PLATE

steel
female thread M4
for 20 mm and 22 mm extrusions

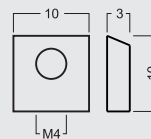

M 1636

M 1636.37

ACCESSORIES

FIXING AND SECURITY PARTS

REINFORCING PLATE

steel
incl. 2 set screws E 212/Z (M4)
to support the tension lock Z 961/13
for groove depth 7.5 mm
0.01 kg

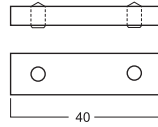

E 212

E 212.37

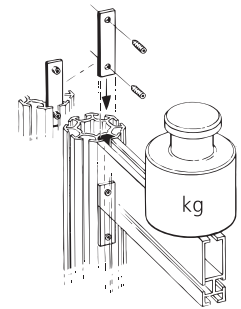

REINFORCING PLATE

steel
incl. 2 set screws E 213/Z (M4)
to support the tension lock Z 961/13
for groove depth 10 mm
0.01 kg

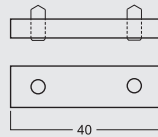

E 213

E 213.37

ANGLE

steel
incl. 1 set screw S 6025/20 (M6)
0.015 kg

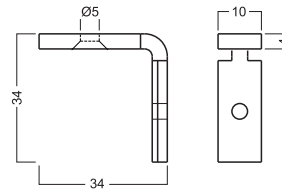

S 6035

S 6035.37

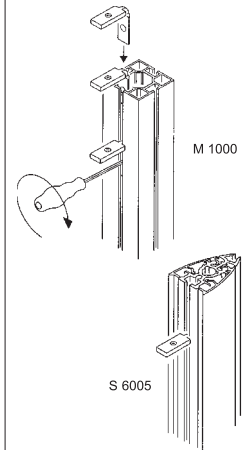

ACCESSORIES

FIXING AND SECURITY PARTS

FIXING ANGLE

steel
for 80 mm and 120 mm square extrusions
without mounting parts
0.207 kg

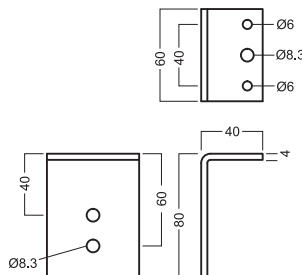
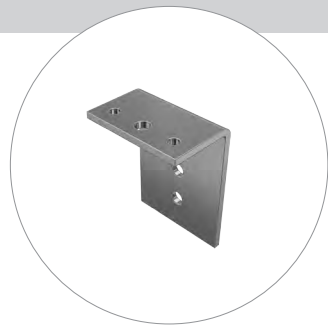

M 1117

M 1117.37

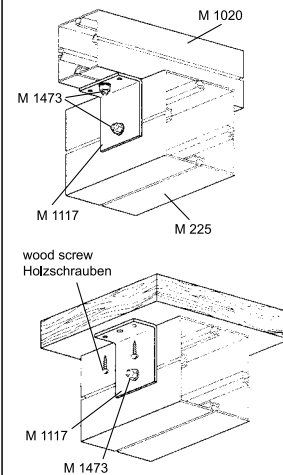

FIXING ANGLE

steel
for 40 mm and 80 mm square extrusions
without mounting parts
0.05 kg

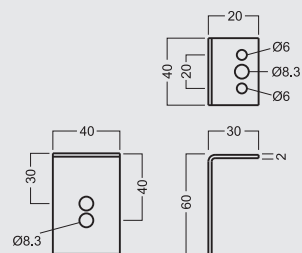

M 1160

M 1160.37

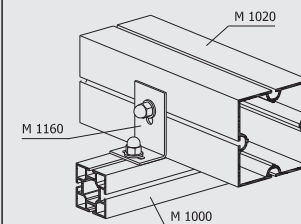

BRACKET FOR WIRE ROPE

steel
incl. 1 dome nut M 1471/30 (M8),
1 washer M 1471/40 and
2 hammerhead screws M 1472
0.164 kg

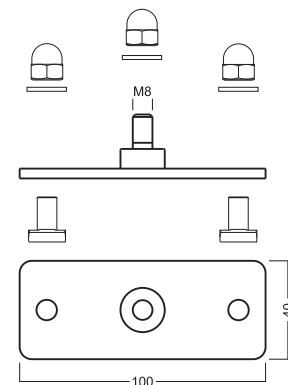
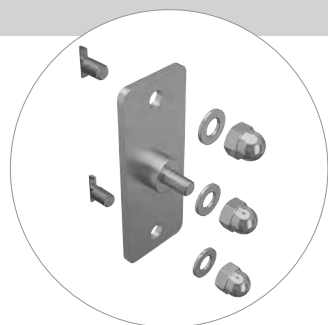

M 1118

M 1118.21

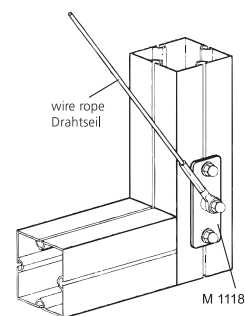

ACCESSORIES

FIXING AND SECURITY PARTS

ANGLE FOR FIXING OF WIRE ROPE

steel
incl. 4 hammerhead screws M 815
for cable fixing
60 mm wide
0.634 kg

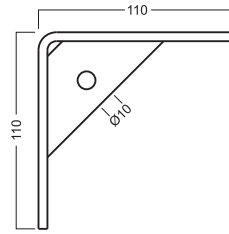

M 1107

M 1107.21

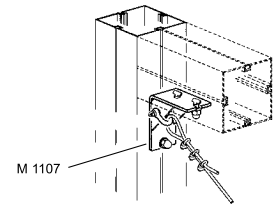

CONNECTOR PART

aluminium
incl. 2 set screws M 1435/70 (M8)
for system groove 4.3 mm
0.065 kg

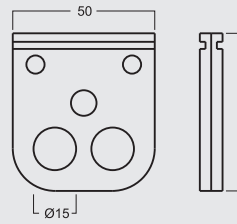

M 1435

M 1435.00

CONNECTOR PART

steel
for system groove 4.3 mm
0.061 kg

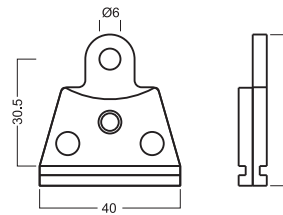

M 1290

M 1290.37

ROUND TUBE

aluminium
6000 mm long
2.567 kg



M 1460

M 1460.01

ACCESSORIES

FIXING AND SECURITY PARTS

BANNER ATTACHMENT SET

steel
for mounting to system groove 4.3 mm
0.039 kg

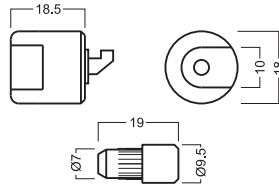
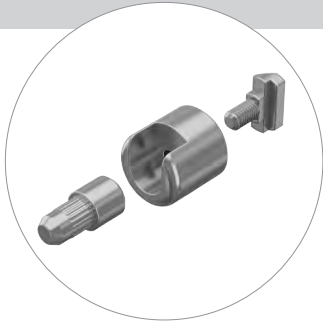

M 1369

M 1369.37

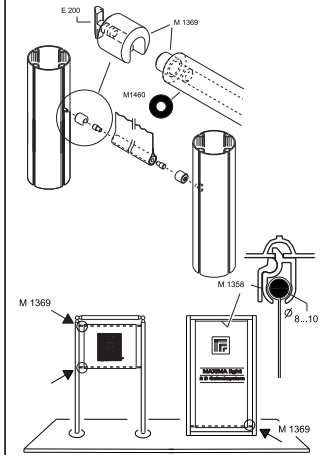

QUICKLINK

steel
incl. 1 set screw M 1137/20 /M8
1 hexagon nut M 1137/30 (M8)
and spring hinged bolt
for mounting to round tube M 1460
0.102 kg

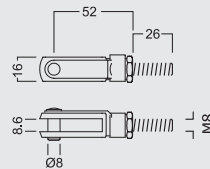

M 1137

M 1137.37

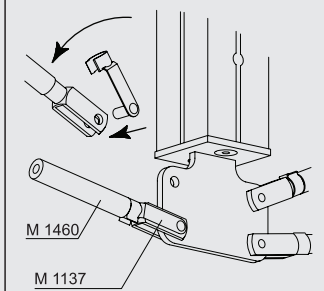

ROUND TUBE

aluminium
5000 mm long
4.756 kg

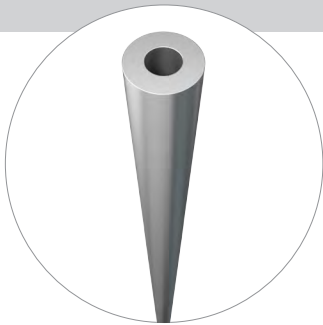

M 1140

M 1140.01

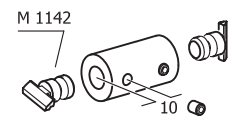

ACCESSORIES

FIXING AND SECURITY PARTS

THREADED INSERT M6

steel
female thread M6
for round tube M 1140
0.01 kg

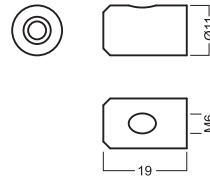

M 1138

M 1138.37

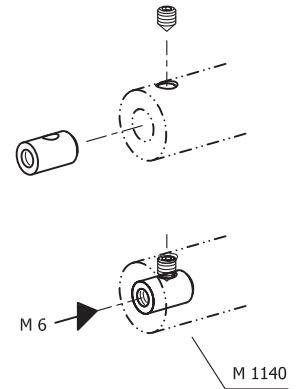

HAMMERHEAD BOLT

steel
for round tube M 1140
incl. set screw M 1104/21 (M6)
for system groove 4.3 mm
0.014 kg

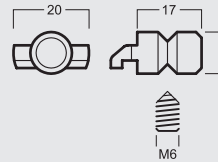
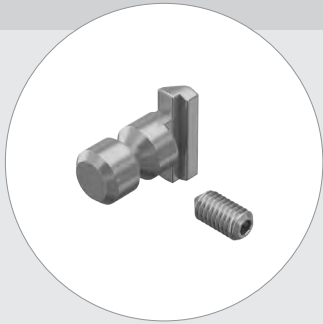

M 1142

M 1142.37

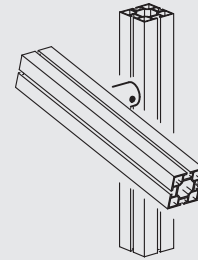

HAMMERHEAD BOLT

steel
for round tube M 1140
incl. set screw M 1104/21 (M6)
for system groove 4.3 mm
0.022 kg

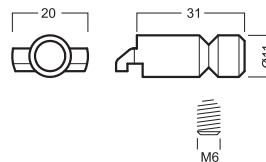
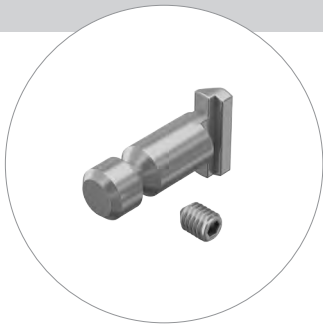

M 1145

M 1145.37

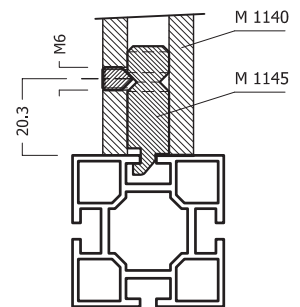

ACCESSORIES

FIXING AND SECURITY PARTS

FIXING-SET

steel
for M 1140
incl. washer 10 mm
for system groove 4.3 mm
0.039 kg

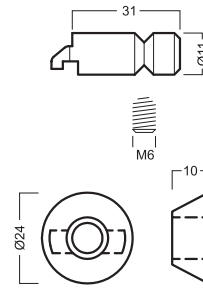
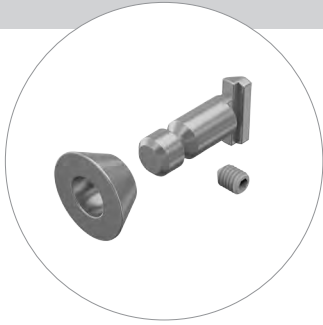

M 1147

M 1147.37

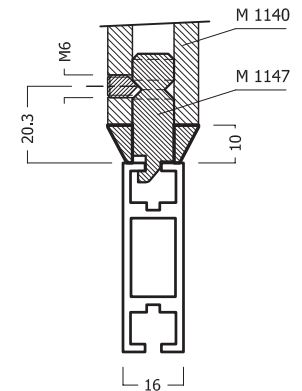

END CAP

steel
for round tube M 1140
0.029 kg

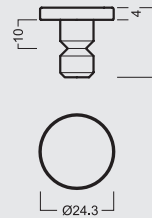
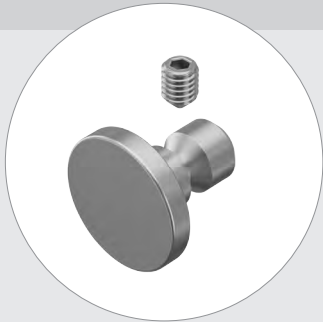

M 1149

M 1149.39

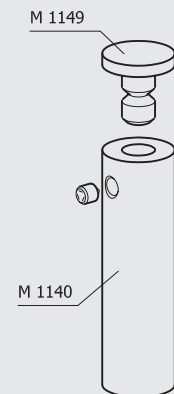

COUPLING PIN

steel
for connection of round tube M 1140
with hinged set M 1457
0.041 kg

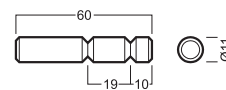

M 1144

M 1144.37

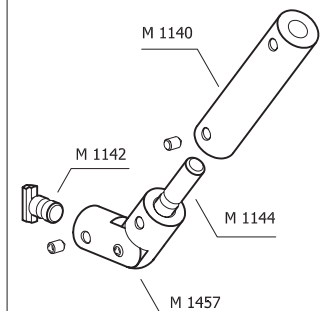

ACCESSORIES

FIXING AND SECURITY PARTS

WALL MOUNTING PLATE

steel
for wall fixing of round tube M 1140
0.08 kg

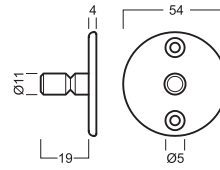

M 1148

M 1148.37

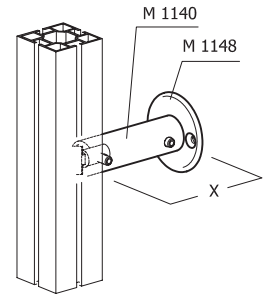

DISTANCE PIECE

aluminium/steel
incl. 1 set screw S 4330/20 (M5) and
1 hammerhead screw S 4330/2 (M10)
adjustable
0.154 kg

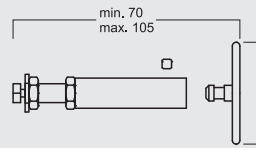
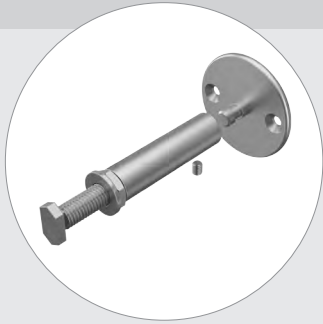

S 4330

S 4330.01

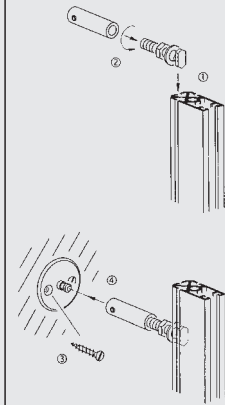

DISTANCE PIECE

aluminium/steel
incl. 1 set screw S 4330/20 (M5) and
1 hammerhead screw S 4330/2 (M10)
adjustable
0.168 kg

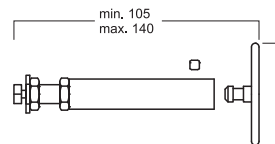

S 4331

S 4331.01

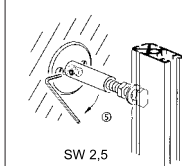

ACCESSORIES

MISCELLANEOUS

DRAPERY GLIDER

plastic
for system groove 4.3 mm

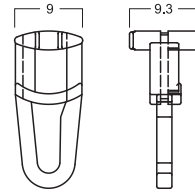

E 240

E 240.30

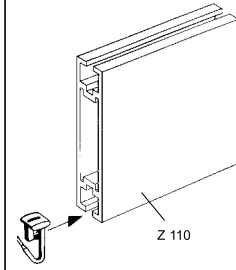

SCREW EYE

steel
with 1 hammerhead screw E 218/1 (M5)
for system groove 4.3 mm
maximum load 45 kg
0.013 kg

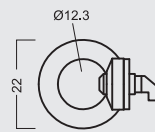

E 218

E 218.41

SCREW HOOK

steel
with plastic washer
for system groove 4.3 mm
maximum load 8 kg
0.006 kg

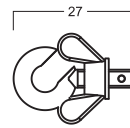

E 219

E 219.37

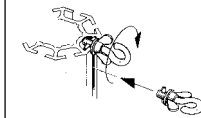

BAG HOLDER

steel
with black plastic ball head
for system groove 4.3 mm
maximum load 15 kg
0.055 kg

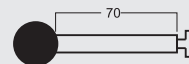

E 275

E 275.38

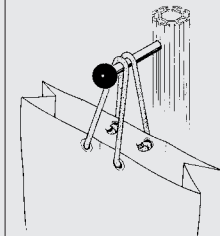

ACCESSORIES

ADJUSTABLE FEET AND CASTORS

ADJUSTABLE FOOT

aluminium/steel
with thread M10
for extrusions with lock chamber
21 x 12 mm
0.102 kg

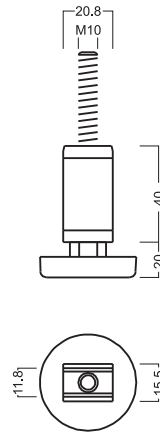

Z 980

Z 980.37

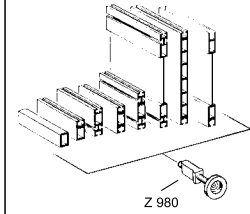

ADJUSTABLE BEAM FOOT

aluminium/steel
thread M10
for extrusions Z 100 and Z 110
0.125 kg

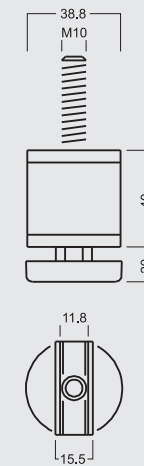
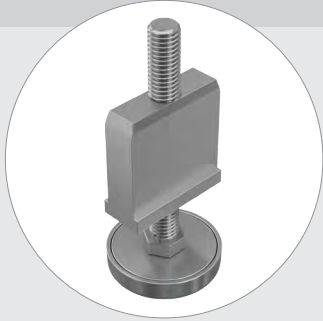

Z 180

Z 180.37

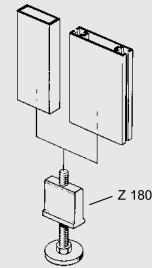

ADJUSTABLE FOOT

cast aluminium/steel, zinc-plated
to support curved beams
0.116 kg

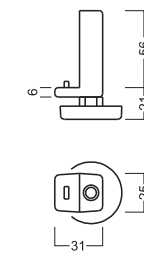

E 250

E 250.90

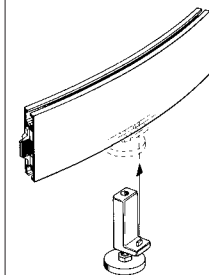

ACCESSORIES

ADJUSTABLE FEET AND CASTORS

ADJUSTABLE FOOT

steel
height adjustable from **31 - 49 mm**
for square extrusion V 2000
0.073 kg

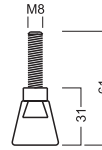

V 2214

V 2214.37

THREADED PLATE M10

zinc die cast
female thread M10
for use with extrusions M1600, M1620 and M1625
0.115 kg

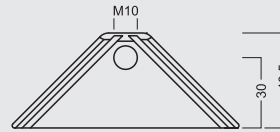
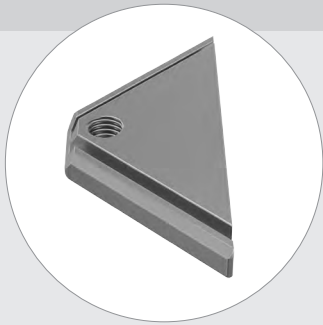

M 1635

M 1635.00

THREADED PLATE M10

zinc die cast
female thread M10
to be used with quarter-round, square and triangular extrusions 32 mm
0.115 kg

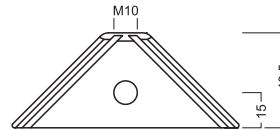
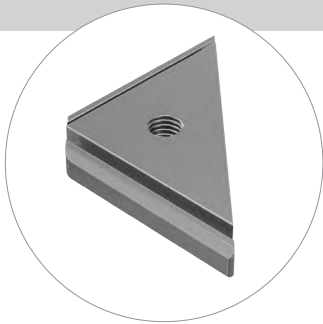

S 1335

S 1335.00

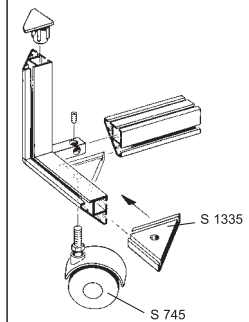

THREADED PLATE 135°

zinc die cast
female thread M10
to be used for extrusion S 1129 in conjunction with knuckle joints S 1179 and S 1339
0.101 kg

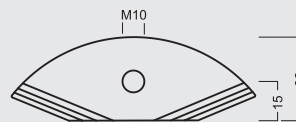

S 1345

S 1345.00

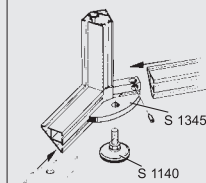

ACCESSORIES

ADJUSTABLE FEET AND CASTORS

ADJUSTABLE FOOT

steel/plastic, chrome-plated cover
height adjustable from **20 - 28 mm**
0.037 kg

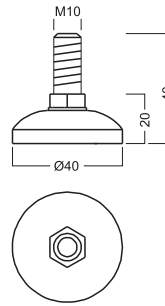

S 1140

S 1140.41

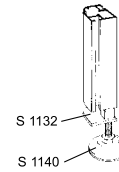

ADJUSTABLE FOOT

steel/plastic, chrome-plated cover
height adjustable from **20 - 45 mm**
0.053 kg

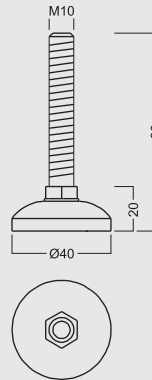

S 1141

S 1141.41

CASTOR

plastic
mounting height 63 mm
maximum dead load 55 kg
0.039 kg

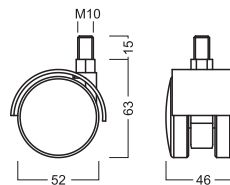

S 745

S 745.33

CASTOR

plastic
same as S 745, but **with brake**
mounting height 63 mm
maximum dead load 55 kg
0.038 kg

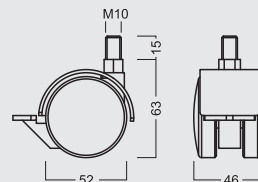

S 746

S 746.33

ACCESSORIES

ADJUSTABLE FEET AND CASTORS

CLAMPING PIN

steel
for mounting of castors S 745, S 746
to system groove 4.3 mm
0.036 kg

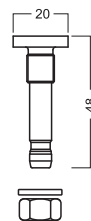

S 748

S 748.37

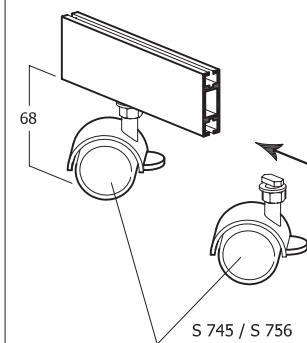

ACCESSORIES

BASE PLATES

BASE PLATE 320 X 120 MM

steel
incl. supporting peg M 1408/2,
1 countersunk screw eZ5030/20 (M10) and
1 countersunk screw E 111/m (M6)
for upright extrusions M 1000, S 108...
3.487 kg

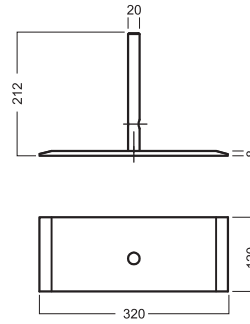

M 1408

M 1408.21

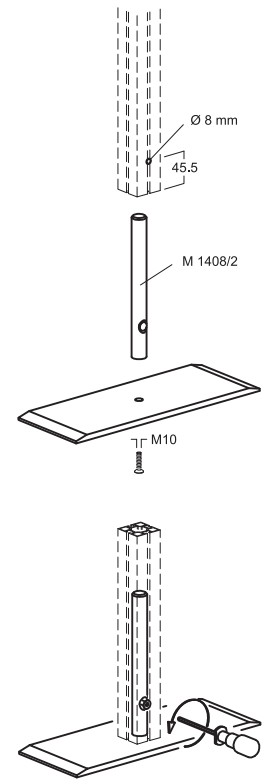

BASE PLATE 300 X 300 MM

steel
incl. adaptor M 1407/2,
2 countersunk screws M 1406/20 (M8) and
4 countersunk screws M 1611/20 (M5)
for all square and round extrusions 60 mm
4.939 kg

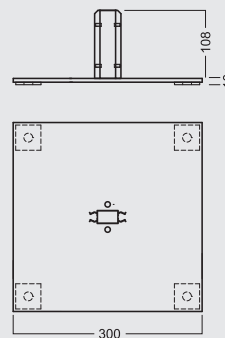

M 1407

M 1407.21

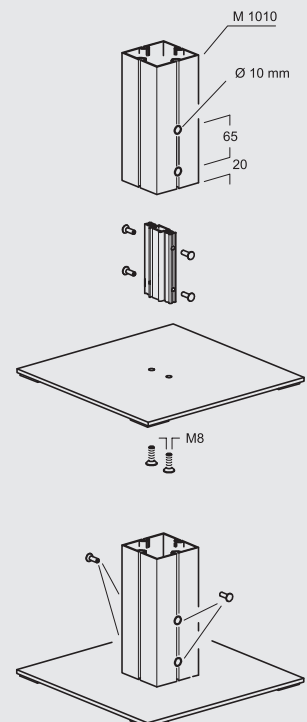

ACCESSORIES

BASE PLATES

BASE PLATE 300 X 300 MM

steel
incl. adaptor M 1406/2,
2 countersunk screws M 1406/20 (M8)
and 4 countersunk screws M 1611/20 (M5)
for all square and round extrusions **80 mm**
4.915 kg

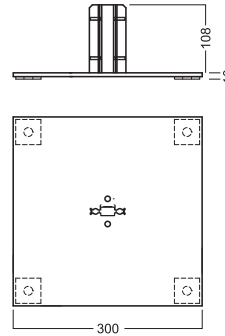

M 1406

M 1406.21

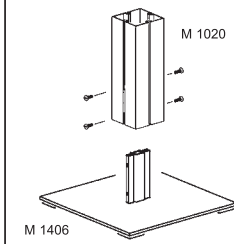

BASE PLATE, ADJUSTABLE 300 X 300 MM

steel
adjustable from 0°-14° in 2° steps
for all square extrusions **80 and 120 mm**
6.584 kg

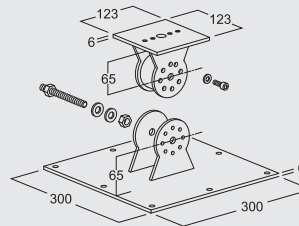
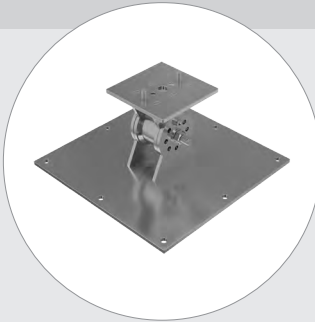

M 1416

M 1416.21

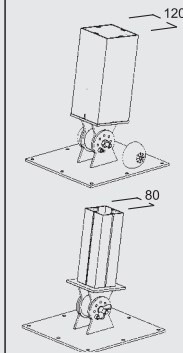

BASE PLATE 450 X 450 MM

steel
incl. adaptor M 825/A
and 4 countersunk screws eZ5030/20 (M10)
for all square extrusions 120 mm and all
closed round extrusions **120 mm dia.**
11.444 kg

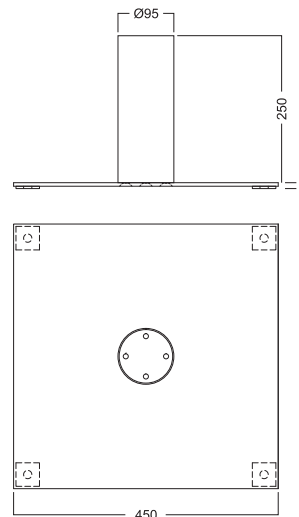
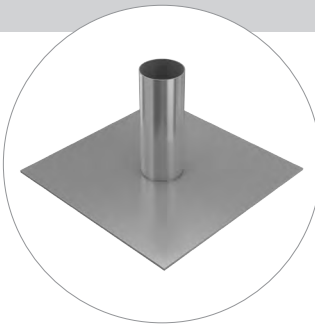

M 1426

M 1426.21

ACCESSORIES

BASE PLATES

TRUMPET BASE

cast aluminium
incl. 1 cylinder screw VA 7500/21 (M10) for
extrusion S 100
in conjunction with threaded plug S 137/K
for extrusions S 108, M 1202, M 1204, Q 43
and S 201
5.4 kg

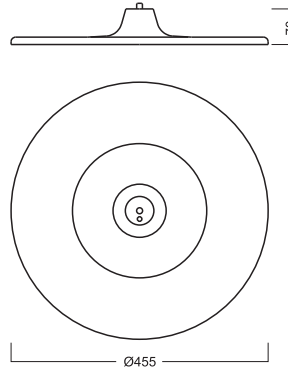

S 141

S 141.21

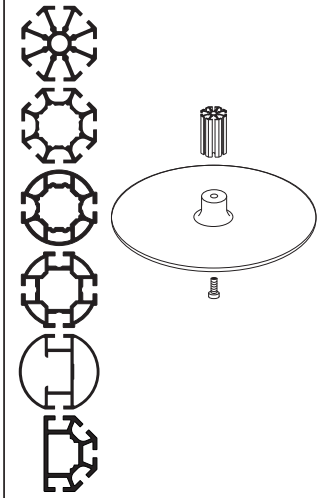

BASE PLATE

steel
incl. 1 hexagon head screw S 150/Z (M10)
and 1 washer S 4330/40
for extrusion S 100
1.391 kg

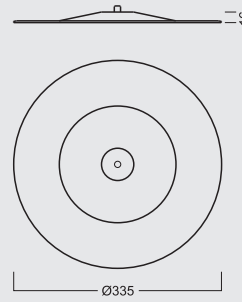
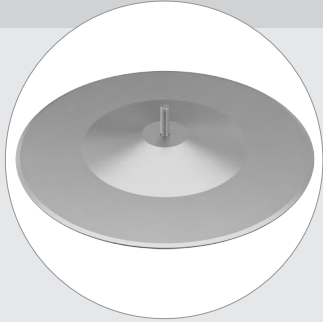

S 150

S 150.21

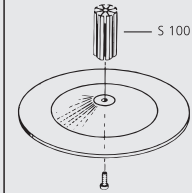

INTERMEDIATE WASHER

aluminium
with thread M10, to adjust the height of
S 150 to the height of an adjustable foot
0.018 kg

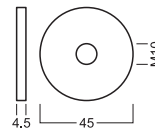

S 151

S 151.01

ACCESSORIES

BASE PLATES

BASE PLATE 335 MM DIA.

steel
incl. adaptor and
1 hexagon screw S 150/Z (M10)
for all square and round extrusions **60 mm**
except for S 800 series
2.53 kg

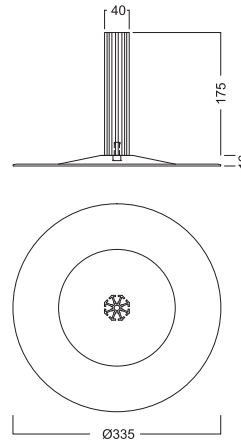
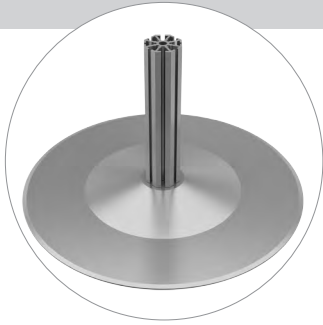

M 1242

M 1242.21

BASE PLATE 335 MM DIA.

steel
incl. adaptor DFS 13 and
1 hexagon screw S 150/Z (M10)
for all square and round extrusions **80 mm**
3.262 kg

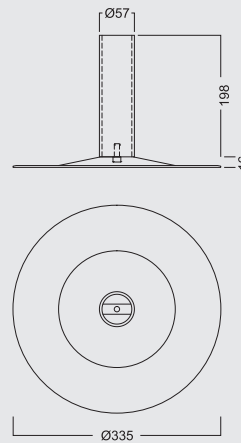
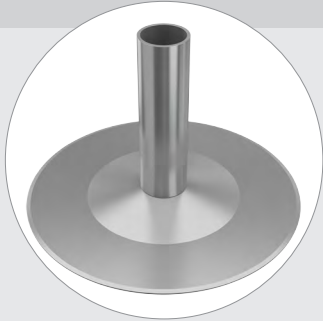

M 1240

M 1240.21

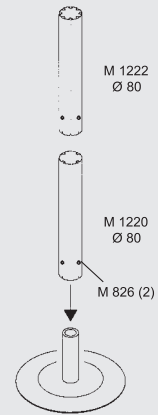

BASE PLATE 400 MM DIA.

steel
incl. adaptor DFS 13 and
1 hexagon screw S 150/Z (M10)
for all square and round extrusions **80 mm**
6.03 kg

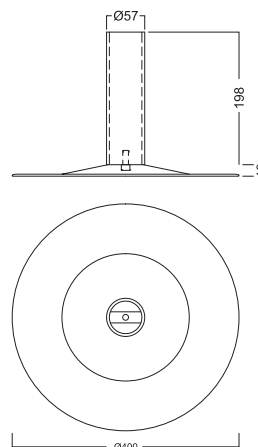
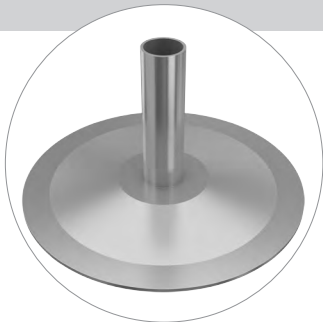

M 1239

M 1239.21

ACCESSORIES

BASE PLATES

BASE PLATE 455 MM DIA.

steel
incl. adaptor DFS 13 and
1 cylinder screw M 825/20 (M10)
for all square and round extrusions **80 mm**
7.406 kg

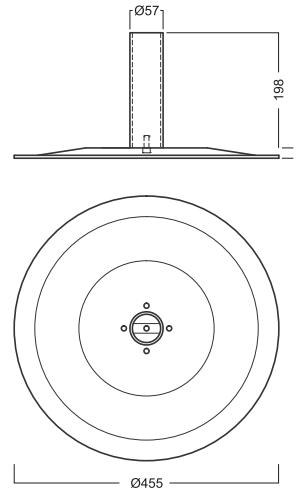
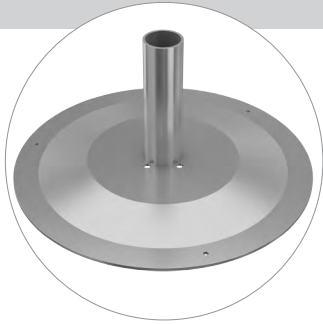

M 1238

M 1238.21

BASE PLATE 455 MM DIA.

steel
incl. adaptor M 825/A and
4 cylinder screws M 825/20 (M10)
for all square extrusions **120 mm** and
all **closed** round extrusions
120 mm dia.
8.142 kg

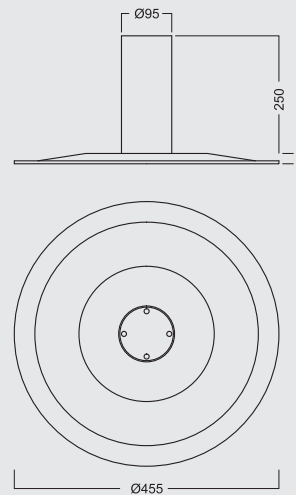
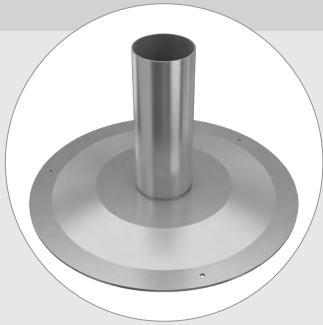

M 825

M 825.21

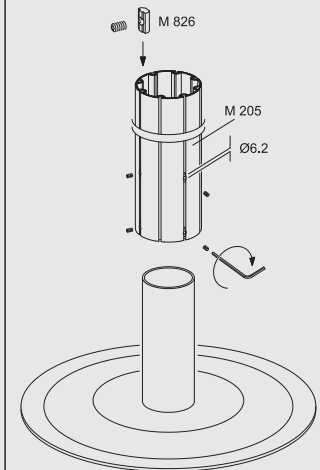

BASE PLATE 455 MM DIA.

steel
incl. adaptor M 115,
4 cylinder screws M 825/20 (M10) and
4 hexagon nuts M 824/30 (M10)
for all **open** round extrusions
120 mm dia.
7.247 kg

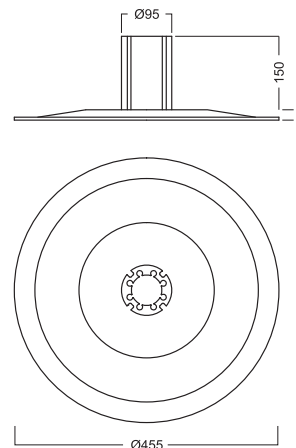
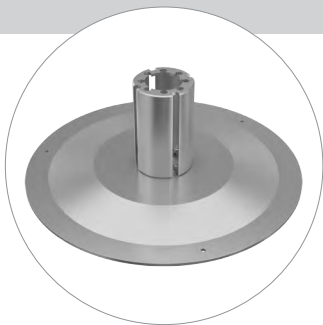

M 824

M 824.21

ACCESSORIES

BASE PLATES

SAFETY STOP

M 826

aluminium
incl. 1 set screw M 826/S (M6)
0.005 kg



M 826.00

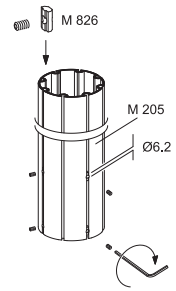

ACCESSORIES

SUPPORT FRAMES

FOOT BRACKET

steel
incl. 1 adjustable foot S 1140 and
2 hammerhead bolts M 1142
for mounting to system groove 4.3 mm
can also be used as shelf bracket for glass
and wooden shelves
0.792 kg

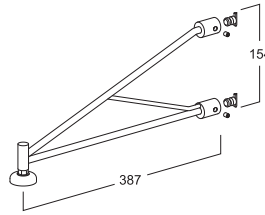
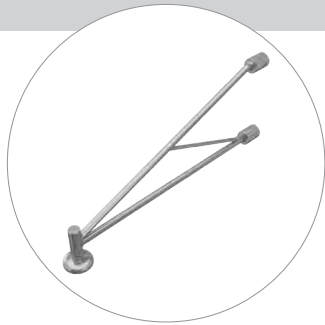

M 1402

M 1402.21

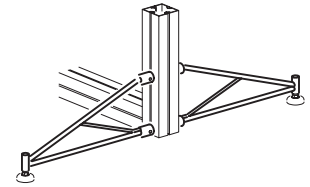

GLASS SUPPORTING SET

steel/rubber
to support glass in connection with M 1402
0.014 kg

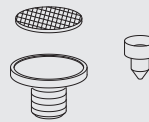
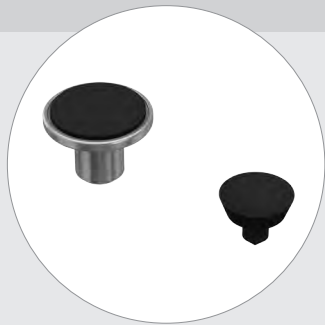

M 1402/Z

M 1402/Z.50

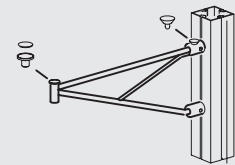

maximum load 40 kg
Belastbarkeit max. 40 kg

FOOT BRACKET

steel
incl. 1 adjustable foot S 1140,
2 hammerhead bolts M 1142 and
2 threaded sleeves M 1445/1
for mounting to system groove 4.3 mm
1.02 kg

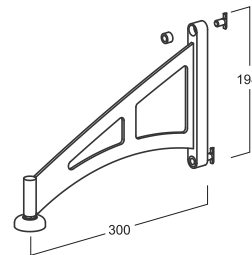
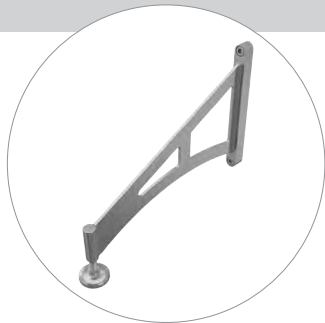

M 1404

M 1404.21

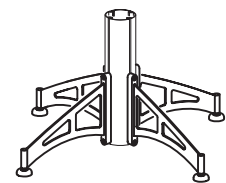

FOOT BRACKET

acrylic, opaque
incl. mounting parts M 1411/Z (M8)
3.68 kg

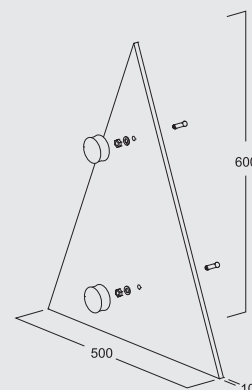

M 1411

M 1411.90

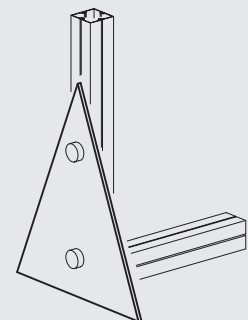

ACCESSORIES

SUPPORT FRAMES

PEDESTAL BASE 425 MM

steel
incl. supporting peg S 166,
1 countersunk screw S 146/20 (M10) and
1 countersunk screw E 111/m (M6)
for upright extrusions M 1000, S 108 ...
with 2 female threads M10 at bottom
for mounting castors or adjustable feet
1.364 kg

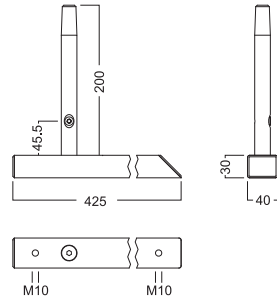

S 144

S 144.90

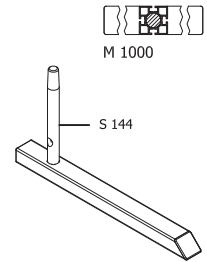

PEDESTAL BASE 700 MM

steel
incl. supporting peg S 166,
1 countersunk screw S 146/20 (M10) and
1 countersunk screw E 111/m (M6)
for upright extrusions M 1000, S 108 ...
with 2 female threads M10 at bottom
for mounting castors or adjustable feet
1.895 kg

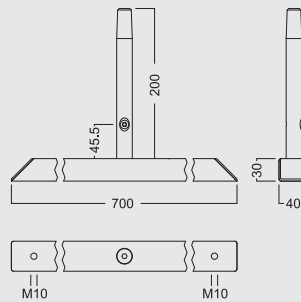

S 146

S 146.90

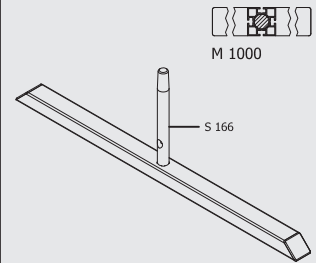

PEDESTAL BASE

aluminium
incl. 1 cylinder screw M10 for S 100
in conjunction with threaded plug S 137/K
for S 108 and S 201
2.23 kg

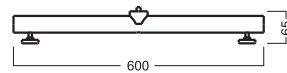

S 142

S 142.11

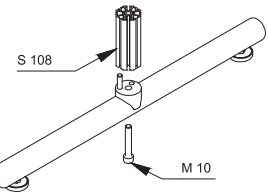

ACCESSORIES

WARDROBE SYSTEMS

CLOTHES ROD EXTRUSION

aluminium
with grey plastic slide on the top of the rail
for coat hangers
tension lock Z 961/13 can be mounted
5000 mm long
4.3 kg



E 800

E 800.01
E 800.11

CLOTHES ROD BRACKET

steel
to attach E 800 between wooden panels
0.021 kg

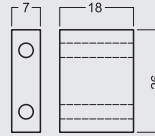
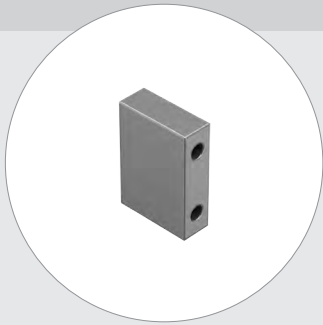

E 804

E 804.37

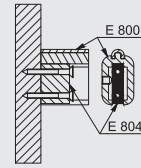

CLOTHES ROD

aluminium
incl. 2 built-in tension locks Z 961/13
950 mm long
0.977 kg

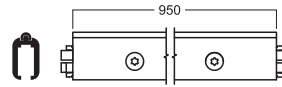

E 810

E 810.11

CLOTHES ROD

aluminium
incl. 2 built-in tension locks Z 961/13
974 mm long
0.98 kg

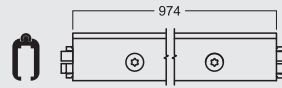

E 811

E 811.11

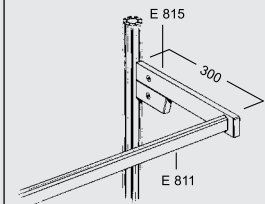

COAT HANGER BEAM

aluminium
incl. 2 built-in tension locks Z 961/13 and
milled slot for mounting E 811
maximum load 35 kg
325 mm long
0.398 kg

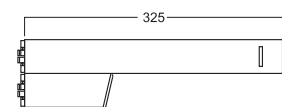

E 815

E 815.11

ACCESSORIES

WARDROBE SYSTEMS

COAT HANGER BEAM

aluminium
incl. built-in tension locks 1 Z 951/13 and
1 Z 961/13
mountable between 2 upright extrusions
for **990 mm axis**
0.804 kg

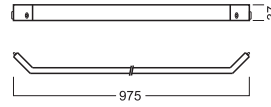

E 280

E 280.11

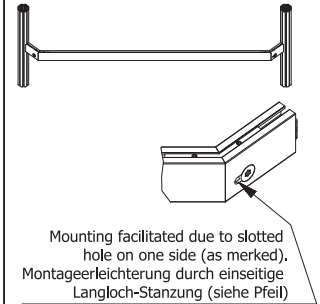

COAT HOOK

aluminium
to slide on coat hanger beam E 280
0.021 kg

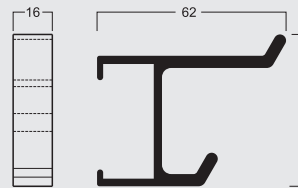

E 284

E 284.01

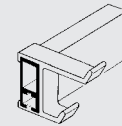

COAT HOOK

aluminium
to be hooked on coat hanger beam E 280
0.062 kg

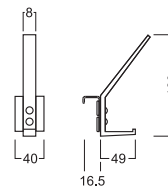

E 281

E 281.01

FRONT SUSPENSION BAR

steel
incl. hammerhead bolt M 1142
and set screw E 111/6*6 (M6)
for mounting to system groove 4.3 mm
maximum load 15 kg
0.374 kg

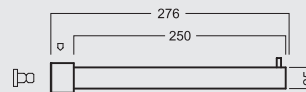

M 1582

M 1582.21

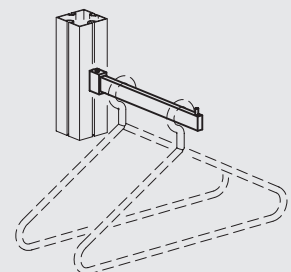

WARDROBE SYSTEMS

FRONT SUSPENSION
BAR - STAIRSHAPE

steel
incl. hammerhead bolt M 1142
and set screw E 111/6*6 (M6)
for mounting to system groove 4.3 mm
maximum load 15 kg
0.544 kg

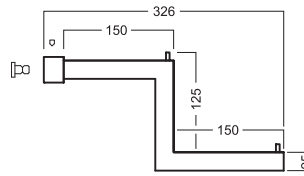
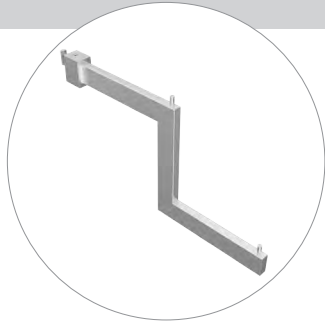

M 1584

M 1584.21

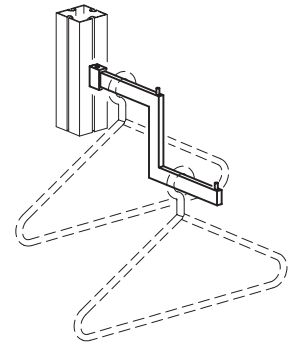

ACCESSORIES

LIGHTING AND ELECTRIC

LONG-ARM FLOODLIGHT

aluminium diecast
with halogen light 120 W / 230 V
and cable plug 3000 mm
0.85 kg

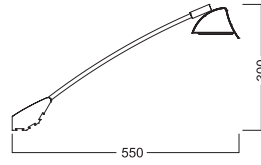

M 1480

M 1480.31

CLAMP FOR LONG- ARM FLOODLIGHT

aluminium
for installation in 4.3 mm system groove
(extrusion top face)
can be used in combination with
long-arm spot light M 1480, M 1499
0.014 kg

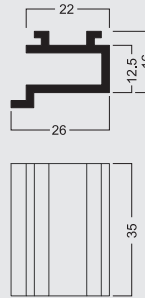

M 1481

M 1481.01

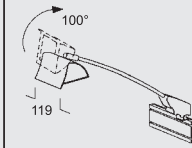

CLAMP FOR LONG- ARM FLOODLIGHT

aluminium
for M 1480
for mounting to system groove 4.3 mm
(lateral groove of extrusion)
0.032 kg

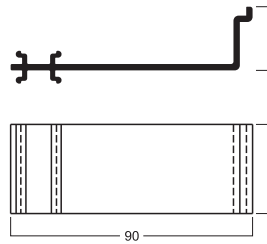

M 1482

M 1482.01

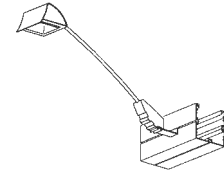

LED LONG-ARM FLOODLIGHT WITH ADAPTOR

aluminium, diecast body, silver grey
12 W / 230 V , 4000 K
intergrated transformer
bolted safety glass
cable with flat plug, 3000 mm long
and clamp M 1481
0.614 kg

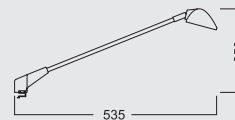

M 1498

M 1498.31

ACCESSORIES

LIGHTING AND ELECTRIC

LOW VOLTAGE SPOTLIGHT

metal moulded body, nickel-plated
two parts, fully isolated from aluminium
extrusion
2 m teflon wire
adjustable in height with knurled knob
for bulb max. 50 W / 12 V, Ø 50 mm
0.13 kg

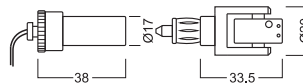

D 1145

D 1145.90

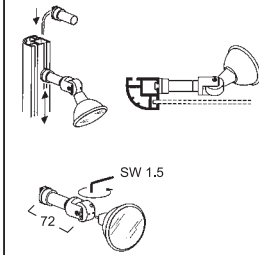

DOUBLE FLUORESCENT LIGHT

sheet steel
incl. 2 sockets, 1.8 m cable with plug,
with hook to suspend on beams
for tubes 2 x 30 W, 230 V
4 kg

D 171

D 171.20

ELECTRIC DISTRIBUTION BOX

insulated case (polyamide), grey
with grounded circuit breaker 4/40/0.03A
1 CEE plug 5/16 amp., 380 V with
automatic safety cut-out, 3/16 A,C
8 sockets 230 V with automatic safety
cut-out, 1/16 A,B
thereof:
1 refrigerator socket (red) with separate
supervisory lamp (red)
1 computer socket (blue) with separate
supervisory lamp (blue)
6 sockets (black)
1 additional ground screw with butterfly nut
1 cable inlet with traction relief, fully wired
loosely attached: 2 pcs. E 220 incl.
setscrews and nuts for suspension in front
of wall elements
8.74 kg

D 208/N

D 208/N.90

ELECTRIC DISTRIBUTION BOX

insulated case (polyamide), grey
with grounded circuit breaker 4/40/0.03A
1 CEE plug 5/16 amp., 380 V with automatic
security cut-out
16 sockets with ground contact, grey, 230 V
with autom. security cut-outs
of which: 1 refrigerator socket (blue)
1 additional ground screw with butterfly nut
loosely attached: 2 pcs. E 220 incl. set
screws and nuts for suspension in front of
wall elements
10.71 kg

D 216

D 216.90

ACCESSORIES

MONITOR SUPPORT SYSTEMS

ADAPTOR FOR MONITOR 15" - 21"

aluminium
incl. mounting material
with 8 boreholes 5 mm dia.
for LCD screens 15", 17", 19", 21"
120 x 120 x 16 mm
0.558 kg

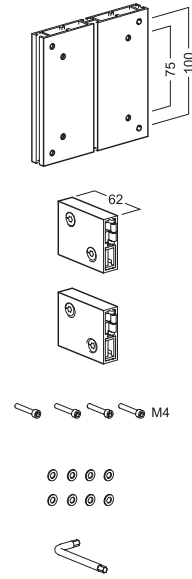

E 185

E 185.01

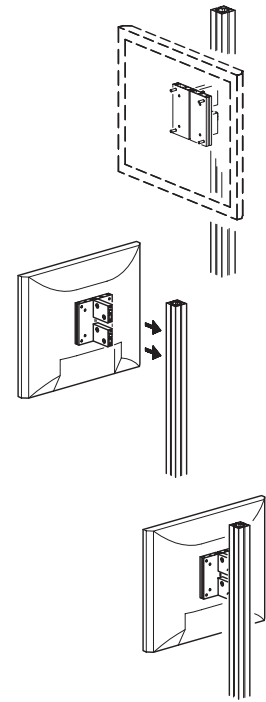

ADAPTOR FOR MONITOR 15" - 21"

aluminium
incl. fixing screws M4
with 8 boreholes 5 mm dia.
for LCD screens 15", 17", 19", 21"
without beams
120 x 120 x 16 mm
0.265 kg

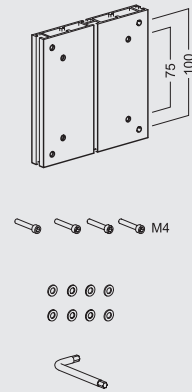
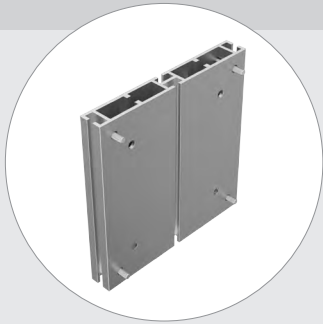

E 186

E 186.01

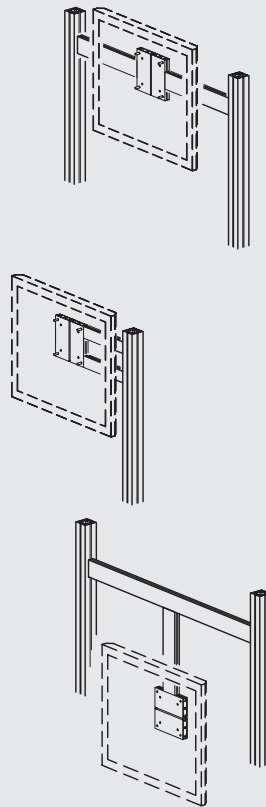

ACCESSORIES

MONITOR SUPPORT SYSTEMS

ADAPTOR FOR MONITOR 20" - 32"

steel / plastic
set including:
1 mounting plate with universal hole pattern,
1 hinged connector element with pin interlock,
2 end caps M 1278
for connection to upright extrusion with system groove 4.3 mm
monitor can be mounted straight or at an angle of 15°
for LCD screens 20" - 32"
1.75 kg

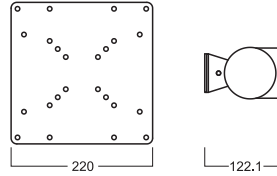

E 188

E 188.21

MONITOR FIXING SET

aluminium/steel
set including:
1 beam extrusion M 1340, 973 mm long, incl. 4 tension locks Z 961/13,
2 mounting brackets with universal slots and mounting hardware
for attachment to standard upright extrusions with system groove 4.3 mm
mountable between 2 upright extrusions
for 990 mm axis
monitor can be mounted straight or at an angle of 8° max.
for LCD screens 32" - 52"
8 kg

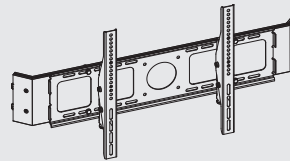

E 191

E 191.90

MONITOR FIXING SET

aluminium/steel
set including:
1 beam extrusion M 1340, 770 mm long, incl. 4 tension locks Z 961/13,
2 mounting brackets with universal slots and mounting hardware
for attachment between two uprights with system groove 4.3 mm
for one sided monitor solutions
monitor can be mounted straight or at an angle of 8° max.
for LCD screens 36" - 52"
7.35 kg

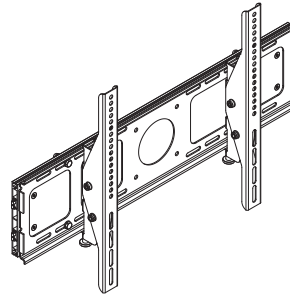

E 195

E 195.90

ACCESSORIES

MONITOR SUPPORT SYSTEMS

MONITOR POLE SET 20" - 32"

aluminium / steel
 set including:
 1 square upright extrusion M 1012 (80 mm),
 1750 mm long, divided
 1 cross leg element with 4 adjustable feet
 2 beam extrusions Z 600, 340 mm long,
 incl. 2 tension locks Z 961/13,
 2 mounting brackets with universal slots
 and mounting hardware
 incl. transport case K 0012;
 monitor can be mounted straight or at an
 angle of 12° max.
for LCD screens 20" - 32"
 27.5 kg

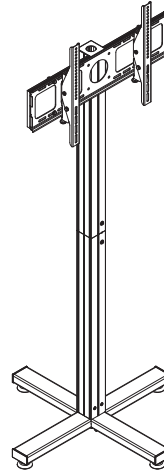

VA 5514

VA 5514.90

MONITOR POLE SET

aluminium/steel
 set including:
 2 square uprights M 1018 (80 mm),
 1750 mm long
 2 base plates VA 5524/1, 300 x 500 mm
 1 monitor fixing set E 195
 1 beam Z 400, 770 mm long, incl. 2 tension
 locks Z 961/13
for monitor mounted on one side
 monitor can be mounted straight or at an
 angle of 8° max.
for LCD screens 36"-52"
 35.85 kg

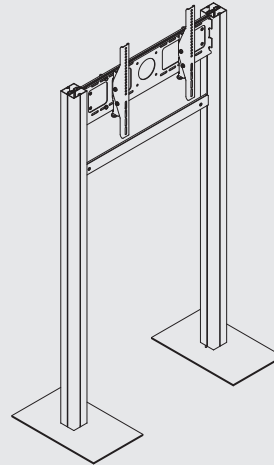
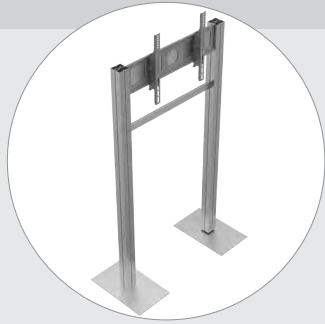

VA 5524

VA 5524.90

ACCESSORIES

LITERATURE RACKS

LITERATURE RACK

steel
4 partitions for size 238 x 300 mm, incl.
glass front
to suspend on upright extrusions S 100,
S 108 and beams
Attention: Axis measurement 990 mm
7 kg

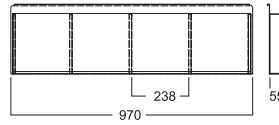
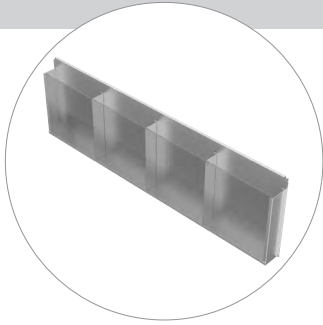

E 286

E 286.21

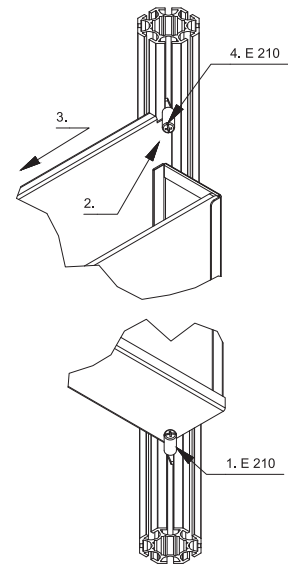

LITERATURE DISPENSER

steel
4 mm dia., incl. mounting parts M8
for size DIN A4, 45°
edge height 50 mm
maximum load 2.5 kg
0.506 kg

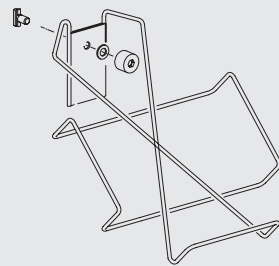
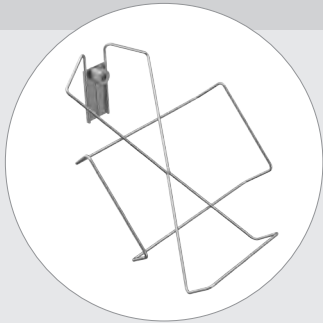

E 277

E 277.21

BROCHURE SHELF UNIVERSAL

sheet steel, RAL 9006
swiveling,
incl. mounting parts
0.91 kg

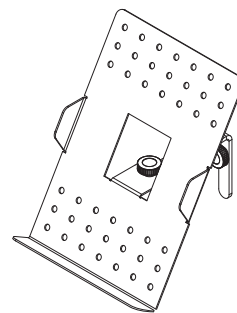
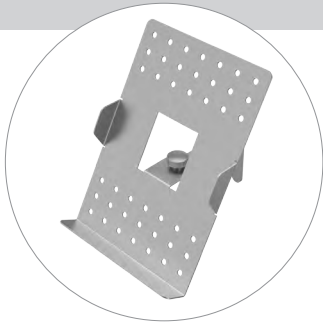

VA 1240

VA 1240.90

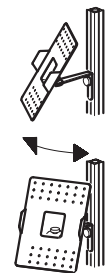

ACCESSORIES

LITERATURE RACKS

BROCHURE SHELF, LEFT

sheet steel
incl. mounting parts
0.549 kg

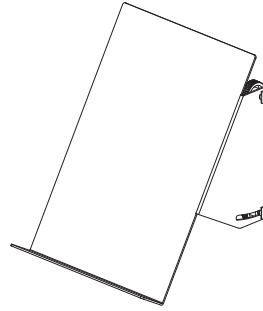

VA 5036

VA 5036.21

BROCHURE SHELF, RIGHT

sheet steel
incl. mounting parts
0.549 kg

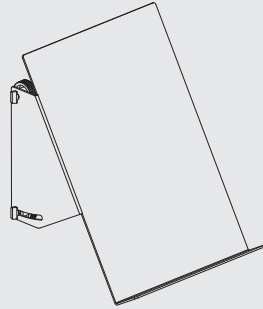

VA 5032

VA 5032.21

DISPLAY SHELF

wood, silver / aluminium
beam incl. built-in tension lock Z 961/13
for system groove 4.3 mm
0.89 kg

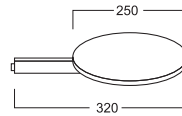
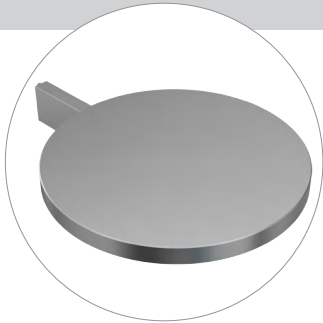

VA 5076

VA 5076.90

DISPLAY SHELF RECTANGULAR

wood, white / aluminium
beam incl. 2 built-in tension locks Z 961/13
for system groove 4.3 mm
2.931 kg

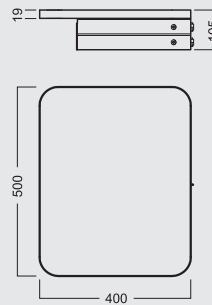
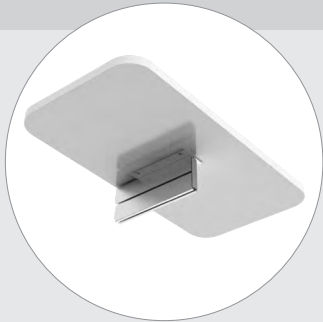

M 1454

M 1454.90

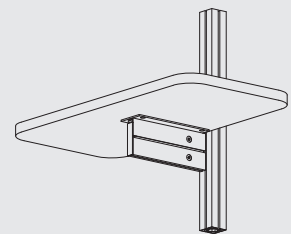

ACCESSORIES

LITERATURE RACKS

LITERATURE RACK

aluminium, matt anodized, silver
literature shelf made of transparent acrylic glass
for 1 DIN A4 compartment
3.84 kg

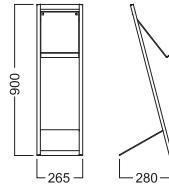
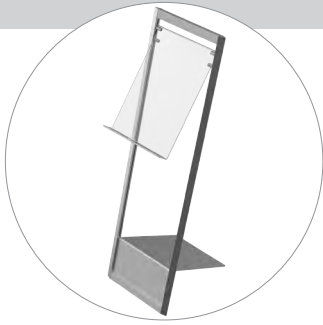

P-1

P-1.90

LITERATURE RACK

aluminium, matt anodized, silver
literature shelves made of transparent acrylic glass
2 DIN A4 compartments
4.43 kg

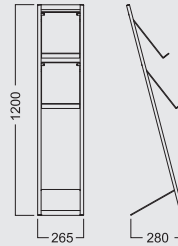
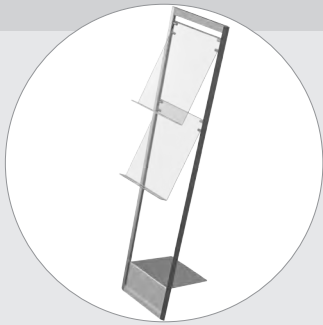

P-2

P-2.90

LITERATURE RACK

aluminium, matt anodized, silver
literature shelves made of transparent acrylic glass
3 DIN A4 compartments
4.88 kg

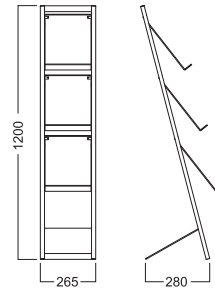
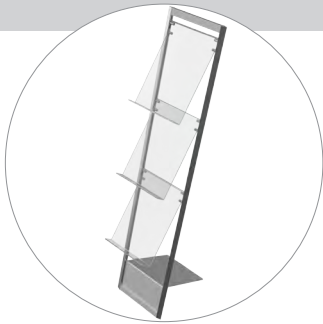

P-3

P-3.90

LITERATURE RACK

aluminium, matt anodized, silver
literature shelves made of transparent acrylic glass
4 DIN A4 landscape compartments
5.514 kg

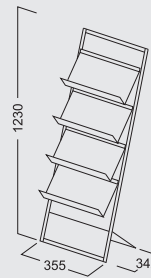

P-4A

P-4A.90

LITERATURE RACK - WALL VERSION

aluminium, matt anodized, silver
literature shelves made of transparent acrylic glass
4 DIN A4 compartments
4.43 kg

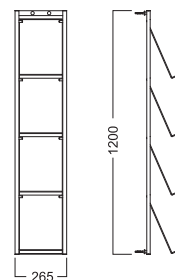

P-4W

P-4W.90

ACCESSORIES

LITERATURE RACKS

LITERATURE RACK

aluminium, matt anodized, silver
literature shelves made of transparent
acrylic glass
6 DIN A4 compartments
7 kg

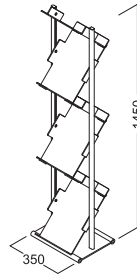
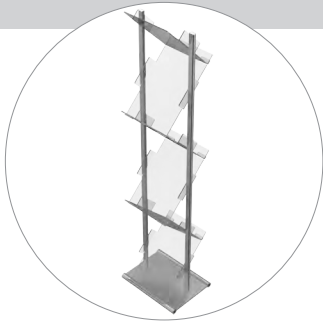

P-ZZ6

P-ZZ6.90

LITERATURE RACK

aluminium, matt anodized, silver
literature shelves made of transparent
acrylic glass
8 DIN A4 compartments
10.68 kg

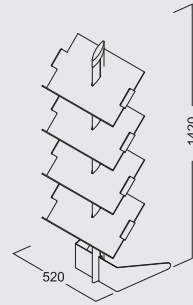
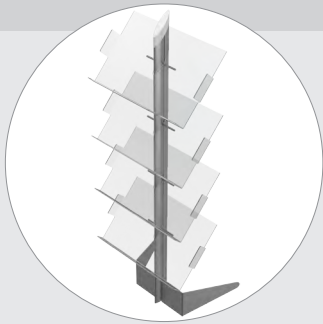

P-8D

P-8D.90

PORTABLE LITERATURE RACK WITH TRANSPORT BAG

shelves: acrylic glass
4 DIN A4 shelves ,
can be pulled in and out without tools,
profiles: aluminium matt anodized
base: sheet steel, grey powder-coated
with transport bag
6.45 kg

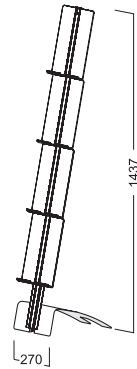
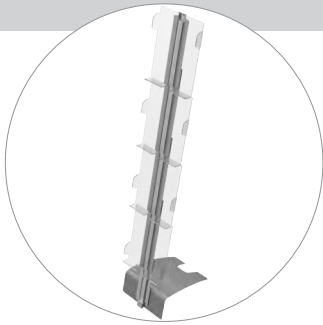

VA 8804PW

VA 8804PW.90

PORTABLE LITERATURE RACK

shelves: acrylic glass
4 DIN A4 shelves ,
can be pulled in and out without tools,
extrusions: aluminium matt anodized
base: sheet steel, grey powder-coated
5.57 kg

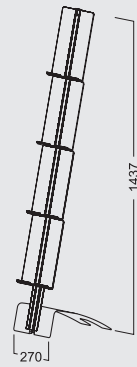
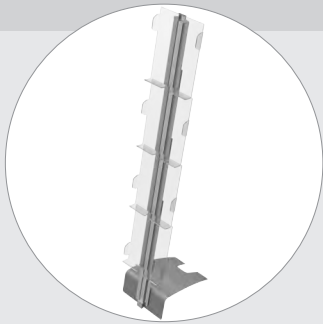

VA 8842

VA 8842.90

ACCESSORIES

LITERATURE RACKS

PORTABLE LITERATURE RACK WITH TRANSPORT BAG

shelves: acrylic glas
8 DIN A4 shelves,
 can be pulled in and out without tools,
 profiles: aluminium matt anodized
 base: sheet steel, grey powder-coated
with transport bag
 9.13 kg

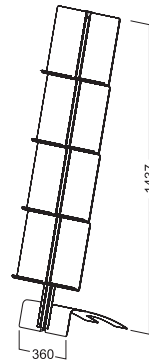
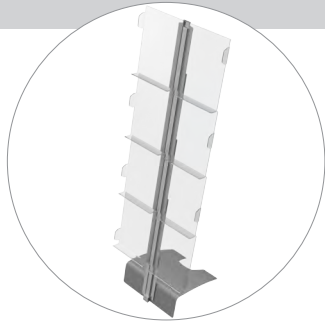

VA 8808PW

VA 8808PW.90

PORTABLE LITERATURE RACK

shelves: acrylic glas
8 DIN A4 shelves,
 can be pulled in and out without tools,
 extrusions: aluminium matt anodized
 base: sheet steel, grey powder-coated
without transport bag
 7.22 kg

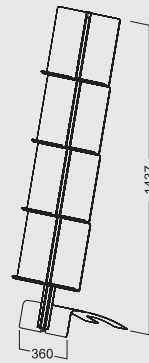
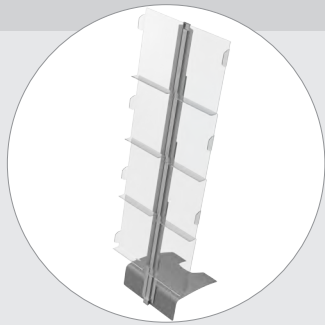

VA 8882

VA 8882.90

TRANSPORT BAG

nylon, green-grey
for VA 8842
 1.27 kg



VA 8834

VA 8834.90

TRANSPORT BAG

nylon, green-grey
for VA 8882
 or 2 pieces base plate M 825
 2.15 kg



VA 8838

VA 8838.90

ACCESSORIES

DOORS

GLASS DOOR SET RIGHT

aluminium / tempered safety glass 8 mm, "clear"
for MAXIMA extrusions
consisting of:
door frame with door seal W 501/Z,
glass door panel W 501/T,
hinge set W 501/TG,
handle and lock set W 501/GS
prepared for dead lock cylinder W 514
assembly dimension 950 x 1960 mm
Attention: additional cut-out is required for locking!
41 kg

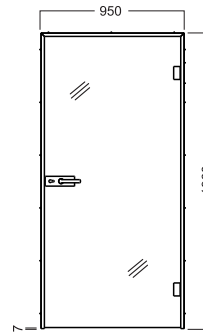

W 501

GLASS DOORS

W 501.01

GLASS DOOR FRAME RIGHT

aluminium
incl 17 threaded plates E 470/E,
17 countersunk screws W 501/21 (M4) and
threshold seal floor
assembly dimension 950 x 1960 mm
3.345 kg

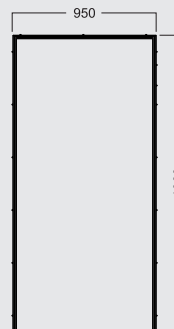
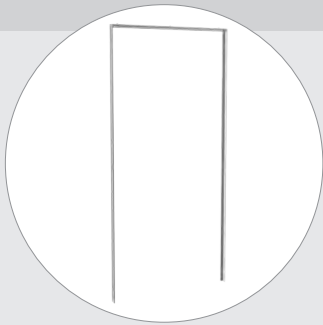

W 501/Z

W 501/Z.01

GLASS DOOR SET LEFT

aluminium / tempered safety glass 8 mm, "clear"
for MAXIMA extrusions
consisting of:
door frame with door seal W 502/Z,
glass door panel W 501/T,
hinge set W 501/TG,
handle and lock set W 501/GS
prepared for dead lock cylinder W 514
assembly dimension 950 x 1960 mm
Attention: additional cut-out is required for locking!
41.855 kg

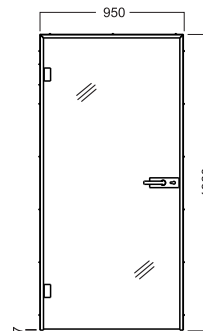

W 502

W 502.01

GLASS DOOR BEAM FRAME LEFT

aluminium
incl. 17 threaded plates E 470/E,
17 countersunk screws W 501/21 (M4) and
threshold seal floor
assembly dimension 950 x 1960 mm
4.2 kg

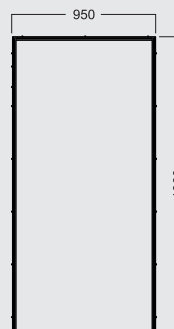
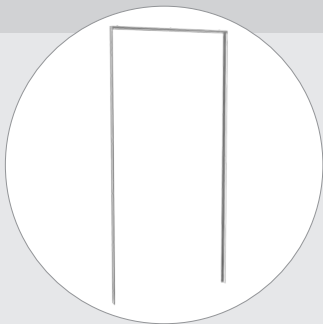

W 502/Z

W 502/Z.01

ACCESSORIES

DOORS

GLASS DOOR PANEL

tempered safety glass 8 mm, "clear"
usable universally left or right
in combination with W 501/Z, W 502/Z
35.8 kg

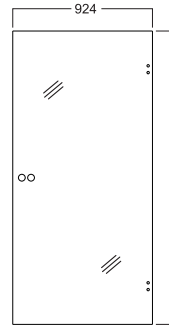
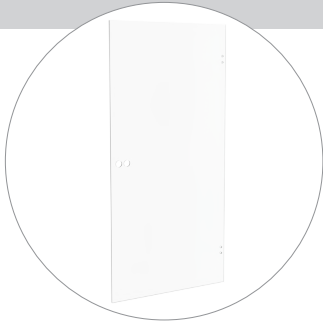

W 501/T

W 501/T.90

HINGE SET

for glass door W 501, W 502
0.518 kg

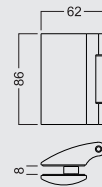

W 501/TG

W 501/TG.01

HANDLE- AND LOCK SET

for glass door W 501, W 502
1.313 kg

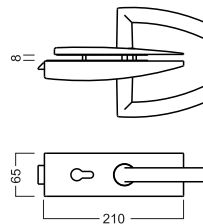

W 501/GS

W 501/GS.01

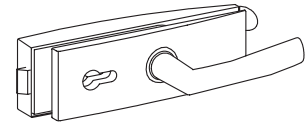

GLASS DOOR SET DIN RIGHT/LEFT

aluminium / tempered safety glass 8 mm,
"clear"
universal usage left/right
for Standard OCTANORM extrusions,
consisting of:
door beam frame W 505/Z, glass door panel
W 505/T, handle- and lock set W 505/GS,
prepared for dead lock W 514
assembly dimension 950 x 2500 mm
51 kg

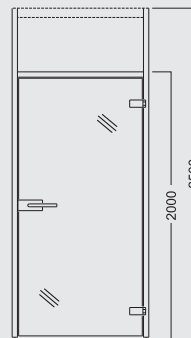

W 505

W 505.90

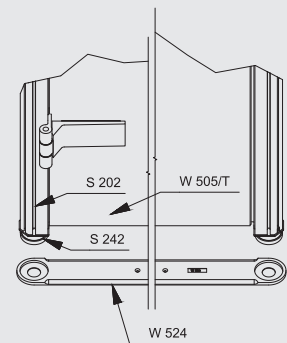

ACCESSORIES

DOORS

GLASS DOOR BEAM FRAME

aluminium
right side, can be changed to door stop
left side, in conjunction with W 505/T
2480 mm long
11.095 kg

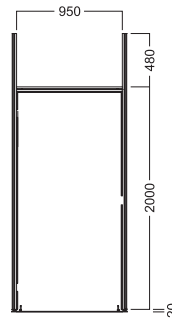

W 505/Z

GLASS DOORS

W 505/Z.11

GLASS DOOR PANEL

tempered safety glass 8 mm, "clear"
universal usage DIN left/DIN right
in conjunction with W 505/Z
37 kg

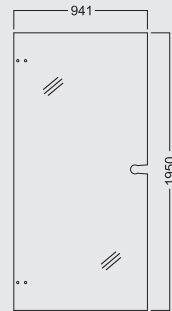
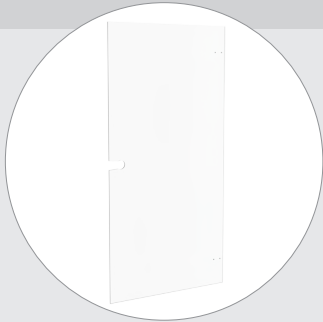

W 505/T

W 505/T.90

HINGE SET

for full glass door W 505
0.929 kg

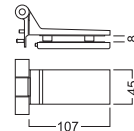

W 505/TG

W 505/TG.01

HANDLE- AND LOCK SET

for full glass door W 505
1.46 kg

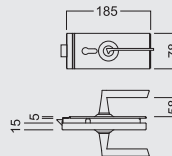
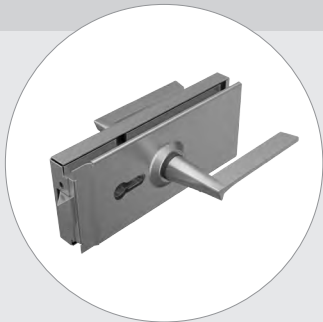

W 505/GS

W 505/GS.01

ACCESSORIES

DOORS

DOOR FRAME, UNIVERSAL

aluminium
right side, can be changed to door stop left side
in conjunction with W 510/T
assembly dimension 950 x 2000 mm
5.608 kg

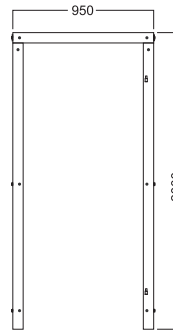
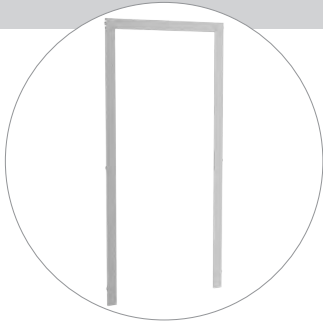

W 510/Z

STANDARD DOORS

W 510/Z.11

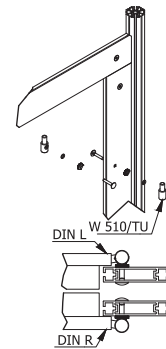

DOOR PANEL RIGHT

coated, white RAL 9010
incl. mortice lock W 513/R and door handle set W 512
prepared for dead lock cylinder W 514
used in conjunction with W 510/Z
15.19 kg

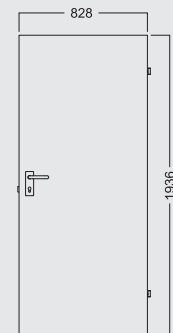

W 510/T

W 510/T.30

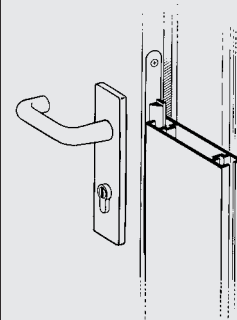

DOOR PANEL LEFT

coated, white RAL 9010
incl. mortice lock W 513/L and door handle set W 512
prepared for dead lock cylinder W 514
used in conjunction with W 510/Z
15.09 kg

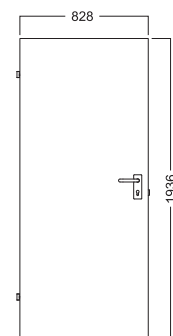

W 511/T

W 511/T.30

7

DOOR FRAME, UNIVERSAL

aluminium
right side, can be changed to door stop left side
to be used in conjunction with W 580/T and W 581/T
incl. threshold seal W 585
assembly dimension 950 x 2030 mm
4.669 kg

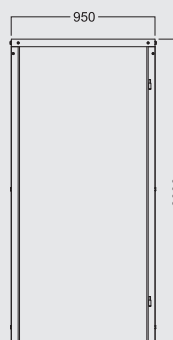

W 580/Z

W 580/Z.01

ACCESSORIES

DOORS

DOOR PANEL RIGHT

painted, white RAL 9010
 incl. skeleton key mortise lock with 1 key,
 to be used in conjunction with W 580/Z and
 door handle set W 582
 can be changed with PZ mortise lock
 W 513/R and door handle set W 584PZ
 (door handle set not included)
 15 kg

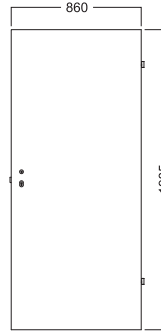

W 580/T

STANDARD DOORS

W 580/T.30

DOOR PANEL LEFT

varnished, white RAL 9010
 incl. skeleton key mortise lock with 1 key
 to be used in conjunction with W 580/Z and
 door handle set W 582
 can be changed with PZ mortise lock
 W 513/L and door handle set W 584PZ
 (door handle set not included)
 15 kg

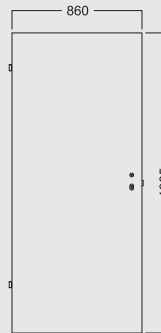

W 581/T

W 581/T.30

THRESHOLD SEAL

plastic
 5000 mm
 0.1 kg



W 585

W 585.30

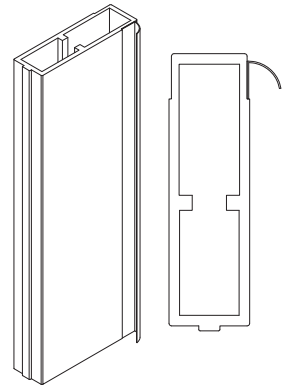

DOOR HANDLE SET

plastic
 for door plate W 580/T and W 581/T
 with rosette and fixing screws for
 a skeleton key mortise lock
 0.308 kg

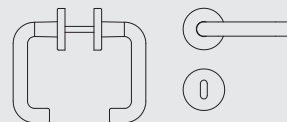

W 582

W 582.30

ACCESSORIES

DOORS

DOOR HANDLE SET

plastic
for door plate W 580/T and W 581/T
with rosette and fixing screws for profile
cylinder lock
0.309 kg

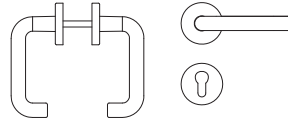

W 584PZ

W 584PZ.30

DRILLING JIG

plastic
for door handle set W 582 and W 548PZ at
door leaf W 580/T and 581/T
without drill (dia. 7 mm)
0.056 kg

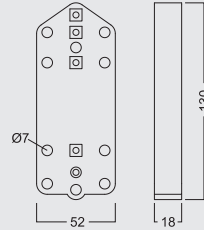

W 599

W 599.33

DOOR HANDLE SET

plastic
for door panels W 510/T and W 511/T
incl. door plate and fixing screws
0.46 kg

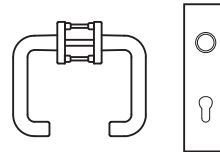

W 512

W 512.30

MORTISE LOCK DIN LEFT

for door panel W 511/T and W 581/T
for dead lock cylinder
0.795 kg

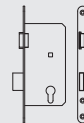

W 513/L

W 513/L.00

ACCESSORIES

DOORS

MORTISE LOCK DIN RIGHT

for door panel W 510/T and W 580/T
for dead lock cylinder
0.795 kg

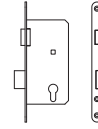

W 513/R

STANDARD DOORS

W 513/R.00

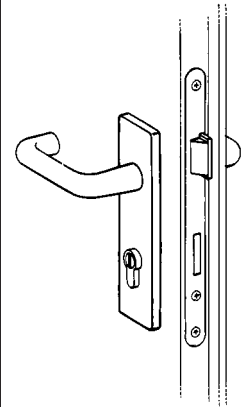

DEAD LOCK CYLINDER

steel
supplied with 3 keys W 514/S
0.222 kg

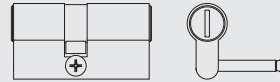

W 514

W 514.38

THRESHOLD PLATE

steel
for door frames W 505, W 510/Z and
W 580/Z
for axis measurement 990 mm
1.77 kg

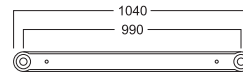
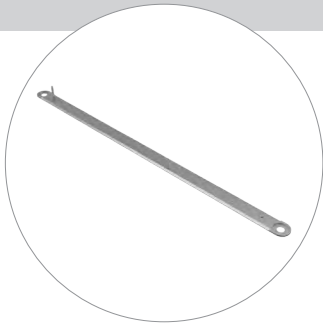

W 524

W 524.37

ADD-ON THRESHOLD PLATE

steel
for mounting to W 524
for axis measurement 990 mm
1.7 kg

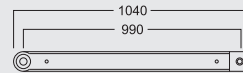
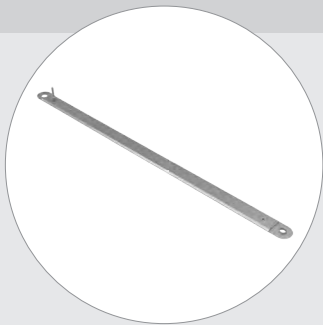

W 524/A

W 524/A.37

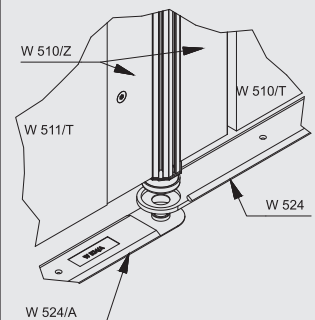

ACCESSORIES

DOORS

FOLDING DOOR

imitation leather
for standard OCTANORM extrusions
for axis measurement 990 mm
21.43 kg

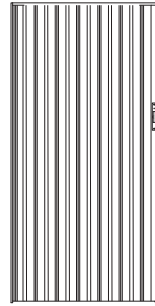

W 525

W 525.30

KIT FOR BEAM DOOR FRAME

aluminium
right
incl. mortise lock and door handle set,
prepared for dead lock cylinder W 514
without fillings
assembly dimension 950 x 1930 mm
10.953 kg

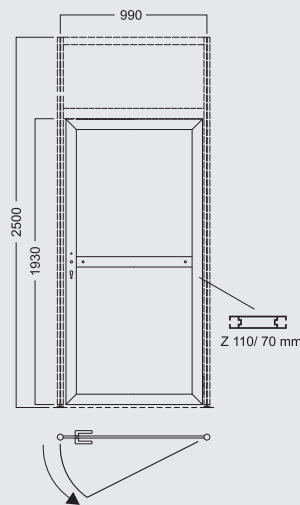

W 540

W 540.01
W 540.11

KIT FOR BEAM DOOR FRAME

aluminium
left
incl. mortise lock and door handle set,
prepared for dead lock cylinder W 514
without fillings
for axis measurement 990 mm
assembly dimension 950 x 1930 mm
10.915 kg

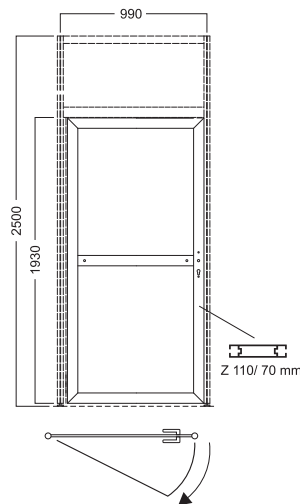

W 541

W 541.01
W 541.11



Pneumatic press
336



Tools
339



Drilling Jigs and Drills
345



Drilling Jigs and Drills | Drill Guide Bushes
349

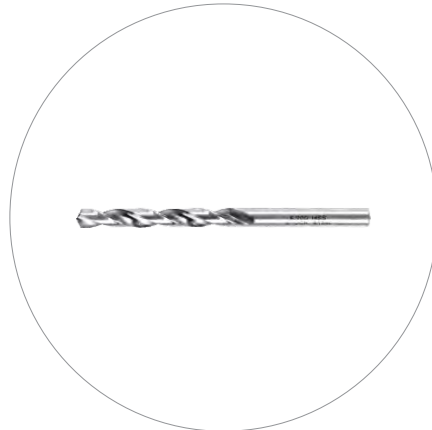

Drilling Jigs and Drills | Twist Drills
350



Drilling Jigs and Drills | Countersinks
351



Drilling Jigs and Drills | Step Drill
352



Drilling Jigs and Drills | Handtap Drill
353



Transport cases
354



Transport cases | For Beam 37 mm
354



Transport cases | For Curved Beams 37 mm
354



Transport cases | For Beams 50 mm
355



Transport cases | For Curved Beams 50 mm
355



Transport cases | For Beams 70 mm
356



Transport cases | For Curved Beams 70 mm
356



Transport cases | For Beams 175 mm
357



Transport cases | For Curved Beams 175 mm
358



Transport cases | Universal box
358



Transport cases | Inner Partitions
358



Transport cases | Transport Protection
360

PNEUMATIC PRESS

PNEUMATIC PRESS

for 13 mm system punching in beams and uprights for fitting tension lock Z 961/13
 working pressure 6-10 bar
 air supply connection 3/8" (=6 mm)
 air consumption 6 bar = 0.44 l
 10 bar = 0.70 l

basic equipment:
 interchangeable sub-press WPS 1, incl. fixing screws, key and cover set PS-00
 press body with base plate, air connection union and foot-operated control valve
 with nylon supporting block set ZPS 107 for different extrusion thickness, for fixing on punch positions A and B
 52.5 kg

PS-0

PS-0.90



INTERCHANGEABLE SUB-PRESS

interchangeable sub-press fitted with punch and mandrel for 13 mm system drilling
 for fitting tension locks Z 961/13 in beam extrusions with small and large tension lock hollow section
 4.76 kg

WPS 1

WPS 1.90

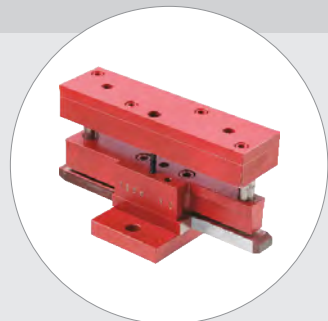

INTERCHANGEABLE SUB-PRESS

interchangeable sub-press fitted with punch and mandrel for 8 mm system drilling and countersinking for fitting knuckle joints in extrusions with 14 mm square hollow section by using countersunk screws E 111/m
 4.9 kg

WPS 2

WPS 2.90

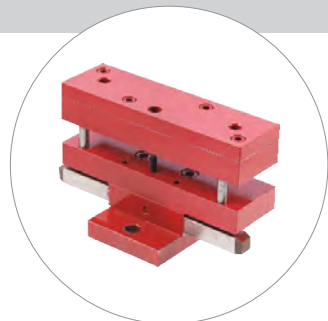

INTERCHANGEABLE SUB-PRESS

interchangeable sub-press fitted with punch and mandrel for 8 mm system drilling
 for fitting tension locks Z 961/8 in upright extrusions
 4.27 kg

WPS 5

WPS 5.90

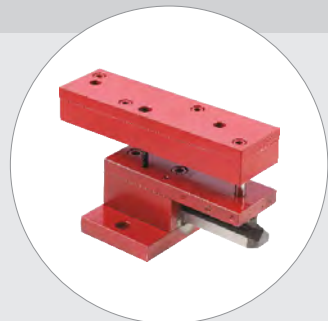

TOOLS, TRANSPORT

PNEUMATIC PRESS

FOOT-OPERATED CONTROL VALVE

for pneumatic press PS-0
0.685 kg



ZPS 100

ZPS 100.90

REPLACEMENT MANDREL 21/13

for interchangeable sub-press WPS 1
suitable for small tension lock hollow
section
0.185 kg



ZPS 101

ZPS 101.90

REPLACEMENT MANDREL 39/13

for interchangeable sub-press WPS 1
suitable for large tension lock hollow
section
0.454 kg



ZPS 102

ZPS 102.90

PUNCH

diameter 13 mm
for interchangeable tool WPS 1
0.065 kg



ZPS 103

ZPS 103.90

PUNCH

diameter 8 mm
for interchangeable tool WPS 2
0.023 kg



ZPS 105

ZPS 105.90

PNEUMATIC PRESS

SET OF NYLON SUPPORTING BLOCKS

nylon, incl. mounting parts
for PS-0
0.54 kg

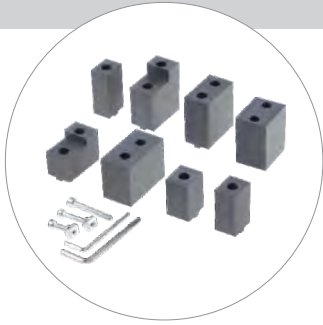

ZPS 107

ZPS 107.90

SUPPORTING BLOCK

nylon, incl. mounting parts
for WPS 1/punch position A
and WPS 7/punch position A
for all 16 mm beam extrusions
0.029 kg



ZPS 107/11

ZPS 107/11.90

SUPPORTING BLOCK

nylon, incl. mounting parts
for WPS 1/punch position A
for S 1310, Z 2100, Z 2105
0.041 kg



ZPS 107/13

ZPS 107/13.90

SUPPORTING BLOCK

nylon, incl. mounting parts
for WPS 1/punch position B
for all 16 mm beam extrusions
0.077 kg



ZPS 107/14

ZPS 107/14.90

SUPPORTING BLOCK

nylon, incl. mounting parts
for WPS 5/punch position A
for M 1201, M 1202, M 1204, S 108, S 201,
S 208
0.07 kg



ZPS 107/51

ZPS 107/51.90

TOOLS, TRANSPORT

TOOLS

HEX-STAR DRIVER

plastic/steel
hex-star T30
 0.059 kg



E 13

E 13.90



HEX-STAR DRIVER T30

wrench
hex-star T30
 0.039 kg



E 14

E 14.90

HEX-STAR DRIVER T30

plastic/steel
hex-star T30
 0.122 kg



E 113

E 113.90

HEX-STAR WRENCH

steel
hex-star T30
 0.02 kg

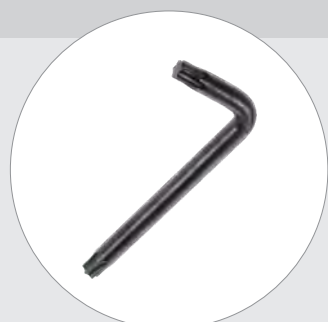

E 114

E 114.90

RATCHET 1/4"

steel
1/4"
 0.097 kg



E 115

E 115.90

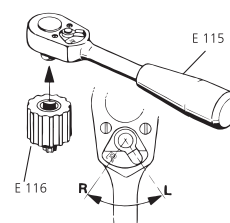

TOOLS, TRANSPORT

TOOLS

HEX-STAR HEAD ATTACHMENT 1/4", T30

plastic/steel
for E 115, hex-star T30
0.019 kg



E 116

E 116.90

HEX-STAR HEAD ATTACHMENT 1/4", T30

steel
hex-star T30 , for Z 961/8
0.021 kg



E 116/42

E 116/42.90

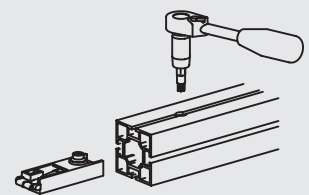

HEXAGON WRENCH SET

steel
set 2, 3, 4, 5 mm
4 pieces in total
0.02 kg

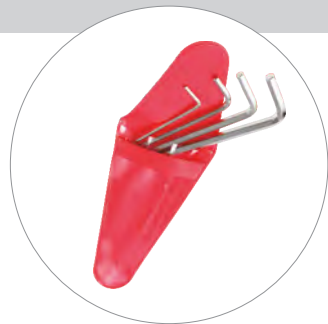

E 117

E 117.90

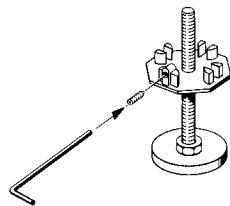

OPEN ENDED SPANNER

steel
A/F 9, 13, 17 mm
0.151 kg



E 119

E 119.90

SCREWDRIVER SET

plastic/steel
1 wrench, 1 ball head screw driver,
A/F 3 mm for setscrew E 111/g
0.046 kg

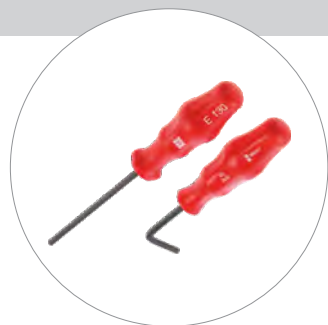

E 130

E 130.90

TOOLS, TRANSPORT

TOOLS

HEXAGON SCREWDRIVER

plastic/steel
A/F 2 mm for setscrew M4
 0.019 kg



E 131

E 131.90

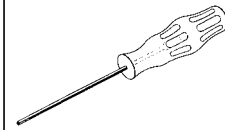

HEXAGON SCREWDRIVER

plastic/steel
A/F 4 mm for E 210/M8
 0.032 kg



E 132

E 132.90

MOUNTING TOOL SET

tool set in a bag consisting of:
 1 ratchet 1/2",
 1 socket wrench 1/2" each with A/F 6 mm,
 A/F 8 mm, A/F 10 mm,
 1 socket wrench extension 250 mm long,
 1/2",
 2 double open ended wrenches similar to
 DIN 895, A/F 17 mm, A/F 24 mm,
 1 hexagon wrench (allen key) A/F 6,
 DIN 911, 210 mm long
 1 hexagon socket wrench each with A/F 13,
 A/F 19
 1 combination wrench A/F 19
 1 OCV meter stick, 3 m long
 2.035 kg

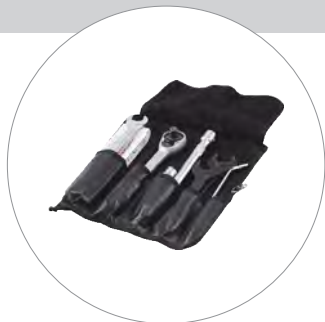

M 900

M 900.90

HEX-STAR DRIVER T30

plastic/steel
 with interchangeable **hex-star head T30**
 and **hexagon head A/F 6 mm**
 0.1 kg



M 940

M 940.90

TOOLS, TRANSPORT

TOOLS

HEX-STAR HEAD ATTACHMENT 1/4", T30

steel
hex-star T30, 1/4"
 0.024 kg



M 945

M 945.90

T-HANDLE SCREWDRIVER

plastic/steel
hex-star T30
 0.074 kg



M 951

M 951.90

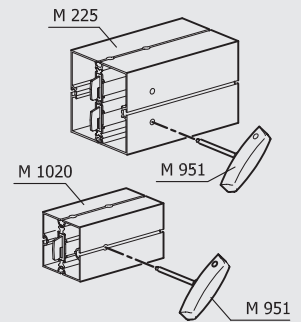

T-HANDLE SCREWDRIVER

plastic/steel
hex-star T30
 0.086 kg



M 952

M 952.90

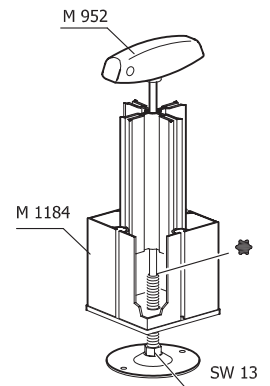

TOOLS, TRANSPORT

TOOLS

**DOUBLE BOX
RATCHETING WRENCH**

steel
A/F 19
for quick foot adjustment
(adjustable foot M16)
0.151 kg

M 955

M 955.90

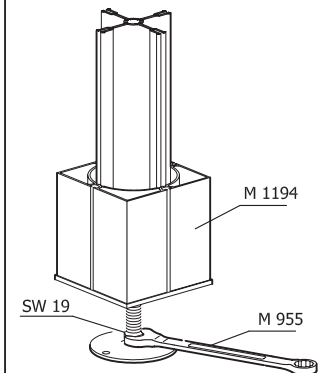

HEX-STAR DRIVER T25

plastic/steel
hex-star T25 for M 1611/20
0.077 kg

M 1616

M 1616.90

OCTASHINE

1000 ml bottle cleaning and polishing
emulsion for anodized aluminium
1.136 kg

E 120

E 120.90

OCTASHINE

100 ml bottle cleaning and polishing
emulsion for anodized aluminium
0.121 kg

E 120/P

E 120/P.90

TOOLS

CLEANER

500 ml bottle for powder-coated surfaces
and plastic extrusions
1.067 kg



E 124

E 124.90



DRILLING JIGS
AND DRILLS

DRILLING JIG

steel/aluminium
body with drill guide bush ZBS 100 (8 mm)
and distance block ZBS 140
for 8 mm system drilling for fitting tension
locks Z 961/8 in upright extrusions
drilling tools must be ordered separately
0.612 kg



BS 4

DRILLING JIGS
AND DRILLS

BS 4.90

ACCESSORIES-SET FOR BS 4

aluminium/steel
for 8 mm system drilling,
for fitting tension locks Z 961/8 in
extrusions M 1025, M 1091, M 1018
0.1 kg



BS 4 ZS 1

BS 4 ZS 1.90

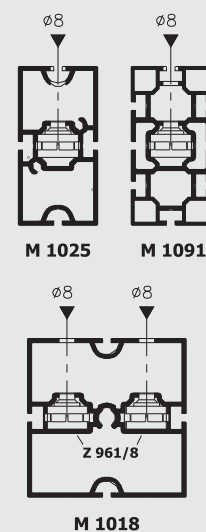

ACCESSORIES-SET FOR BS 4

aluminum/steel
for 8 mm system drilling,
for fitting tension locks Z 961/8 in
extrusion series S 800 ... S 815
0.2 kg



BS 4 ZS 2

BS 4 ZS 2.90

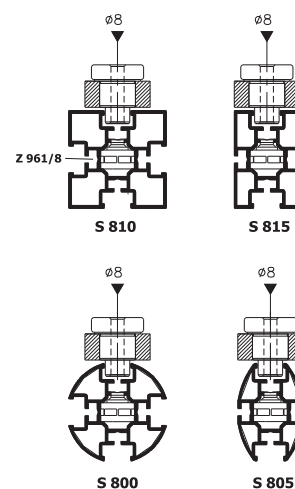

TOOLS, TRANSPORT

DRILLING JIGS AND DRILLS

DRILLING JIG

steel/aluminium body with drill guide bush ZBS 101 (9 mm) and distance block ZBS 140 for 9 mm system drilling and countersinking for fitting tension locks Z 962/T or straight connector Z 967
drilling tools must be ordered separately
0.609 kg



BS 5

DRILLING JIGS AND DRILLS

BS 5.90

DRILLING JIG

steel/aluminium body with drill guide bush ZBS 102 (13 mm) and 4 spacer pins ZBS 141 for extrusions Z 100, Z 110 for 13 mm system drilling for fitting tension locks Z 961/13
drilling tools must be ordered separately
0.435 kg



BS 6

BS 6.90

SUPPLEMENTARY SET FOR BS 6

consisting of interchangeable drill guide bush ZBS 103, drill ZBS 151, beam piece 15.3 mm for fitting in tension lock Z 960
0.155 kg



ZBS 145

ZBS 145.90

DRILLING JIG

steel/aluminium body with drill guide bush ZBS 101 (9 mm) and distance block ZBS 140, clamping screw and adjustable pin for miter end and 4 spacer pins ZBS 141 accessories: beam distance pieces for Z 953L/R and Z 964 for 9 mm system drilling and countersinking extrusions with mitered ends 7.5 to 45° for fitting internal connectors and tension locks Z 963L/R and Z 953L/R
drilling tools must be ordered separately
0.865 kg

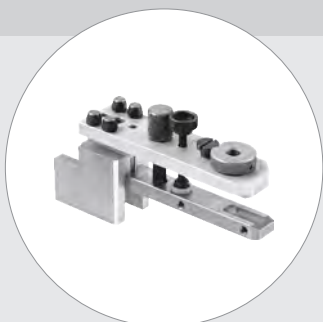

BS 8

BS 8.90

TOOLS, TRANSPORT

DRILLING JIGS AND DRILLS

DRILLING JIG

aluminium body
with locating pins and fixed built-in drill guide bushes 3.2 and 4.5 mm
4,5 mm system drilling for fitting knuckle joints in extrusion M 1600 and 3,2 mm for fitting M 1610 in extrusions M 1602, M 1603
drilling tools must be ordered separately
0.39 kg

BS 9

BS 9.90

DRILLING JIG

steel/aluminium body
with 2 fixed built-in 6.4 mm drill guide bushes
for 6.4 mm system drilling and countersinking
for fitting knuckle joints in extrusions V 2100
drilling tools must be ordered separately
0.485 kg

BS 13

BS 13.90

DRILLING JIG

steel body
with hardened 8.9 mm drilling
for 8.9 mm system drilling
for fitting the glass door hinge (V 2225) in beam and upright extrusions
drilling tools must be ordered separately
0.155 kg

BS 14

BS 14.90

DRILLING JIG

aluminium body
with 2 fixed built-in drill guide bushes 6.2 mm
for 6.2 mm system drilling
for fitting the safety stop M 826 in beam and upright extrusions
drilling tools must be ordered separately
0.119 kg

BS 30

BS 30.90

DRILLING JIG

aluminium body
with fixed built-in drill guide bushes and clamping lever
accessories:
drilling tools ZBS 112, ZBS 115, ZBS 151
for 12/10/8 mm system drillings
for fitting adaptor with tension lock M 1102, M 1104 and adaptor for hinged end plates M 1282 in 120 mm square extrusions
0.948 kg

BS 31

BS 31.90

TOOLS, TRANSPORT

DRILLING JIGS AND DRILLS

DRILLING JIG

plastic body with fixed built-in drill guide bushes and clamping lever
 accessories:
 drilling tools ZBS 115, ZBS 150 for 12/8.5 mm system drillings for fitting adaptor with tension lock M 1102, M 1104 and adaptor for hinged end plates M 1282 in 120 mm round extrusions
 0.338 kg



BS 32

DRILLING JIGS AND DRILLS

BS 32.90

DRILLING JIG

plastic body with fixed built-in drill guide bushes and clamping lever
 accessories:
 drilling tools ZBS 112, ZBS 153 for 10/8 system drillings for fitting the adaptors with tension lock M 1101, M 1291 and adaptor for hinged end plates M 1281 in 80 mm square extrusions and round extrusions
 0.132 kg



BS 33

BS 33.90

DRILLING JIG

plastic body with fixed built-in drill guide bushes and clamping lever
 accessories:
 drilling tools ZBS 112, ZBS 153 for 10/8 mm system drillings for fitting adaptor with tension lock M 1100 and adaptor for hinged end plates M 1555 in 60 mm square extrusions and round extrusions
 0.151 kg



BS 34

BS 34.90

DRILLING JIG

aluminium body with fixed built-in drill guide bushes and clamping lever
 accessories:
 drilling tools ZBS 112, ZBS 153 for 10/8 mm system drillings for fitting the adaptor with tension lock M 1101, M 1114, M 1116 and base plate M 1406 in square extrusions M 1020, M 1021 (80 mm)
 0.565 kg



BS 35

BS 35.90

TOOLS, TRANSPORT

DRILLING JIGS
AND DRILLS

DRILLING JIG

aluminium body
with fixed built-in drill guide bushes and
clamping lever
accessories:
drilling tools ZBS 112, ZBS 153
for 10/8 mm system drillings
for fitting adaptor with tension lock M 1103
in square extrusions M 1020,
M 1021 (80 mm)
0.564 kg



BS 36

BS 36.90

DRILL GUIDE
BUSH 8 MM DIA.

steel, hardened
8 mm dia.
interchangeable, for use with BS 4
0.096 kg



ZBS 100

DRILL GUIDE
BUSHES

ZBS 100.90

DRILL GUIDE
BUSH 13 MM DIA.

steel, hardened
13 mm dia.
interchangeable, for use with BS 6
0.078 kg



ZBS 102

ZBS 102.90

DRILL GUIDE
BUSH 10 MM DIA.

steel, hardened
10 mm dia.
accessorie in supplementary set ZBS 145
interchangeable, for use with BS 6
0.089 kg



ZBS 103

ZBS 103.90

DRILL GUIDE
BUSH 12 MM DIA

steel, hardened
Ø 12 mm dia.
used in conjunction with step drill ZBS 115
interchangeable, for use with **BS 8**
0.009 kg



ZBS 104

ZBS 104.90

TOOLS, TRANSPORT

DRILLING JIGS
AND DRILLS

TWIST DRILL 6.2 MM DIA.

special tool for drilling aluminium
6.2 mm dia.
for use with **BS 30**
0.015 kg

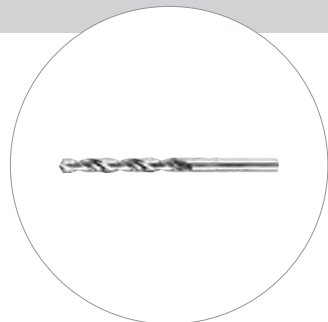

ZBS 152

TWIST DRILLS

ZBS 152.90

TWIST DRILL 6.4 MM DIA.

special tool for drilling aluminium
6,4 mm dia.
for use with **BS 13**
0.016 kg



ZBS 116

ZBS 116.90

TWIST DRILL 8 MM DIA.

special tool for drilling aluminium
8 mm dia.
for use with **BS 4, BS 12, BS 31, BS 33,**
BS 34
0.024 kg



ZBS 112

ZBS 112.90

TWIST DRILL 8.5 MM DIA.

special tool for for drilling aluminium
8.5 mm dia.
for use with **BS 32**
0.032 kg



ZBS 150

ZBS 150.90

TWIST DRILL 8.9 MM DIA.

special tool for drilling aluminium
8.9 mm dia.
for use with **BS 14**
0.031 kg



ZBS 117

ZBS 117.90

TOOLS, TRANSPORT

DRILLING JIGS
AND DRILLS

TWIST DRILL 9 MM DIA.

special tool for drilling aluminium
9 mm dia.
for use with **BS 5, BS 8**
0.035 kg



ZBS 113

ZBS 113.90

TWIST DRILL 10 MM DIA.

special tool for drilling aluminium
10 mm dia.
for use with **BS 31**
0.052 kg



ZBS 151

ZBS 151.90

TWIST DRILL 13 MM DIA.

special tool for drilling aluminium
13 mm dia.
for use with **BS 6**
0.072 kg



ZBS 114

ZBS 114.90

COUNTERSINK
9.7 MM DIA./90°

9.7 mm / 90°
for use with **BS 13**
0.011 kg



ZBS 122

COUNTERSINKS

ZBS 122.90

COUNTERSINK
12.4 MM DIA./90°

12.4 mm dia.
for use with **BS 5, BS 8,**
0.03 kg



ZBS 120

ZBS 120.90

TOOLS, TRANSPORT

DRILLING JIGS
AND DRILLS

COUNTERSINK
16.5 MM DIA./90°

16.5 mm dia./ 90°
for universal use
0.041 kg



ZBS 121

COUNTERSINKS

ZBS 121.90

STEP DRILL 10/
5.3 MM DIA./90°

special tool for drilling aluminium
with adjustable depth stop ring
10/5.3 mm dia./ 90°
for use with BS 33, BS 34
0.057 kg



ZBS 153

STEP DRILL

ZBS 153.90

STEP DRILL 12/
6.5 MM DIA./90°

special tool for drilling aluminium
with adjustable depth stop ring
12/6.5 mm dia. / 90°
for use with BS 3, BS 31, BS 32
0.113 kg



ZBS 115

ZBS 115.90

STEP DRILL 12/
6.5 MM DIA./90°

special tool for drilling aluminium
12/6.5 mm dia. / 90°
for use with BS 3, BS 31, BS 32
0.079 kg



ZBS 115B

ZBS 115B.90

DEPTH STOP RING

steel, with locking screw
for step drill bit ZBS 115B
0.033 kg



ZBS 115A

ZBS 115A.90

TOOLS, TRANSPORT

DRILLING JIGS
AND DRILLS

MACHINE HANDTAP DRILL M8

with guide pilot
M8
for extrusions V 2000, V 2020
0.037 kg



ZBS 131

HANDTAP DRILL

ZBS 131.90

MACHINE HANDTAP DRILL M10

for long female threads in upright
extrusions
M10
140 mm long
0.059 kg



ZBS 130

ZBS 130.90

TOOLS, TRANSPORT

TRANSPORT CASES

CASE FOR UPRIGHT EXTRUSIONS

sheet steel
with handles and snap closures, foam
liners to protect the ends and plastic
extrusions
for 20 S 110/S 118
or 10 S 408, 2500 mm long
or 25 S 208, 2500 mm long
or 25 S 308, 2500 mm long
or 20 S 500, 2500 mm long
2575/238/200 mm (l/w/h)
21.87 kg



K 900

TRANSPORT CASES

K 900.37

CASE FOR BEAMS 37 MM

sheet steel
with handles and snap closures, foam
liners to protect the ends and plastic
extrusions
for 70 Z 320
720/238/320 mm (l/w/h)
9.278 kg



K 921

FOR BEAM 37 MM

K 921.37

CASE FOR BEAMS 37 MM

sheet steel
with handles and snap closures, foam
liners to protect the ends and plastic
extrusions
for 70 Z 330
1420/238/320 mm (l/w/h)
16.25 kg



K 923

K 923.37

CASE FOR CURVED BEAMS 37 MM

sheet steel
with handles and snap closures
foamed inserts matching extrusion cross
sections, foam liners to protect the ends
for 50 Z 351
1020/450/235 mm (l/w/h)
14.95 kg



K 926

FOR CURVED BEAMS 37 MM

K 926.37

TOOLS, TRANSPORT

TRANSPORT CASES

CASE FOR BEAMS 50 MM

sheet steel
with handles and snap closures, foam
liners to protect the ends and plastic
extrusions
for 120 Z 415/Z 416
1010/238/370 mm (l/w/h)
13.127 kg

K 930

FOR BEAMS 50 MM

K 930.37

CASE FOR BEAMS 50 MM

sheet steel
with handles and snap closures, foam
liners to protect the ends and plastic
extrusions
for 60 Z 420/Z 421
720/238/370 mm (l/w/h)
9.994 kg

K 931

K 931.37

CASE FOR BEAMS 50 MM

sheet steel
with handles and snap closures, foam
liners to protect the ends and plastic
extrusions
for 60 Z 425/Z 426
1010/238/370 mm (l/w/h)
13.127 kg

K 932

K 932.37

CASE FOR BEAMS 50 MM

sheet steel
with handles and snap closures, foam
liners to protect the ends and plastic
extrusions
for 60 Z 430/Z 431
1420/238/370 mm (l/w/h)
17.477 kg

K 933

K 933.37

CASE FOR CURVED
BEAMS 50 MM

sheet steel
with handles and snap closures
foamed inserts matching extrusion cross
sections, foam liners to protect the ends
for 40 Z 452/Z 442
1400/560/235 mm (l/w/h)
22.023 kg

K 937

FOR CURVED
BEAMS 50 MM

K 937.37

TOOLS, TRANSPORT

TRANSPORT CASES

CASE FOR BEAMS 70 MM

sheet steel
with handles and snap closures, foam
liners to protect the ends and plastic
extrusions
for 80 Z 115/Z 116
1010/238/320 mm (l/w/h)
12.188 kg

K 910

FOR BEAMS 70 MM

K 910.37

CASE FOR BEAMS 70 MM

sheet steel
with handles and snap closures, foam
liners to protect the ends and plastic
extrusions
for 40 Z 120/Z 121
720/238/320 mm (l/w/h)
9.278 kg

K 911

K 911.37

CASE FOR BEAMS 70 MM

sheet steel
with handles and snap closures, foam
liners to protect the ends and plastic
extrusion
for 40 Z 125/Z 126
1010/238/320 mm (l/w/h)
12.188 kg

K 912

K 912.37

CASE FOR BEAMS 70 MM

sheet steel
with handles and snap closures, foam
liners to protect the ends and plastic
extrusion
for 40 Z 130/Z 131
1420/238/320 mm (l/w/h)
16.25 kg

K 913

K 913.37

CASE FOR CURVED
BEAMS 70 MM

sheet steel
with handles and snap closures
foamed inserts matching extrusion cross
sections, foam liners to protect the ends
for 30 Z 151/Z 141
1020/450/235 mm (l/w/h)
14.336 kg

K 916

FOR CURVED
BEAMS 70 MM

K 916.37

TOOLS, TRANSPORT

TRANSPORT CASES

CASE FOR BEAMS 175 MM

sheet steel
with handles and snap closures, foam
liners to protect the ends and plastic
extrusions
for 40 Z 514/Z 516
1010/238/370 mm (l/w/h)
13.127 kg

K 940

FOR BEAMS
175 MM

K 940.37

CASE FOR BEAMS 175 MM

sheet steel
with handles and snap closures, foam
liners to protect the ends and plastic
extrusions
for 20 Z 519/Z 521
720/238/370 mm (l/w/h)
9.994 kg

K 941

K 941.37

CASE FOR BEAMS 175 MM

sheet steel
with handles and snap closures, foam
liners to protect the ends and plastic
extrusions
for 20 Z 524/Z 526
1010/238/370 mm (l/w/h)
13.127 kg

K 942

K 942.37

CASE FOR BEAMS 175 MM

sheet steel
with handles and snap closures, foam
liners to protect the ends and plastic
extrusions
for 20 Z 529/Z 531
1420/238/370 mm (l/w/h)
17.477 kg

K 943

K 943.37

CASE FOR BEAMS 175 MM

sheet steel
with handles and snap closures, foam
liners to protect the ends and plastic
extrusions
for 20 Z 625
1010/238/370 mm (l/w/h)
13.127 kg

K 952

K 952.37

TOOLS, TRANSPORT

TRANSPORT CASES

CASE FOR CURVED BEAMS 175 MM

sheet steel
with handles and snap closures
foamed inserts matching extrusion cross sections, foam liners to protect the ends
for 20 Z 591/Z 541
1020/450/370 mm (l/w/h)
18.016 kg



K 946

FOR CURVED BEAMS 175 MM

K 946.37

CASE FOR CURVED BEAMS 175 MM

sheet steel
with handles and snap closures
foamed inserts matching extrusion cross sections, foam liners to protect the ends
for 20 Z 592/Z 542
1400/560/370 mm (l/w/h)
26.82 kg



K 947

K 947.37

CASE FOR CEILING ELEMENTS

without inner partition
1010/1010/340 mm (l/w/h)
30.446 kg



K 990

UNIVERSAL BOX

K 990.37

EXTRUSION FOR INNER PARTITION

plastic
5000 mm long
1.415 kg



K 980

INNER PARTITIONS

K 980.33

TRANSPORT CASES

END DIVIDERS FOR CASES

plastic
inner partition with polystyrene parts for
sheet steel cases,
185 mm high
for K 900
0.06 kg



K 981

K 981.33

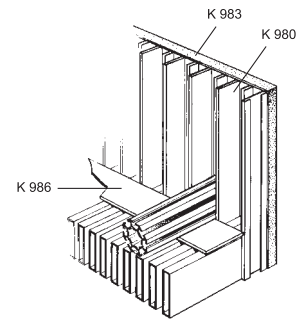

END DIVIDERS FOR CASES

plastic
inner partition with polystyrene parts for
sheet steel cases,
305 mm high
for K 910 - K 913, K 920 - K 923
0.5 kg



K 982

K 982.33

END DIVIDERS FOR CASES

plastic
inner partition with polystyrene parts for
sheet steel cases,
355 mm high
for K 930 - K 933, K 940 - K 943,
K 950 - K 953
0.11 kg



K 983

K 983.33

CENTER DIVIDERS FOR CASES

plastic
inner partition with polystyrene parts for
sheet steel cases,
305 mm high
for K 910, K 920
1 kg

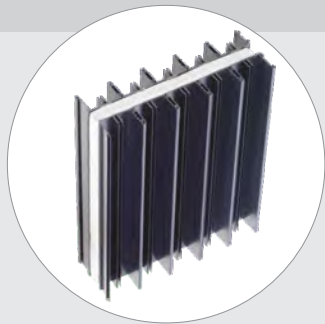

K 984

K 984.33

TOOLS, TRANSPORT

TRANSPORT CASES

CENTER DIVIDERS FOR CASES

plastic
inner partition with polystyrene parts for
sheetsteel cases,
355 mm high
for K 930, K 940, K 950
1.2 kg

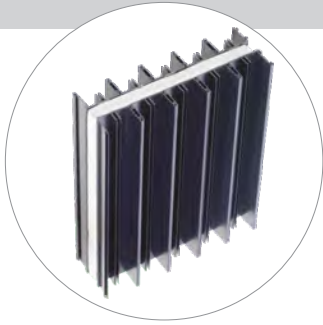

K 985

INNER
PARTITIONS

K 985.33

INTERMEDIATE LAYER

plastic
flat extrusion 35 x 3 mm
238 mm long
0.034 kg



K 986

K 986.33

BEAM PACKING EXTRUSION

aluminium,
with 10 slots for tension lock Z 961/13
for Z 160, Z 310, Z 400, Z 500, Z 508, Z 560,
Z 600, ...
0.066 kg



K 970

TRANSPORT
PROTECTION

K 970.00

BEAM PACKING EXTRUSION

aluminium,
with 10 slots for tension lock Z 961/13 with
Z 161/A
for Z 100 and Z 110
0.096 kg



K 971

K 971.00

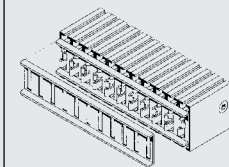

PACKING STRIP

plastic
for **5 square extrusions 80 mm**
"Protection in transit!"
0.122 kg



M 980

M 980.33

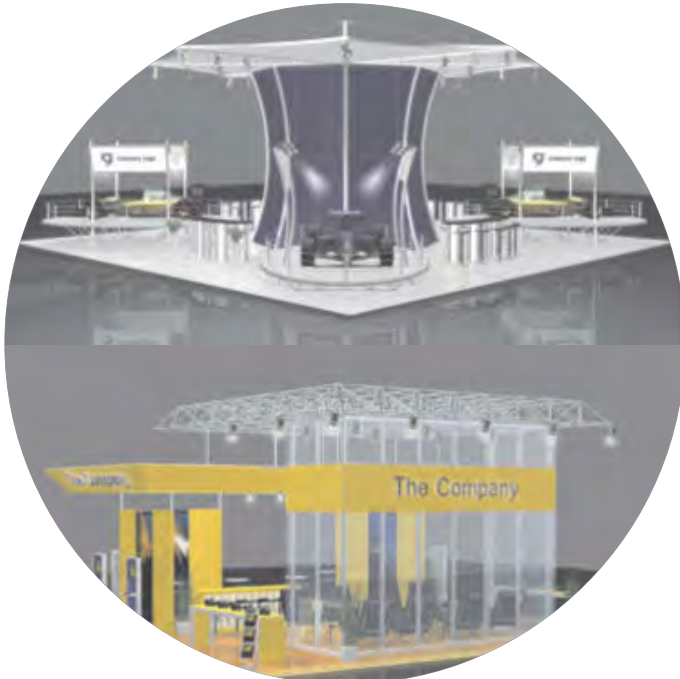

OCTAdesign
364

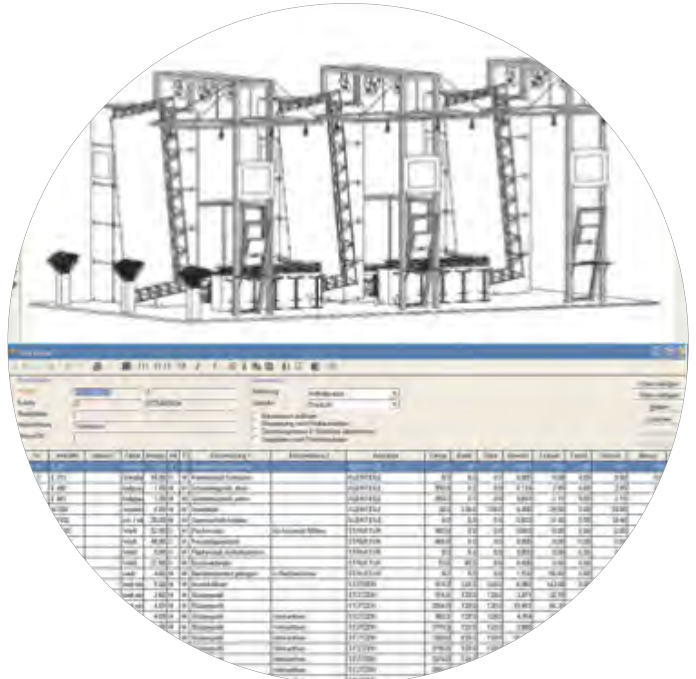

OCTAcad
365

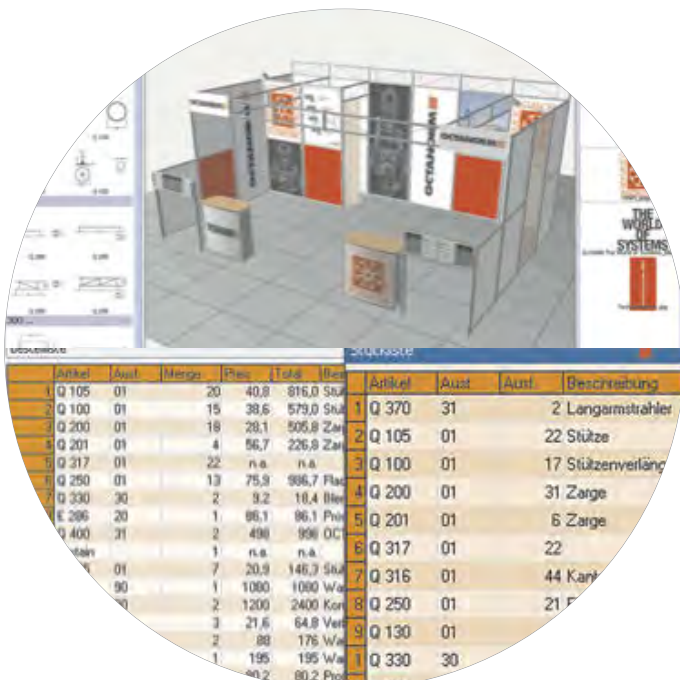

OCTAsnap
366



Design Center
367



Software Training
368

OCTADESIGN

OCTADESIGN

**THE ESSENTIAL PROFESSIONAL
SOFTWARE FOR DESIGNERS.**

OCTAdesign sets new standards in streamlining and accelerating your workflow. Created in simple to use modules and as a construction system-independent software , OCTAdesign accommodates the creativity of designers and allows architectural freedom.

The interactive mode of operation of the program and useful scaling facilities make it possible to quickly produce rendered versions of drawings. It offers a variety of construction possibilities and presentation features that include slides, panorama pictures and virtual reality.

Complete with external and internal views and any camera movements you want, this software also accounts for budget control and parts list.

OCTAdesign quickly and efficiently generates professional presentations!

Please visit www.octadesign.com for complete details and prices.

1-ODESIGN

1-ODESIGN.90

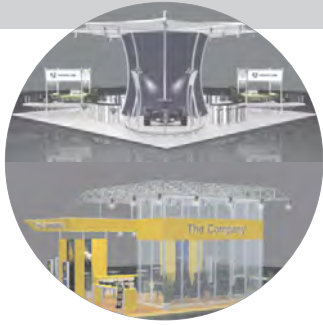

OCTACAD

OCTACAD

FOR SUCCESSFUL STAND CONSTRUCTION DRAWINGS

CAD technology has become an irreplaceable tool for exhibition design for planning, constructing, optimizing, and analyzing.

The software facilitates the construction of temporary and permanent projects without complications. Each step of the process is documented, logged and recorded, and all extra costs and requirements are anticipated and accounted for.

The integrated management tool of OCTAcad can even manage the parts lists, weights, and the availability of the parts in stock with ease.

OCTAcad provides the flexibility to work more productively from concept to completion.

Please visit www.octacad.com for complete details and prices.



1-OCAD

1-OCAD.90

OCTASNAP

OCTASNAP

1-OCTASNAP

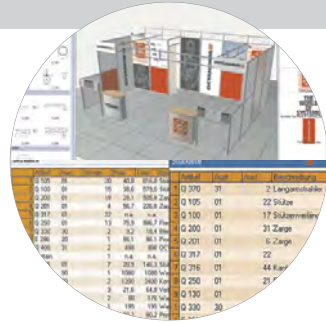

THE VISUAL SALES TOOL FOR OCTAQUICK AND VARIO DISPLAYS.

OCTAsnap allows you to effortlessly present OCTAquick and vario displays. This software allows you to Drag'n Drop single components into the drawing area, add customer's logo or graphics (scanned or copied from the web).

OCTAsnap calculates parts and costs as you work and presents a visual presentation all within a few minutes. This software can be handled easily and intuitively even by untrained users.

Create and present OCTAquick and vario displays efficiently and professionally with OCTAsnap.

Please visit www.octasnap.com for complete details and prices.

1-OCTASNAP.LT

DESIGN CENTER

DESIGNCENTER

1-DCENTER

BENEFIT FROM OUR MANPOWER.

We offer you the the following services.

- Visualization of your booths
- Visualization of your interior designs
- Visualization of your displays

Price on request

1-DCENTER.90



**SOFTWARE
AND SERVICE**

SOFTWARE TRAINING

TRAINING

Knowledge is the keystone for a successful business. Please contact us for training - we are your partner for success.



1-SCHULUNG

1-SCHULUNG.90

INDEX

INDEX ARTICLE NUMBER

ARTICLE	PAGE	DESCRIPTION
1-DCENTER	367	DESIGNCENTER
1-OCAD	365	OCTAcad
1-OCTASNAP	366	OCTASNAP
1-ODESIGN	364	OCTADesign
1-SCHULUNG	368	TRAINING
A 200	252	Edge protection
A 220	252	Knuckle joint
A 230	252	Knuckle joint
BS 4	345	Drilling jig
BS 4 ZS 1	345	Accessories-Set for BS 4
BS 4 ZS 2	345	Accessories-Set for BS 4
BS 5	346	Drilling jig
BS 6	346	Drilling jig
BS 8	346	Drilling jig
BS 9	347	Drilling jig
BS 13	347	Drilling jig
BS 14	347	Drilling jig
BS 30	347	Drilling jig
BS 31	347	Drilling jig
BS 32	348	Drilling jig
BS 33	348	Drilling jig
BS 34	348	Drilling jig
BS 35	348	Drilling jig
BS 36	349	Drilling jig
C 441	17	Adjustable foot, 135° corner
D 155	139	Perforated ceiling grid
D 171	317	Double fluorescent light
D 208/N	317	Electric distribution box
D 216	317	Electric distribution box
D 1145	317	Low voltage spotlight
E 13	339	Hex-star driver
E 14	339	Hex-star driver T30
E 113	339	Hex-star driver T30
E 114	339	Hex-star wrench
E 115	339	Ratchet 1/4"
E 116	340	Hex-star head attachment 1/4", T30
E 116/42	340	Hex-star head attachment 1/4", T30
E 117	340	Hexagon wrench set
E 119	340	Open ended spanner
E 120	343	OCTASHINE
E 120/P	343	OCTASHINE
E 124	344	Cleaner
E 130	340	Screwdriver set
E 131	341	Hexagon screwdriver
E 132	341	Hexagon screwdriver
E 185	318	Adaptor for monitor 15" - 21"
E 186	318	Adaptor for monitor 15" - 21"
E 188	319	Adaptor for monitor 20" - 32"
E 191	319	Monitor fixing set
E 195	319	Monitor fixing set
E 203	279	Hammerhead screw
E 205	279	Hammerhead screw
E 207	279	Hammerhead screw
E 209	279	Hammerhead screw
E 210	279	Hammerhead screw
E 210/M8	280	Hammerhead screw
E 211	280	Supporting angle
E 212	293	Reinforcing plate
E 213	293	Reinforcing plate
E 217	280	Sleeve

INDEX

INDEX ARTICLE NUMBER

ARTICLE	PAGE	DESCRIPTION
----------------	-------------	--------------------

E 218	300	Screw eye
E 219	300	Screw hook
E 220	240	Fascia hook
E 220/S	240	Fascia hook
E 221	288	Panel retainer
E 225	139	Ceiling panel retainer
E 226	139	Ceiling panel retainer
E 240	300	Drapery glider
E 245	250	Cable clamp
E 250	301	Adjustable foot
E 261	264	Sliding plane clamp
E 262	264	Connecting clamp
E 263	265	Connecting clamp
E 265	278	Hammerhead screw
E 271	239	Graphic panel retainer
E 272	240	Insert piece
E 273	240	Graphic panel retainer
E 275	300	Bag holder
E 277	321	Literature dispenser
E 280	314	Coat hanger beam
E 281	314	Coat hook
E 282	263	Internal corner connector 135°
E 283	263	Internal corner connector 135°
E 284	314	Coat hook
E 286	321	Literature rack
E 290	268	Hinge plate
E 290/D	268	Hinge plate
E 291	272	Hinged bolt lock
E 292	272	Hinged bolt lock
E 292/A	272	Suspension plate
E 295/N	274	Sliding door lock
E 296/L	269	Hinge plate
E 296/R	269	Hinge plate
E 297	268	Glass door hinge
E 297/M	268	Glass door hinge
E 300	270	Hinge plate
E 305	271	Hinge
E 306	270	Hinge plate
E 307/L	270	Hinge plate left
E 307/R	271	Hinge plate right
E 310	271	Hinge pin
E 315	288	Shelf extrusion
E 318	288	End cap
E 400	273	Upper track for sliding doors
E 401	273	Lower track for sliding doors
E 410	273	Door handle extrusion
E 410/AI	273	Door handle extrusion
E 420	243	Glass panel retainer
E 421	244	Glass panel retainer
E 422	244	Glass panel retainer
E 424	243	Glass panel retainer
E 428	243	Panel retainer extrusion
E 430	244	Door stopping extrusion
E 433	245	Door stopping extrusion
E 438	253	Extrusion connector
E 440	245	Glass frame extrusion
E 441	245	Rubber sponge bumper
E 442	242	Supporting edge
E 443	243	Glass retainer
E 444	246	Anti-rattle strip

INDEX

INDEX ARTICLE NUMBER

ARTICLE	PAGE	DESCRIPTION
E 445	246	Anti-rattle strip
E 450	253	Extrusion connector
E 451	253	Extrusion connector
E 452	253	Extrusion connector
E 455	247	Groove filler
E 458	247	Cover extrusion
E 460	250	Cable retaining extrusion
E 463	251	Cable retaining extrusion
E 470/C	274	Clip
E 470/E	292	Threaded plate
E 470/N	274	Sliding door extrusion
E 471/N	274	Runner
E 472	275	Runner frame extrusion
E 473	275	Roller
E 473/H	275	Roller
E 474	275	End piece
E 475/N	275	Anti-rattle extrusion
E 476	276	Clamping extrusion
E 477	276	Clamping extrusion
E 478	276	Sliding door lock
E 479	276	Replacement key
E 480	276	Flat rubber
E 481	277	Glide handle
E 484	277	Locking end piece
E 485	277	Locking plate
E 702	283	Interior corner connector
E 708	284	Shelf bracket
E 708/K	284	End cap
E 710	284	Shelf bracket 150 mm
E 710/K	284	End cap
E 711	284	Shelf bracket 200 mm
E 712	285	Shelf bracket 250 mm
E 713	285	Shelf bracket 300 mm
E 718	283	Bracket for wooden shelves
E 719	282	Bracket for glass shelf
E 720/G	285	Shelf bracket connector
E 723	285	Shelf bracket
E 725	286	Slide-in shelf bracket
E 726	286	Slide-in shelf bracket 20°
E 727	287	Slide-in shelf bracket 30°
E 728	283	Bracket for wooden shelves
E 733	286	Shelf bracket
E 735	287	Brackets / Straight 300 mm
E 737	287	Shelf bracket 30°
E 739	287	Shelf board
E 743	286	Shelf bracket
E 800	313	Clothes rod extrusion
E 804	313	Clothes rod bracket
E 810	313	Clothes rod
E 811	313	Clothes rod
E 815	313	Coat hanger beam
K 900	354	Case for upright extrusions
K 910	356	Case for beams 70 mm
K 911	356	Case for beams 70 mm
K 912	356	Case for beams 70 mm
K 913	356	Case for beams 70 mm
K 916	356	Case for curved beams 70 mm
K 921	354	Case for beams 37 mm
K 923	354	Case for beams 37 mm
K 926	354	Case for curved beams 37 mm

INDEX

INDEX ARTICLE NUMBER

ARTICLE

PAGE

DESCRIPTION

K 930	355	Case for beams 50 mm
K 931	355	Case for beams 50 mm
K 932	355	Case for beams 50 mm
K 933	355	Case for beams 50 mm
K 937	355	Case for curved beams 50 mm
K 940	357	Case for beams 175 mm
K 941	357	Case for beams 175 mm
K 942	357	Case for beams 175 mm
K 943	357	Case for beams 175 mm
K 946	358	Case for curved beams 175 mm
K 947	358	Case for curved beams 175 mm
K 952	357	Case for beams 175 mm
K 970	360	Beam packing extrusion
K 971	360	Beam packing extrusion
K 980	358	Extrusion for inner partition
K 981	359	End dividers for cases
K 982	359	End dividers for cases
K 983	359	End dividers for cases
K 984	359	Center dividers for cases
K 985	360	Center dividers for cases
K 986	360	Intermediate layer
K 990	358	Case for ceiling elements
M 110	68	Connector head
M 125	68	Adaptor set
M 130	68	Connector head
M 205	37	Round extrusion 120 mm
M 206	37	Round extrusion 120 mm
M 207	38	Round extrusion 120 mm
M 215	38	Round extrusion "open" 120 mm
M 216	38	Round extrusion "open" 120 mm
M 217	39	Round extrusion "open" 120 mm
M 220	39	Cover extrusion, translucent
M 225	27	Square extrusion 120 mm
M 226	27	Square extrusion 120 mm
M 227	28	Square extrusion 120 mm
M 230	29	Square extrusion 120 mm
M 232	30	Square extrusion 120 mm
M 235	36	Round extrusion 120 mm
M 236	36	Round extrusion 120 mm
M 237	36	Round extrusion 120 mm
M 245	37	Round extrusion 120 mm - 60°
M 270	39	End plate
M 274	31	End plate
M 282	40	Adjustable foot
M 285	31	Adjustable foot
M 300	69	Upright
M 440	69	Triangular truss beam
M 441	69	Triangular truss beam
M 450	70	Triangular truss beam
M 451	70	Triangular truss beam
M 500	70	Flange for truss beam
M 510	71	Flange for truss beam
M 520	71	Corner connector 90° "horizontal"
M 531	71	Adjustable connection flange
M 535	72	Stabilizing diagonal tube
M 536	72	Fixing angle
M 550	72	Screw Set
M 555	72	Suspension connector
M 556	73	Suspension connector
M 640	74	Flat truss beam

INDEX

INDEX ARTICLE NUMBER

ARTICLE	PAGE	DESCRIPTION
M 641	74	Flat truss beam
M 650	74	Flat truss beam
M 651	75	Flat truss beam
M 655	75	Suspension connector
M 661	75	Connection flange
M 703	76	Flat truss beam
M 704	76	Flat truss beam
M 705	77	Flat truss beam
M 706	77	Flat truss beam
M 727	78	Tie rod tensioning set / 7 axes
M 728	78	Tie rod tensioning set / 8 axes
M 730	79	Tie rod tensioning set / 10 axes
M 732	79	Tie rod tensioning set / 12 axes
M 734	80	Tie rod tensioning set / 14 axes
M 737	81	Truss girder / 7 axes
M 738	81	Truss girder / 8 axes
M 740	82	Truss girder / 10 axes
M 742	82	Truss girder / 12 axes
M 744	83	Truss girder / 14 axes
M 746	83	Truss girder / 6 axes
M 747	84	Truss girder / 7 axes
M 748	84	Truss girder / 8 axes
M 750	85	Truss girder / 10 axes
M 755	77	Flat truss beam adaptor
M 756	85	Truss girder / 6 axes
M 757	86	Truss girder / 7 axes
M 758	86	Truss girder / 8 axes
M 760	87	Truss girder / 10 axes
M 770	76	Beam extrusion
M 776	87	Truss girder / 6 axes
M 777	88	Truss girder / 7 axes
M 778	88	Truss girder / 8 axes
M 780	88	Truss girder / 10 axes
M 785	89	Truss girder / 5 axes
M 786	89	Truss girder / 6 axes
M 787	89	Truss girder / 7 axes
M 811	163	Roller blind beam
M 812	278	Hammerhead screw
M 816	163	Roller blind beam
M 824	309	Base plate 455 mm dia.
M 825	309	Base plate 455 mm dia.
M 826	310	Safety stop
M 827	77	Hinged clamp
M 900	341	Mounting tool set
M 940	341	Hex-star driver T30
M 945	342	Hex-star head attachment 1/4", T30
M 951	342	T-handle screwdriver
M 952	342	T-handle screwdriver
M 955	343	Double box ratcheting wrench
M 980	360	Packing strip
M 1000	14	Square extrusion 40 mm
M 1000-25 P1	184	Cut to length extrusion
M 1000-25 S1	184	Upright
M 1001	14	Square extrusion 40 mm
M 1002	14	Square extrusion 40 mm
M 1003	14	Square extrusion 40 mm
M 1005	14	Square extrusion 40 mm
M 1007	15	Square extrusion 40 mm
M 1009	17	Exterior corner extrusion 135°
M 1010	18	Square extrusion 60 mm

INDEX

INDEX ARTICLE NUMBER

ARTICLE	PAGE	DESCRIPTION
M 1011	18	Square extrusion 60 mm
M 1012	24	Square extrusion 80 mm
M 1013	24	Square extrusion 80 mm
M 1014	16	End cap
M 1015	16	End plate
M 1015	184	End plate
M 1016	17	Adjustable foot
M 1017	25	Square extrusion 84 mm
M 1018	20	Square extrusion 80 mm
M 1019	21	Square extrusion 80 mm
M 1020	19	Square extrusion 80 mm
M 1021	19	Square extrusion 80 mm
M 1022	25	Square extrusion "open" 80 mm
M 1023	25	Square extrusion "open" 80 mm
M 1025	42	Rectangular extrusion 80 x 40 mm
M 1026	43	Rectangular extrusion 80 x 40 mm
M 1030	44	Rectangular extrusion 120 x 40 mm
M 1031	45	Rectangular extrusion 120 x 40 mm
M 1034	23	End cap
M 1035	23	End plate
M 1037	24	Base plate for adjustable foot
M 1038	24	Adjustable foot
M 1040	30	Square extrusion "open" 120 mm
M 1041	30	Square extrusion "open" 120 mm
M 1044	248	Cover extrusion
M 1045	30	Cover extrusion
M 1046	31	Cover extrusion
M 1050	241	Fascia hook
M 1052	46	Rectangular extrusion 160 x 80 mm
M 1057	32	Base plate for adjustable foot
M 1058	21	Lightrack mounting extrusion 80 mm
M 1059	22	Lightrack mounting extrusion 80 mm
M 1060	46	Rectangular extrusion "open" 120 x 60 mm
M 1063	25	Connecting extrusion
M 1064	257	Internal connector straight
M 1065	18	End plate
M 1066	32	Adjustable foot
M 1067	18	Adjustable foot
M 1068	41	Rectangular extrusion 40 x 28 mm
M 1069	42	Rectangular extrusion 40 x 28 mm
M 1070	26	Exterior corner extrusion 135°
M 1073	16	Knuckle joint
M 1078	292	Threaded plate
M 1079	26	Connector part set
M 1082	42	Rectangular extrusion 60 x 40 mm
M 1085	44	End plate
M 1086	44	Adjustable foot
M 1087	45	End plate
M 1088	45	Adjustable foot
M 1089	26	Fixing set
M 1091	43	Rectangular extrusion 80 x 40 mm
M 1092	43	Rectangular extrusion 80 x 40 mm
M 1095	27	End plate 135°
M 1096	27	Adjustable foot 135°
M 1097	46	End plate
M 1098	47	Adjustable foot
M 1099	42	End plate
M 1100	51	Adaptor with tension lock
M 1101	51	Adaptor with Tension lock
M 1102	54	Adaptor with tension lock

INDEX

INDEX ARTICLE NUMBER

ARTICLE	PAGE	DESCRIPTION
M 1103	51	Adaptor with Tension lock
M 1104/L	55	Adaptor with tension lock
M 1104/R	55	Adaptor with tension lock
M 1105	54	Beam retainer
M 1106	54	Beam retainer
M 1107	295	Angle for fixing of wire rope
M 1108	52	Beam retainer
M 1110	31	Reinforcement extrusion
M 1111	264	Internal corner connector
M 1112	289	Angle reinforcement
M 1113	263	Internal corner connector
M 1114	53	Adaptor with safety tension lock
M 1115	263	Internal corner connector
M 1116	53	Adaptor with safety tension lock
M 1117	181	Fixing angle
M 1117	294	Fixing angle
M 1118	294	Bracket for wire rope
M 1121	257	Internal connector straight
M 1122	55	Adaptor with tension lock
M 1123	258	Internal connector straight
M 1124	56	Adaptor with safety tension lock
M 1125	56	Beam retainer
M 1126	56	Adaptor with safety tension lock
M 1129	90	Angle reinforcement
M 1129	289	Angle reinforcement
M 1131	259	Internal connector straight
M 1132	90	Connector part
M 1132	290	Connector part
M 1133	260	Internal connector straight
M 1134	93	Reinforcing plate
M 1137	91	Quicklink
M 1137	296	Quicklink
M 1138	297	Threaded insert M6
M 1139	92	Angle reinforcement
M 1139	290	Angle reinforcement
M 1140	296	Round tube
M 1141	91	Anti-slipping device
M 1142	297	Hammerhead bolt
M 1144	298	Coupling pin
M 1145	297	Hammerhead bolt
M 1146	254	Distance piece
M 1147	298	Fixing-set
M 1148	299	Wall mounting plate
M 1149	298	End cap
M 1150	90	Angle reinforcement
M 1150	289	Angle reinforcement
M 1151	22	Adaptor with Tension lock
M 1155	22	Cover extrusion
M 1160	294	Fixing angle
M 1161/L	57	Safety tension lock, left
M 1161/R	57	Safety tension lock, right
M 1164	93	Reinforcing plate
M 1172	90	Connector part
M 1180	19	Connector "Top" 80 mm
M 1181	22	Internal connector straight
M 1182	20	Connector "Centre" 80 mm
M 1183	23	Internal connector straight
M 1184	20	Connector "Bottom" 80 mm
M 1190	28	Connector "Top" 120 mm
M 1192	29	Connector "Centre" 120 mm

INDEX

INDEX ARTICLE NUMBER

ARTICLE	PAGE	DESCRIPTION
M 1194	29	Connector "Bottom" 120 mm
M 1201	33	Round extrusion 40 mm
M 1202	33	Round extrusion 40 mm
M 1204	33	Round extrusion 40 mm
M 1205	257	Extrusion connector
M 1210	34	Round extrusion 60 mm
M 1215	33	End plate
M 1216	34	Adjustable foot
M 1220	35	Round extrusion 80 mm
M 1222	35	Round extrusion 80 mm
M 1225	48	Elliptical extrusion 80 x 40 mm
M 1227	49	Elliptical extrusion 120 x 40 mm
M 1230	257	Extrusion connector
M 1231	34	End plate
M 1232	34	Adjustable foot
M 1234	35	Adjustable foot
M 1235	35	End plate
M 1237	36	Base plate for adjustable foot
M 1238	309	Base plate 455 mm dia.
M 1239	308	Base plate 400 mm dia.
M 1240	308	Base plate 335 mm dia.
M 1242	308	Base plate 335 mm dia.
M 1245	48	End plate
M 1246	48	Adjustable foot
M 1250	63	Hinged end plate
M 1255	64	Hinged end plate
M 1258	64	Hinged end plate
M 1260	63	Hinged end plate
M 1262	91	Tension brace junction knot
M 1264	91	Tension brace junction knot
M 1265	63	Hinged end plate
M 1270	64	Hinged flange plate
M 1271	65	Hinged flange plate
M 1276	65	Screw set
M 1277	65	Wing nut set
M 1278	65	Cover cylinder set
M 1279	66	Hinged plate with eyelet
M 1280	62	Steel wire with turnbuckle
M 1280	66	Steel wire with turnbuckle
M 1281	63	Adaptor for hinged end plate
M 1282	64	Adaptor for hinged end plate
M 1285	52	Adaptor
M 1286	53	Adaptor
M 1290	295	Connector part
M 1291	52	Adaptor with tension lock
M 1292	290	Connector part
M 1295	62	Hinged end plate
M 1296	62	Hinged end plate
M 1299	66	Anti-slipping device
M 1302	153	Fabric tension extrusion
M 1304	147	Fabric tension extrusion
M 1305	146	Fabric tension extrusion 40 mm
M 1307	147	Fabric tension extrusion
M 1309	152	Fabric tension extrusion
M 1310	142	Fabric tension extrusion 40 mm
M 1311	143	Connection extrusion
M 1312	154	U-channel extrusion
M 1313	159	Silicone edge
M 1314	155	Connecting plate
M 1319	146	Fabric tension extrusion

INDEX

INDEX ARTICLE NUMBER

ARTICLE	PAGE	DESCRIPTION
M 1320	41	Beam extrusion 80 x 16 mm
M 1321	145	Fabric tension extrusion 45°
M 1322	144	Fabric tension extrusion
M 1322/E	145	Fabric tension extrusion, external corner
M 1322/I	145	Fabric tension extrusion, internal corner
M 1324	166	Fabric suspension extrusion 33.5 mm
M 1325	142	Fabric tension extrusion 80 mm
M 1326	156	Connection extrusion
M 1327	291	Threaded plate M8/M6
M 1328	144	Adaptor
M 1330	142	Fabric tension extrusion 120 mm
M 1332	156	Fabric tension extrusion for cube elements
M 1334	156	Internal corner connector
M 1335	154	Internal corner connector
M 1336	154	Connector plate
M 1337	155	Screw eye
M 1338	155	Threaded plate
M 1339	146	Fixing clip
M 1340	41	Beam extrusion 120 x 16 mm
M 1341	238	3-way panel retainer
M 1343	239	3-Way Panel retainer
M 1344	239	Panel clip
M 1345	143	Fixing-set
M 1346	239	Panel clip
M 1347/SK	148	Fixing set
M 1348	146	Fixing set
M 1349	292	Threaded plate M8
M 1353	164	Fabric suspension beam extrusion 32 mm
M 1354	164	Fabric suspension beam extrusion 40 mm
M 1356	165	Fabric suspension beam extrusion 40 mm
M 1357	148	Base plate
M 1358	164	Fabric suspension extrusion
M 1359	165	Connector, straight
M 1360	164	Fabric suspension extrusion
M 1361	166	Fabric suspension extrusion
M 1363	166	Fabric suspension extrusion
M 1365/K	165	End cap
M 1365/KS	165	End cap with knurled-head screw
M 1366	242	Panel retainer, top
M 1367	248	Cover extrusion
M 1368	248	Cover extrusion
M 1369	296	Banner attachment set
M 1370	232	Glass retainer, 4 way
M 1375	232	Glass retainer, 3 way
M 1376	232	Glass retainer, 3 way
M 1380	231	Glass retainer, 2 way
M 1381	232	Glass retainer, 2 way
M 1382	235	Glass retainer 180°
M 1383	236	Glass retainer 90°
M 1384	236	Glass retainer 135°
M 1385	231	Glass retainer, single
M 1386	231	Glass retainer, single
M 1387	233	End screw
M 1390	236	Fixing angle
M 1391	234	Panel retainer
M 1392	234	Panel retainer
M 1393	235	Glass retainer
M 1395	233	Glass panel retainer "single"
M 1396	233	Glass panel retainer "double"
M 1397	233	Glass panel retainer "double"

INDEX

INDEX ARTICLE NUMBER

ARTICLE	PAGE	DESCRIPTION
M 1398	148	Base plate 320 x 120 mm
M 1401	19	Corner connector 80 mm
M 1402	311	Foot bracket
M 1402/Z	311	Glass supporting set
M 1404	311	Foot bracket
M 1406	306	Base plate 300 x 300 mm
M 1407	305	Base plate 300 x 300 mm
M 1408	305	Base plate 320 x 120 mm
M 1409	259	Spigot tube
M 1410	28	Corner connector 120 mm
M 1411	311	Foot bracket
M 1414	258	Spigot tube
M 1416	306	Base plate, adjustable 300 x 300 mm
M 1417	266	Straight Connector
M 1419	260	Spigot tube
M 1421	266	Straight Connector
M 1424	258	Spigot tube
M 1425	267	Straight Connector
M 1426	306	Base plate 450 x 450 mm
M 1430	259	Extrusion connector
M 1433	153	Holder
M 1434	153	Holder
M 1435	295	Connector part
M 1445	236	Glass retainer
M 1446	237	Glass retainer
M 1447	237	Glass retainer
M 1448	160	Fabric clip
M 1449	160	Fabric clip
M 1452	160	Fabric clip
M 1453	161	Fabric clip
M 1454	322	Display shelf rectangular
M 1456	238	Panel retainer
M 1457	254	Hinged set
M 1458	161	Round tube
M 1459	162	End cap
M 1460	295	Round tube
M 1461	58	End plate
M 1462	58	End plate
M 1465	58	End plate
M 1466	58	End plate
M 1467	237	Glass retainer
M 1468	162	Round tube
M 1469	59	Clamping set
M 1472	278	Hammerhead screw
M 1473	278	Hammerhead screw
M 1478	147	Fixing set
M 1479	161	End cap
M 1480	316	Long-arm floodlight
M 1481	316	Clamp for long-arm floodlight
M 1482	316	Clamp for long-arm floodlight
M 1483	249	Elliptical cover extrusion 40 mm
M 1485	251	Cable retaining extrusion
M 1486	249	Elliptical cover extrusion 60 mm
M 1488	250	Cable retaining clip
M 1489	250	Clip
M 1491	224	End cap 13 mm dia.
M 1492	237	Glas retainer
M 1493	249	End plate
M 1495	249	End plate
M 1498	316	LED Long-arm floodlight with adaptor

INDEX

INDEX ARTICLE NUMBER

ARTICLE PAGE DESCRIPTION

ARTICLE	PAGE	DESCRIPTION
M 1502	67	Louver extrusion
M 1503	67	Louver extrusion
M 1510	67	End plate
M 1515	67	Fixing set
M 1540	60	Hinged end plate
M 1541	60	Hinged end plate
M 1550	60	Hinged end plate
M 1551	60	Hinged end plate
M 1555	61	Adaptor for hinged end plate
M 1557	61	Hinged flange plate
M 1558	61	Cover cylinder set
M 1561	178	Wall panel retainer "top"
M 1562	178	Wall panel retainer "top"
M 1563	178	Wall panel retainer "top"
M 1567	178	Wall panel retainer "centre"
M 1568	179	Wall panel retainer "centre"
M 1571	179	Wall panel retainer "bottom"
M 1572	179	Wall panel retainer "top"
M 1575	180	Panel retainer
M 1577	180	Wall panel retainer "centre"
M 1579	61	Hinged end plate with eyelet
M 1580	238	Panel retainer with slot
M 1581	180	Wall panel retainer "bottom"
M 1582	314	Front suspension bar
M 1584	315	Front suspension bar - stairshape
M 1586	282	Bracket for glass shelf
M 1599	62	Anti-slipping device
M 1600	198	Quarter-round extrusion
M 1601	151	Fabric suspension extrusion
M 1602	217	Beam extrusion 25 mm
M 1603	217	Beam extrusion 25 mm
M 1606	199	Semi-circular extrusion
M 1607	152	Fabric tension extrusion
M 1609	225	Tension lock
M 1610	217	Clamping element
M 1614	151	Fabric tension extrusion
M 1616	343	Hex-star driver T25
M 1618	207	Square extrusion 18 mm
M 1619	152	Internal corner connector
M 1620	199	Quarter-round extrusion
M 1622	204	Triangular extrusion
M 1624	151	Holder
M 1625	208	Square extrusion 22 mm
M 1629	213	Exterior corner extrusion 135°
M 1630	198	End cap
M 1631	207	End cap
M 1632	198	Knuckle joint
M 1633	198	Knuckle joint
M 1635	302	Threaded plate M10
M 1636	292	Threaded plate
M 1637	269	Glass door hinge
M 1638	272	Handle
M 1639	207	Coupling pin
M 1643	246	Anti-rattle strip
M 1644	246	Anti-rattle strip
M 1650	204	End plate
M 1653	204	Knuckle joint
M 1655	151	Steel plate
M 1660	199	End cap
M 1662	199	Knuckle joint

INDEX

INDEX ARTICLE NUMBER

ARTICLE	PAGE	DESCRIPTION
M 1665	208	End cap
M 1670	281	Shelf support
M 1671	281	Shelf support
M 1683	208	Knuckle joint
M 1685	213	End plate
M 1689	213	Knuckle joint 135°
M 1692	200	Knuckle joint
M 1693	200	Knuckle joint
M 1800	94	Light wall extrusion
M 1810	94	Light wall upright extrusion
M 1825	95	Light wall beam
M 1835	95	End plate
M 1836	95	Adjustable foot
M 1837	96	Adjustable foot - base plate
M 1839	96	Base plate
M 1844	96	Cover extrusion
M 1846	97	Cover extrusion
M 1850	97	Cable retaining clip
M 1852	97	Internal corner connector
M 1855	98	Shim
M 1870	97	Connecting extrusion
M 1875	98	Connector extrusion
M 1905	158	Fabric extrusion for light box
M 1910	157	Fabric extrusion for light box
M 1911	159	Internal corner connector
M 1920	157	Fabric extrusion for light box
M 1926	158	Internal corner connector
M 1927	152	Internal corner connector
M 1927	158	Internal corner connector
M 1941	149	Base plate 495 x 170 mm
M 1942	149	Base plate 495 x 170 mm
M 1943	149	Base plate 495 x 170 mm
M 1951	150	Base plate 600 x 250 mm
M 1952	150	Base plate 600 x 250 mm
M 1953	150	Base plate 600 x 250 mm
M 2020	21	Square extrusion 80 mm
MF 1	170	Assembly handle
MF 4	167	Magnetic wall retainer
MF 12	167	Magnetic wall retainer
MF 15	167	Magnetic wall retainer
MF 21	167	Magnet single dispenser arm "light"
MF 60	170	Brochure shelf
MF 64	170	Brochure shelf
MF 80	171	Steel plate
MF 82	171	Steel plate
MF 100	171	Steel plate with 2 beams
MF 105	171	Steel plate with 2 beams
MF 125 G	169	Glass Shelf
MF 125 P	169	Wood Shelf
MF 150 G	169	Glass Shelf
MF 150 P	170	Wood Shelf
MF 202 S	168	Hanging arm / sloping
MF 204 S	168	Hanging arm / Straight
MF 207 S	168	Single dispenser arm
MF 209 S	168	Single dispenser arm
MF 226 S	168	Looped dispenser arm
MF 233 S	169	Display ring
MF 306 S	169	Bracket / straight
P 478	185	Distance piece
P 488	185	Distance piece

INDEX

INDEX ARTICLE NUMBER

ARTICLE	PAGE	DESCRIPTION
P 700	185	Shelf brackets, straight
P 705	186	Shelf bracket, adjustable
P 710	186	Shelf brackets, straight
P 720	186	Shelf brackets, straight
P 725	186	Shelf brackets, adjustable
P 730	187	Shelf brackets, straight
P 735	187	Shelf brackets, adjustable
P 740	187	Shelf brackets, straight
P 750	187	Shelf brackets, straight
P 780	188	Shelf brackets, straight
P 800	189	Clothes rail
P 806	189	Clothes rail
P 810	189	Clothes rail
P 816	190	Clothes rail
P 820	191	Hanging arm / straight
P 840	190	Hanging arm / straight
P 845	190	Hanging arm / stepped
P 850	190	Hanging arm / sloping
P 880	188	Clothes rail
P 886	188	Clothes rail
P 889	189	Fixing-set
P 890	188	Clothes rail
P 950	191	Postforming wooden shelf
P 950-062	191	Postforming wooden shelf
P 950-100	192	Postforming wooden shelf
P 950-125	192	Postforming wooden shelf
P 950-200	192	Postforming wooden shelf
P-1	323	Literature rack
P-2	323	Literature rack
P-3	323	Literature rack
P-4A	323	Literature rack
P-4W	323	Literature rack - wall version
P-8D	324	Literature rack
PS-0	336	Pneumatic press
P-ZZ6	324	Literature rack
S 100	102	Upright extrusion
S 108	102	Upright extrusion
S 110	102	Upright
S 118	103	Upright
S 128	104	Ceiling beam connector, 175 mm
S 132	103	End cap
S 135	104	Adaptor
S 137	265	Connector for upright extrusion
S 137/K	291	Threaded plug
S 140	103	Adjustable foot
S 140	110	Adjustable foot
S 141	307	Trumpet base
S 142	312	Pedestal base
S 144	312	Pedestal base 425 mm
S 146	312	Pedestal base 700 mm
S 150	307	Base plate
S 151	307	Intermediate washer
S 201	104	Upright extrusion
S 202	105	Upright extrusion
S 203	106	Upright extrusion 135°
S 204	242	Wall insert extrusion
S 206	111	Interior corner extrusion 45°
S 208	15	Upright extrusion
S 209	15	Upright extrusion
S 230	104	End cap

INDEX

INDEX ARTICLE NUMBER

ARTICLE

PAGE

DESCRIPTION

S 232	105	End plate
S 233	106	End plate
S 236	112	End plate
S 240	105	Adjustable foot
S 242	105	Adjustable foot
S 243	106	Adjustable foot
S 250	134	Hinged extrusion 35 mm
S 251	134	Hinged extrusion 24 mm
S 252	135	Hinged extrusion 16 mm
S 253	137	Hinged extrusion
S 255	134	End cap
S 257	134	End cap
S 258	137	End cap
S 260	135	Hinged connector
S 261	135	Threaded insert
S 262	135	Coupling spigot
S 263	136	Hinged connector
S 264	136	Hinged connector
S 266	136	Hinged connector
S 270	136	Adjustable foot
S 271	137	Retaining ring
S 272	138	Adjustable foot
S 280		fabric tension hinged extrusion
S 280		fabric tension hinged extrusion
S 302	107	Upright extrusion 45°
S 303	108	Upright extrusion 60°
S 308	106	Upright extrusion
S 330	107	End cap
S 332	107	End plate
S 333	108	End cap
S 340	107	Adjustable foot
S 342	108	Adjustable foot
S 343	108	Adjustable foot
S 380	15	Upright extrusion
S 408	109	Upright extrusion
S 430	109	End plate
S 440	109	Adjustable foot
S 500	111	Upright extrusion 60°
S 530	111	End cap
S 540	111	Adjustable foot
S 745	303	Castor
S 746	303	Castor
S 748	304	Clamping pin
S 800	112	Round extrusion 60 mm
S 805	112	Elliptical extrusion 60 x 40 mm
S 810	113	Square extrusion
S 815	113	Rectangular extrusion 60 x 40 mm
S 816	113	Rectangular extrusion 60 x 40 mm
S 822	114	Cover extrusion
S 824	114	Cover extrusion
S 830	112	End plate
S 832	113	End plate
S 834	113	End plate
S 836	114	End plate
S 842	114	Adjustable foot
S 850	110	Upright extrusion
S 855	110	Upright extrusion
S 901	103	Foot plate
S 905	265	Extension spigot
S 1100	201	Quarter-round extrusion

INDEX

INDEX ARTICLE NUMBER

ARTICLE	PAGE	DESCRIPTION
S 1105	201	Quarter-round extrusion
S 1106	201	Semi-circular extrusion
S 1125	210	Square extrusion 32 mm
S 1129	214	Exterior corner extrusion 135°
S 1130	201	End cap
S 1131	202	End plate
S 1132	202	Threaded insert
S 1133	291	Threaded insert
S 1140	303	Adjustable foot
S 1141	303	Adjustable foot
S 1142	210	End plate
S 1148	214	End plate
S 1150	260	Internal corner connector
S 1151	266	Connector
S 1154	265	Clip
S 1155	255	Internal connector
S 1156	261	Internal corner connector
S 1170	202	Knuckle joint
S 1171	203	Knuckle joint
S 1173	202	Knuckle joint
S 1175	211	Knuckle joint
S 1179	214	Knuckle joint 135°
S 1180	211	Knuckle joint
S 1181	266	Coupling pin
S 1190	211	Knuckle joint
S 1192	210	Knuckle joint
S 1200	200	Quarter-round extrusion
S 1225	280	Shelf support 10 mm dia.
S 1226	281	Shelf support 8 mm dia.
S 1230	200	End cap
S 1240	281	Shelf support
S 1303	204	Triangular extrusion
S 1310	205	Triangular extrusion
S 1332	205	Knuckle joint
S 1333	206	Knuckle joint
S 1334	205	End plate
S 1335	302	Threaded plate M10
S 1336	205	Threaded insert
S 1338	206	Knuckle joint 135°
S 1339	215	Knuckle joint 135°
S 1340	211	Knuckle joint
S 1341	212	Knuckle joint
S 1345	302	Threaded plate 135°
S 2305	49	Oval extrusion "open" 230 x 40 mm
S 2330	50	End plate
S 4330	299	Distance piece
S 4331	299	Distance piece
S 6035	293	Angle
S 6104	193	Elliptical extrusion
S 6105	193	Elliptical extrusion
S 6110	193	Insert extrusion
S 6130	193	End plate
S 6132	194	End plate
S 6200	194	Slotted insert rail
S 6218	194	Bracket for wooden shelves
S 6220	195	Bracket for glass shelf
V 2000	208	Square extrusion 25 mm
V 2020	213	Exterior corner extrusion 135°
V 2070	209	Knuckle joint
V 2100	209	Frame extrusion (external)

INDEX

INDEX ARTICLE NUMBER

ARTICLE	PAGE	DESCRIPTION
V 2200	209	Knuckle joint
V 2202	214	Knuckle joint 135°
V 2214	209	Adjustable foot
V 2214	302	Adjustable foot
V 2220	282	Shelf support
V 2222	282	Shelf support
V 2225	269	Glass door hinge
V 2226	272	Glass door lock
V 2234	210	Fixing clip
V 2236	210	Fixing clip
VA 1240	321	Brochure shelf universal
VA 5000	267	Straight connector
VA 5032	322	Brochure shelf, right
VA 5036	322	Brochure shelf, left
VA 5076	322	Display shelf
VA 5514	320	Monitor pole set 20" - 32"
VA 5524	320	Monitor pole set
VA 8804PW	324	Portable literature rack with transport bag
VA 8808PW	325	Portable literature rack with Transport bag
VA 8834	325	Transport bag
VA 8838	325	Transport bag
VA 8842	324	Portable literature rack
VA 8882	325	Portable literature rack
W 101	174	Beam extrusion 50 mm
W 102	175	Beam extrusion 50 mm
W 103	174	Beam extrusion 70 mm
W 105	177	Connecting spline
W 108	177	Panel retainer, on top
W 109	177	Panel retainer
W 115/G	174	Beam 50 mm
W 116/G	175	Beam 50 mm
W 117/G	175	Beam 50 mm
W 118/G	175	Beam 50 mm
W 125/G	176	Beam 50 mm
W 126/G	176	Beam 50 mm
W 127/G	176	Beam 50 mm
W 416	242	Insert extrusion
W 501	326	Glass door set right
W 501/GS	327	Handle- and lock set
W 501/T	327	Glass door panel
W 501/TG	327	Hinge set
W 501/Z	326	Glass door frame right
W 502	326	Glass door set left
W 502/Z	326	Glass door beam frame left
W 505	327	Glass door set DIN right/left
W 505/GS	328	Handle- and lock set
W 505/T	328	Glass door panel
W 505/TG	328	Hinge set
W 505/Z	328	Glass door beam frame
W 510/T	329	Door panel right
W 510/Z	329	Door frame, universal
W 511/T	329	Door panel left
W 512	331	Door handle set
W 513/L	331	Mortise lock DIN left
W 513/R	332	Mortise lock DIN right
W 514	332	Dead lock cylinder
W 524	332	Threshold plate
W 524/A	332	Add-on threshold plate
W 525	333	Folding door
W 540	333	Kit for beam door frame

INDEX

INDEX ARTICLE NUMBER

ARTICLE	PAGE	DESCRIPTION
W 541	333	Kit for beam door frame
W 580/T	330	Door panel right
W 580/Z	329	Door frame, universal
W 581/T	330	Door panel left
W 582	330	Door handle set
W 584PZ	331	Door handle set
W 585	330	Threshold seal
W 599	331	Drilling jig
W 810	247	Cover extrusion
W 908	17	Hinged extrusion
W 908	137	Hinged extrusion
W 910	247	Cover extrusion
WPS 1	336	Interchangeable sub-press
WPS 2	336	Interchangeable sub-press
WPS 5	336	Interchangeable sub-press
Z 100	118	Beam extrusion 43 mm
Z 110	123	Beam extrusion 70 mm
Z 115	123	Beam 455 x 70 mm
Z 116	125	Beam 455 x 70 mm
Z 120	124	Beam 660 x 70 mm
Z 121	126	Beam 660 x 70 mm
Z 125	124	Beam 950 x 70 mm
Z 126	126	Beam 950 x 70 mm
Z 130	124	Beam 1360 x 70 mm
Z 131	126	Beam 1360 x 70 mm
Z 140	126	Curved beam - quarter circle 990 x 70 mm
Z 141	127	Curved beam - quarter circle 1400 x 70 mm
Z 150	124	Curved beam - quarter circle 990 x 70 mm
Z 151	125	Curved beam - quarter circle 1400 x 70 mm
Z 152	125	Curved beam - quarter circle 1980 x 70 mm
Z 160	125	Beam extrusion 70 mm
Z 161/A	224	Adaptor for tension lock
Z 165	262	Internal corner connector
Z 166	262	Internal corner connector
Z 167	256	Internal connector
Z 169	127	Universal suspension connector
Z 170	118	End cap
Z 175	123	End cap
Z 180	301	Adjustable beam foot
Z 185	255	Washer
Z 280		Fabric tension extrusion
Z 280		Fabric tension extrusion
Z 300	115	Beam extrusion 25 mm
Z 305	216	Beam extrusion 25 mm
Z 306	216	Beam extrusion 30 mm
Z 308	115	Beam extrusion 32 mm
Z 308	217	Beam extrusion 32 mm
Z 310	115	Beam extrusion 37 mm
Z 315	116	Beam 455 x 37 mm
Z 320	116	Beam 660 x 37 mm
Z 325	116	Beam 950 x 37 mm
Z 330	116	Beam 1360 x 37 mm
Z 350	117	Curved beam - quarter circle 990 x 37 mm
Z 351	117	Curved beam - quarter circle 1400 mm x 37 mm
Z 352	117	Curved beam - quarter circle 1980 x 37 mm
Z 353	117	Curved beam - quarter circle 2800 x 37 mm
Z 366	261	Internal corner connector
Z 400	118	Beam extrusion 50 mm
Z 402	118	Beam extrusion 50 mm
Z 415	119	Beam 455 x 50 mm

INDEX

INDEX ARTICLE NUMBER

ARTICLE	PAGE	DESCRIPTION
Z 416	121	Beam 455 x 50 mm
Z 420	119	Beam 660 x 50 mm
Z 421	121	Beam 660 x 50 mm
Z 425	119	Beam 950 x 50 mm
Z 426	122	Beam 950 x 50 mm
Z 430	120	Beam 1360 x 50 mm
Z 431	122	Beam 1360 x 50 mm
Z 440	122	Curved beam-quarter circle 990 x 50 mm
Z 441	122	Curved beam - quarter circle 1400 x 50 mm
Z 442	122	Curved beam - quarter circle 1980 x 50 mm
Z 443	123	Curved beam - quarter circle 2800 x 50 mm
Z 450	120	Curved beam - quarter circle 990 x 50 mm
Z 451	120	Curved beam - quarter circle 1400 x 50 mm
Z 452	120	Curved beam - quarter circle 1980 x 50 mm
Z 453	120	Curved beam - quarter circle 2800 x 50 mm
Z 460	121	Beam extrusion 50 mm
Z 508	127	Beam extrusion 175 mm
Z 514	128	Beam 455 x 175 mm
Z 516	130	Beam 455 x 175 mm
Z 519	128	Beam 660 x 175 mm
Z 521	130	Beam 660 x 175 mm
Z 524	128	Beam 950 x 175 mm
Z 526	131	Beam 950 x 175 mm
Z 529	128	Beam 1360 x 175 mm
Z 531	131	Beam 1360 x 175 mm
Z 560	130	Beam extrusion 175 mm
Z 590	129	Curved beam-quarter circle 990 x 175 mm
Z 591	129	Curved beam-quarter circle 1400 x 175 mm
Z 592	129	Curved beam-quarter circle 1980 x 175 mm
Z 593	129	Curved beam-quarter circle 2800 x 175 mm
Z 600	131	Beam extrusion 175 mm
Z 615	132	Beam 455 x 175 mm
Z 620	132	Beam 660 x 175 mm
Z 625	132	Beam 950 x 175 mm
Z 630	132	Beam 1360 x 175 mm
Z 910	254	Connector
Z 915	255	Connector
Z 940	229	Clamping element
Z 942	229	Clamping element
Z 943	230	Clamping element
Z 950	216	Clamping element
Z 950/D	216	Presspin
Z 951/13	225	Tension lock, 13 mm
Z 951/8	225	Tension lock, 8 mm
Z 953/20L	227	Tension lock 22.5°
Z 953/20R	228	Tension lock 22.5°
Z 953/L	227	Tension lock 22.5°
Z 953/R	227	Tension lock 22.5°
Z 960	226	Tension lock
Z 961/13	224	Tension lock, 13 mm
Z 961/8	224	Tension lock, 8 mm
Z 962/13	226	Curved beam tension lock, 13 mm
Z 962/8	226	Curved beam tension lock, 8 mm
Z 962/T	225	Tension lock
Z 963/20L	228	Tension lock 45°
Z 963/20R	229	Tension lock 45°
Z 963/L	228	Tension lock 45°
Z 963/R	228	Tension lock 45°
Z 964	262	Internal corner connector
Z 965	262	Internal corner connector

INDEX

INDEX ARTICLE NUMBER

ARTICLE	PAGE	DESCRIPTION
Z 966	261	Internal corner connector
Z 966/S	261	Internal corner connector
Z 966/V	261	Internal corner connector
Z 967	255	Internal connector straight
Z 969	133	Universal suspension connector
Z 970	115	End cap
Z 974	116	End cap
Z 975	119	End cap
Z 975	121	End cap
Z 976	115	End cap
Z 976	218	End cap
Z 977	256	Internal connector straight
Z 978	256	Internal connector straight
Z 980	301	Adjustable foot
Z 980/G	291	Threaded plug
Z 2100	219	Beam extrusion 40 mm
Z 2105	220	Beam extrusion 40 mm
Z 2131	220	End plate
Z 4100	218	Beam extrusion 40 mm
Z 4300	218	Beam extrusion 40 mm
Z 4400	41	Beam extrusion 40 x 16 mm
Z 4400	218	Beam extrusion 40 x 16 mm
Z 4401	219	Beam extrusion 40 mm
Z 4430	219	End cap
Z 4700	219	Rectangular extrusion 40 mm
ZBS 100	349	Drill guide bush 8 mm dia.
ZBS 102	349	Drill guide bush 13 mm dia.
ZBS 103	349	Drill guide bush 10 mm dia.
ZBS 104	349	Drill guide bush 12 mm dia.
ZBS 112	350	Twist drill 8 mm dia.
ZBS 113	351	Twist drill 9 mm dia.
ZBS 114	351	Twist drill 13 mm dia.
ZBS 115	352	Step drill 12/6.5 mm dia./90°
ZBS 115A	352	Depth stop ring
ZBS 115B	352	Step drill 12/6.5 mm dia./90°
ZBS 116	350	Twist drill 6.4 mm dia.
ZBS 117	350	Twist drill 8.9 mm dia.
ZBS 120	351	Countersink 12.4 mm dia./90°
ZBS 121	352	Countersink 16.5 mm dia./90°
ZBS 122	351	Countersink 9.7 mm dia./90°
ZBS 130	353	Machine handtap drill M10
ZBS 131	353	Machine handtap drill M8
ZBS 145	346	Supplementary set for BS 6
ZBS 150	350	Twist drill 8.5 mm dia.
ZBS 151	351	Twist drill 10 mm dia.
ZBS 152	350	Twist drill 6.2 mm dia.
ZBS 153	352	Step drill 10/5.3 mm dia./90°
ZPS 100	337	Foot-operated control valve
ZPS 101	337	Replacement mandrel 21/13
ZPS 102	337	Replacement mandrel 39/13
ZPS 103	337	Punch
ZPS 105	337	Punch
ZPS 107	338	Set of nylon supporting blocks
ZPS 107/11	338	Supporting block
ZPS 107/13	338	Supporting block
ZPS 107/14	338	Supporting block
ZPS 107/51	338	Supporting block

INDEX

INDEX ARTICLE DESCRIPTION

DESCRIPTION	ARTICLE	PAGE
3-way panel retainer	M 1341	238
3-Way Panel retainer	M 1343	239
Accessories-Set for BS 4	BS 4 ZS 1	345
Accessories-Set for BS 4	BS 4 ZS 2	345
Adaptor	M 1328	144
Adaptor	M 1285	52
Adaptor	M 1286	53
Adaptor	S 135	104
Adaptor for hinged end plate	M 1555	61
Adaptor for hinged end plate	M 1281	63
Adaptor for hinged end plate	M 1282	64
Adaptor for monitor 15" - 21"	E 185	318
Adaptor for monitor 15" - 21"	E 186	318
Adaptor for monitor 20" - 32"	E 188	319
Adaptor for tension lock	Z 161/A	224
Adaptor set	M 125	68
Adaptor with safety tension lock	M 1116	53
Adaptor with safety tension lock	M 1114	53
Adaptor with safety tension lock	M 1124	56
Adaptor with safety tension lock	M 1126	56
Adaptor with tension lock	M 1104/L	55
Adaptor with tension lock	M 1104/R	55
Adaptor with tension lock	M 1102	54
Adaptor with tension lock	M 1100	51
Adaptor with Tension lock	M 1101	51
Adaptor with Tension lock	M 1103	51
Adaptor with Tension lock	M 1151	22
Adaptor with tension lock	M 1291	52
Adaptor with tension lock	M 1122	55
Add-on threshold plate	W 524/A	332
Adjustable beam foot	Z 180	301
Adjustable connection flange	M 531	71
Adjustable foot	S 240	105
Adjustable foot	S 140	103
Adjustable foot	S 242	105
Adjustable foot	S 243	106
Adjustable foot	S 340	107
Adjustable foot	S 342	108
Adjustable foot	M 1836	95
Adjustable foot	M 285	31
Adjustable foot	M 1066	32
Adjustable foot	M 1216	34
Adjustable foot	M 1232	34
Adjustable foot	M 1038	24
Adjustable foot	M 1016	17
Adjustable foot	M 1067	18
Adjustable foot	M 1234	35
Adjustable foot	M 1086	44
Adjustable foot	M 1088	45
Adjustable foot	M 1098	47
Adjustable foot	M 1246	48
Adjustable foot	M 282	40
Adjustable foot	S 272	138
Adjustable foot	S 270	136
Adjustable foot	S 440	109
Adjustable foot	S 343	108
Adjustable foot	S 540	111
Adjustable foot	S 842	114
Adjustable foot	E 250	301
Adjustable foot	V 2214	209

INDEX

INDEX ARTICLE DESCRIPTION

DESCRIPTION	ARTICLE	PAGE
Adjustable foot	S 1140	303
Adjustable foot	S 1141	303
Adjustable foot	Z 980	301
Adjustable foot	S 140	103
Adjustable foot	V 2214	209
Adjustable foot - base plate	M 1837	96
Adjustable foot 135°	M 1096	27
Adjustable foot, 135° corner	C 441	17
Angle	S 6035	293
Angle for fixing of wire rope	M 1107	295
Angle reinforcement	M 1112	289
Angle reinforcement	M 1150	90
Angle reinforcement	M 1129	90
Angle reinforcement	M 1139	92
Angle reinforcement	M 1139	290
Angle reinforcement	M 1150	90
Angle reinforcement	M 1129	90
Anti-rattle extrusion	E 475/N	275
Anti-rattle strip	E 444	246
Anti-rattle strip	E 445	246
Anti-rattle strip	M 1643	246
Anti-rattle strip	M 1644	246
Anti-slipping device	M 1141	91
Anti-slipping device	M 1599	62
Anti-slipping device	M 1299	66
Assembly handle	MF 1	170
Bag holder	E 275	300
Banner attachment set	M 1369	296
Base plate	M 1357	148
Base plate	M 1839	96
Base plate	S 150	307
Base plate 335 mm dia.	M 1240	308
Base plate 300 x 300 mm	M 1407	305
Base plate 300 x 300 mm	M 1406	306
Base plate 320 x 120 mm	M 1408	305
Base plate 320 x 120 mm	M 1398	148
Base plate 335 mm dia.	M 1242	308
Base plate 400 mm dia.	M 1239	308
Base plate 450 x 450 mm	M 1426	306
Base plate 455 mm dia.	M 1238	309
Base plate 455 mm dia.	M 825	309
Base plate 455 mm dia.	M 824	309
Base plate 495 x 170 mm	M 1941	149
Base plate 495 x 170 mm	M 1942	149
Base plate 495 x 170 mm	M 1943	149
Base plate 600 x 250 mm	M 1951	150
Base plate 600 x 250 mm	M 1952	150
Base plate 600 x 250 mm	M 1953	150
Base plate for adjustable foot	M 1237	36
Base plate for adjustable foot	M 1037	24
Base plate for adjustable foot	M 1057	32
Base plate, adjustable 300 x 300 mm	M 1416	306
Beam 1360 x 175 mm	Z 529	128
Beam 1360 x 175 mm	Z 531	131
Beam 1360 x 175 mm	Z 630	132
Beam 1360 x 37 mm	Z 330	116
Beam 1360 x 50 mm	Z 430	120
Beam 1360 x 50 mm	Z 431	122
Beam 1360 x 70 mm	Z 130	124
Beam 1360 x 70 mm	Z 131	126

INDEX

INDEX ARTICLE DESCRIPTION

DESCRIPTION	ARTICLE	PAGE
Beam 455 x 175 mm	Z 514	128
Beam 455 x 175 mm	Z 516	130
Beam 455 x 175 mm	Z 615	132
Beam 455 x 37 mm	Z 315	116
Beam 455 x 50 mm	Z 416	121
Beam 455 x 50 mm	Z 415	119
Beam 455 x 70 mm	Z 115	123
Beam 455 x 70 mm	Z 116	125
Beam 50 mm	W 115/G	174
Beam 50 mm	W 116/G	175
Beam 50 mm	W 117/G	175
Beam 50 mm	W 118/G	175
Beam 50 mm	W 125/G	176
Beam 50 mm	W 126/G	176
Beam 50 mm	W 127/G	176
Beam 660 x 175 mm	Z 519	128
Beam 660 x 175 mm	Z 521	130
Beam 660 x 175 mm	Z 620	132
Beam 660 x 37 mm	Z 320	116
Beam 660 x 50 mm	Z 421	121
Beam 660 x 50 mm	Z 420	119
Beam 660 x 70 mm	Z 120	124
Beam 660 x 70 mm	Z 121	126
Beam 950 x 175 mm	Z 524	128
Beam 950 x 175 mm	Z 526	131
Beam 950 x 175 mm	Z 625	132
Beam 950 x 37 mm	Z 325	116
Beam 950 x 50 mm	Z 426	122
Beam 950 x 50 mm	Z 425	119
Beam 950 x 70 mm	Z 125	124
Beam 950 x 70 mm	Z 126	126
Beam extrusion	M 770	76
Beam extrusion 120 x 16 mm	M 1340	41
Beam extrusion 175 mm	Z 508	127
Beam extrusion 175 mm	Z 560	130
Beam extrusion 175 mm	Z 600	131
Beam extrusion 25 mm	Z 300	115
Beam extrusion 25 mm	M 1602	217
Beam extrusion 25 mm	M 1603	217
Beam extrusion 25 mm	Z 305	216
Beam extrusion 30 mm	Z 306	216
Beam extrusion 32 mm	Z 308	115
Beam extrusion 32 mm	Z 308	217
Beam extrusion 37 mm	Z 310	115
Beam extrusion 40 mm	Z 4100	218
Beam extrusion 40 mm	Z 4300	218
Beam extrusion 40 mm	Z 4401	219
Beam extrusion 40 mm	Z 2100	219
Beam extrusion 40 mm	Z 2105	220
Beam extrusion 40 x 16 mm	Z 4400	41
Beam extrusion 40 x 16 mm	Z 4400	218
Beam extrusion 43 mm	Z 100	118
Beam extrusion 50 mm	Z 402	118
Beam extrusion 50 mm	Z 400	118
Beam extrusion 50 mm	Z 460	121
Beam extrusion 50 mm	W 101	174
Beam extrusion 50 mm	W 102	175
Beam extrusion 70 mm	W 103	174
Beam extrusion 70 mm	Z 160	125
Beam extrusion 70 mm	Z 110	123

INDEX

INDEX ARTICLE DESCRIPTION

DESCRIPTION	ARTICLE	PAGE
Beam extrusion 80 x 16 mm	M 1320	41
Beam packing extrusion	K 970	360
Beam packing extrusion	K 971	360
Beam retainer	M 1108	52
Beam retainer	M 1106	54
Beam retainer	M 1125	56
Beam retainer	M 1105	54
Bracket / straight	MF 306 S	169
Bracket for glass shelf	M 1586	282
Bracket for glass shelf	E 719	282
Bracket for glass shelf	S 6220	195
Bracket for wire rope	M 1118	294
Bracket for wooden shelves	E 718	283
Bracket for wooden shelves	E 728	283
Bracket for wooden shelves	S 6218	194
Brackets / Straight 300 mm	E 735	287
Brochure shelf	MF 60	170
Brochure shelf	MF 64	170
Brochure shelf universal	VA 1240	321
Brochure shelf, left	VA 5036	322
Brochure shelf, right	VA 5032	322
Cable clamp	E 245	250
Cable retaining clip	M 1488	250
Cable retaining clip	M 1850	97
Cable retaining extrusion	E 460	250
Cable retaining extrusion	E 463	251
Cable retaining extrusion	M 1485	251
Case for beams 175 mm	K 940	357
Case for beams 175 mm	K 941	357
Case for beams 175 mm	K 942	357
Case for beams 175 mm	K 943	357
Case for beams 175 mm	K 952	357
Case for beams 37 mm	K 921	354
Case for beams 37 mm	K 923	354
Case for beams 50 mm	K 930	355
Case for beams 50 mm	K 931	355
Case for beams 50 mm	K 932	355
Case for beams 50 mm	K 933	355
Case for beams 70 mm	K 910	356
Case for beams 70 mm	K 911	356
Case for beams 70 mm	K 912	356
Case for beams 70 mm	K 913	356
Case for ceiling elements	K 990	358
Case for curved beams 175 mm	K 946	358
Case for curved beams 175 mm	K 947	358
Case for curved beams 37 mm	K 926	354
Case for curved beams 50 mm	K 937	355
Case for curved beams 70 mm	K 916	356
Case for upright extrusions	K 900	354
Castor	S 745	303
Castor	S 746	303
Ceiling beam connector, 175 mm	S 128	104
Ceiling panel retainer	E 225	139
Ceiling panel retainer	E 226	139
Center dividers for cases	K 984	359
Center dividers for cases	K 985	360
Clamp for long-arm floodlight	M 1481	316
Clamp for long-arm floodlight	M 1482	316
Clamping element	Z 940	229
Clamping element	Z 942	229

INDEX

INDEX ARTICLE DESCRIPTION

DESCRIPTION	ARTICLE	PAGE
Clamping element	Z 943	230
Clamping element	Z 950	216
Clamping element	M 1610	217
Clamping extrusion	E 476	276
Clamping extrusion	E 477	276
Clamping pin	S 748	304
Clamping set	M 1469	59
Cleaner	E 124	344
Clip	S 1154	265
Clip	E 470/C	274
Clip	M 1489	250
Clothes rail	P 886	188
Clothes rail	P 880	188
Clothes rail	P 890	188
Clothes rail	P 800	189
Clothes rail	P 806	189
Clothes rail	P 810	189
Clothes rail	P 816	190
Clothes rod	E 810	313
Clothes rod	E 811	313
Clothes rod bracket	E 804	313
Clothes rod extrusion	E 800	313
Coat hanger beam	E 815	313
Coat hanger beam	E 280	314
Coat hook	E 284	314
Coat hook	E 281	314
Connecting clamp	E 262	264
Connecting clamp	E 263	265
Connecting extrusion	M 1870	97
Connecting extrusion	M 1063	25
Connecting plate	M 1314	155
Connecting spline	W 105	177
Connection extrusion	M 1326	156
Connection extrusion	M 1311	143
Connection flange	M 661	75
Connector	Z 910	254
Connector	Z 915	255
Connector	S 1151	266
Connector "Bottom" 120 mm	M 1194	29
Connector "Bottom" 80 mm	M 1184	20
Connector "Centre" 120 mm	M 1192	29
Connector "Centre" 80 mm	M 1182	20
Connector "Top" 120 mm	M 1190	28
Connector "Top" 80 mm	M 1180	19
Connector extrusion	M 1875	98
Connector for upright extrusion	S 137	265
Connector head	M 110	68
Connector head	M 130	68
Connector part	M 1172	90
Connector part	M 1132	90
Connector part	M 1435	295
Connector part	M 1290	295
Connector part	M 1292	290
Connector part	M 1132	90
Connector part set	M 1079	26
Connector plate	M 1336	154
Connector, straight	M 1359	165
Corner connector 120 mm	M 1410	28
Corner connector 80 mm	M 1401	19
Corner connector 90° "horizontal"	M 520	71

INDEX

INDEX ARTICLE DESCRIPTION

DESCRIPTION	ARTICLE	PAGE
Countersink 12.4 mm dia./90°	ZBS 120	351
Countersink 16.5 mm dia./90°	ZBS 121	352
Countersink 9.7 mm dia./90°	ZBS 122	351
Coupling pin	M 1144	298
Coupling pin	S 1181	266
Coupling pin	M 1639	207
Coupling spigot	S 262	135
Cover cylinder set	M 1558	61
Cover cylinder set	M 1278	65
Cover extrusion	M 1844	96
Cover extrusion	M 1846	97
Cover extrusion	M 1155	22
Cover extrusion	M 1045	30
Cover extrusion	M 1046	31
Cover extrusion	S 822	114
Cover extrusion	S 824	114
Cover extrusion	E 458	247
Cover extrusion	W 910	247
Cover extrusion	W 810	247
Cover extrusion	M 1367	248
Cover extrusion	M 1368	248
Cover extrusion	M 1044	248
Cover extrusion, translucent	M 220	39
Curved beam - quarter circle 1400 mm x 37 mm	Z 351	117
Curved beam - quarter circle 1400 x 50 mm	Z 451	120
Curved beam - quarter circle 1400 x 50 mm	Z 441	122
Curved beam - quarter circle 1400 x 70 mm	Z 151	125
Curved beam - quarter circle 1400 x 70 mm	Z 141	127
Curved beam - quarter circle 1980 x 37 mm	Z 352	117
Curved beam - quarter circle 1980 x 50 mm	Z 452	120
Curved beam - quarter circle 1980 x 50 mm	Z 442	122
Curved beam - quarter circle 1980 x 70 mm	Z 152	125
Curved beam - quarter circle 2800 x 37 mm	Z 353	117
Curved beam - quarter circle 2800 x 50 mm	Z 453	120
Curved beam - quarter circle 2800 x 50 mm	Z 443	123
Curved beam - quarter circle 990 x 37 mm	Z 350	117
Curved beam - quarter circle 990 x 50 mm	Z 450	120
Curved beam - quarter circle 990 x 70 mm	Z 150	124
Curved beam - quarter circle 990 x 70 mm	Z 140	126
Curved beam tension lock, 13 mm	Z 962/13	226
Curved beam tension lock, 8 mm	Z 962/8	226
Curved beam-quarter circle 1400 x 175 mm	Z 591	129
Curved beam-quarter circle 1980 x 175 mm	Z 592	129
Curved beam-quarter circle 2800 x 175 mm	Z 593	129
Curved beam-quarter circle 990 x 175 mm	Z 590	129
Curved beam-quarter circle 990 x 50 mm	Z 440	122
Cut to length extrusion	M 1000-25 P1	184
Dead lock cylinder	W 514	332
Depth stop ring	ZBS 115A	352
DESIGNCENTER	1-DCENTER	367
Display ring	MF 233 S	169
Display shelf	VA 5076	322
Display shelf rectangular	M 1454	322
Distance piece	M 1146	254
Distance piece	S 4330	299
Distance piece	S 4331	299
Distance piece	P 488	185
Distance piece	P 478	185
Door frame, universal	W 510/Z	329
Door frame, universal	W 580/Z	329

INDEX

INDEX ARTICLE DESCRIPTION

DESCRIPTION	ARTICLE	PAGE
Door handle extrusion	E 410	273
Door handle extrusion	E 410/AI	273
Door handle set	W 582	330
Door handle set	W 584PZ	331
Door handle set	W 512	331
Door panel left	W 511/T	329
Door panel left	W 581/T	330
Door panel right	W 580/T	330
Door panel right	W 510/T	329
Door stopping extrusion	E 430	244
Door stopping extrusion	E 433	245
Double box ratcheting wrench	M 955	343
Double fluorescent light	D 171	317
Drapery glider	E 240	300
Drill guide bush 10 mm dia.	ZBS 103	349
Drill guide bush 12 mm dia	ZBS 104	349
Drill guide bush 13 mm dia.	ZBS 102	349
Drill guide bush 8 mm dia.	ZBS 100	349
Drilling jig	BS 4	345
Drilling jig	BS 5	346
Drilling jig	BS 6	346
Drilling jig	BS 8	346
Drilling jig	BS 9	347
Drilling jig	BS 13	347
Drilling jig	BS 14	347
Drilling jig	BS 30	347
Drilling jig	BS 31	347
Drilling jig	BS 32	348
Drilling jig	BS 33	348
Drilling jig	BS 34	348
Drilling jig	BS 35	348
Drilling jig	BS 36	349
Drilling jig	W 599	331
Edge protection	A 200	252
Electric distribution box	D 216	317
Electric distribution box	D 208/N	317
Elliptical cover extrusion 40 mm	M 1483	249
Elliptical cover extrusion 60 mm	M 1486	249
Elliptical extrusion	S 6104	193
Elliptical extrusion	S 6105	193
Elliptical extrusion 120 x 40 mm	M 1227	49
Elliptical extrusion 60 x 40 mm	S 805	112
Elliptical extrusion 80 x 40 mm	M 1225	48
End cap	M 1034	23
End cap	M 1014	16
End cap	S 132	103
End cap	S 333	108
End cap	S 330	107
End cap	S 230	104
End cap	Z 974	116
End cap	Z 976	115
End cap	Z 970	115
End cap	S 530	111
End cap	Z 175	123
End cap	Z 975	119
End cap	Z 975	121
End cap	Z 170	118
End cap	S 258	137
End cap	S 257	134
End cap	S 255	134

INDEX

INDEX ARTICLE DESCRIPTION

DESCRIPTION	ARTICLE	PAGE
End cap	M 1660	199
End cap	M 1630	198
End cap	S 1230	200
End cap	S 1130	201
End cap	Z 976	115
End cap	Z 4430	219
End cap	M 1665	208
End cap	M 1631	207
End cap	M 1479	161
End cap	M 1459	162
End cap	M 1365/K	165
End cap	E 318	288
End cap	E 708/K	284
End cap	E 710/K	284
End cap	M 1149	298
End cap 13 mm dia.	M 1491	224
End cap with knurled-head screw	M 1365/KS	165
End dividers for cases	K 981	359
End dividers for cases	K 982	359
End dividers for cases	K 983	359
End piece	E 474	275
End plate	M 1495	249
End plate	M 1493	249
End plate	S 836	114
End plate	S 430	109
End plate	S 236	112
End plate	S 832	113
End plate	S 830	112
End plate	S 834	113
End plate	S 1334	205
End plate	S 1148	214
End plate	S 1142	210
End plate	M 1685	213
End plate	Z 2131	220
End plate	S 1131	202
End plate	M 1650	204
End plate	S 6130	193
End plate	S 6132	194
End plate	M 1015	16
End plate	S 232	105
End plate	S 233	106
End plate	S 332	107
End plate	M 1835	95
End plate	M 1510	67
End plate	M 1461	58
End plate	M 1465	58
End plate	M 1462	58
End plate	M 1466	58
End plate	M 1015	16
End plate	M 1065	18
End plate	M 1035	23
End plate	M 274	31
End plate	M 1215	33
End plate	M 1245	48
End plate	M 1085	44
End plate	M 1087	45
End plate	M 1099	42
End plate	M 270	39
End plate	M 1231	34
End plate	M 1235	35

INDEX

INDEX ARTICLE DESCRIPTION

DESCRIPTION	ARTICLE	PAGE
End plate	M 1097	46
End plate	S 2330	50
End plate 135°	M 1095	27
End screw	M 1387	233
Extension spigot	S 905	265
Exterior corner extrusion 135°	S 1129	214
Exterior corner extrusion 135°	M 1629	213
Exterior corner extrusion 135°	V 2020	213
Exterior corner extrusion 135°	M 1070	26
Exterior corner extrusion 135°	M 1009	17
Extrusion connector	M 1230	257
Extrusion connector	M 1205	257
Extrusion connector	M 1430	259
Extrusion connector	E 438	253
Extrusion connector	E 450	253
Extrusion connector	E 451	253
Extrusion connector	E 452	253
Extrusion for inner partition	K 980	358
Fabric clip	M 1448	160
Fabric clip	M 1449	160
Fabric clip	M 1452	160
Fabric clip	M 1453	161
Fabric extrusion for light box	M 1905	158
Fabric extrusion for light box	M 1910	157
Fabric extrusion for light box	M 1920	157
Fabric suspension beam extrusion 32 mm	M 1353	164
Fabric suspension beam extrusion 40 mm	M 1354	164
Fabric suspension beam extrusion 40 mm	M 1356	165
Fabric suspension extrusion	M 1360	164
Fabric suspension extrusion	M 1358	164
Fabric suspension extrusion	M 1361	166
Fabric suspension extrusion	M 1363	166
Fabric suspension extrusion	M 1601	151
Fabric suspension extrusion 33.5 mm	M 1324	166
Fabric tension extrusion	M 1302	153
Fabric tension extrusion	Z 280	
Fabric tension extrusion	M 1309	152
Fabric tension extrusion	M 1304	147
Fabric tension extrusion	M 1607	152
Fabric tension extrusion	M 1307	147
Fabric tension extrusion	M 1614	151
Fabric tension extrusion	M 1322	144
Fabric tension extrusion	M 1319	146
Fabric tension extrusion	Z 280	
Fabric tension extrusion 120 mm	M 1330	142
Fabric tension extrusion 40 mm	M 1310	142
Fabric tension extrusion 40 mm	M 1305	146
Fabric tension extrusion 45°	M 1321	145
Fabric tension extrusion 80 mm	M 1325	142
Fabric tension extrusion for cube elements	M 1332	156
Fabric tension extrusion, external corner	M 1322/E	145
Fabric tension extrusion, internal corner	M 1322/I	145
fabric tension hinged extrusion	S 280	
fabric tension hinged extrusion	S 280	
Fascia hook	E 220	240
Fascia hook	E 220/S	240
Fascia hook	M 1050	241
Fixing angle	M 1117	181
Fixing angle	M 1160	294
Fixing angle	M 1390	236

INDEX

INDEX ARTICLE DESCRIPTION

DESCRIPTION	ARTICLE	PAGE
Fixing angle	M 1117	181
Fixing angle	M 536	72
Fixing clip	V 2234	210
Fixing clip	V 2236	210
Fixing clip	M 1339	146
Fixing set	M 1348	146
Fixing set	M 1478	147
Fixing set	M 1347/SK	148
Fixing set	M 1515	67
Fixing set	M 1089	26
Fixing-set	P 889	189
Fixing-set	M 1345	143
Fixing-set	M 1147	298
Flange for truss beam	M 500	70
Flange for truss beam	M 510	71
Flat rubber	E 480	276
Flat truss beam	M 703	76
Flat truss beam	M 704	76
Flat truss beam	M 705	77
Flat truss beam	M 706	77
Flat truss beam	M 640	74
Flat truss beam	M 641	74
Flat truss beam	M 650	74
Flat truss beam	M 651	75
Flat truss beam adaptor	M 755	77
Folding door	W 525	333
Foot bracket	M 1402	311
Foot bracket	M 1404	311
Foot bracket	M 1411	311
Foot plate	S 901	103
Foot-operated control valve	ZPS 100	337
Frame extrusion (external)	V 2100	209
Front suspension bar	M 1582	314
Front suspension bar - stairshape	M 1584	315
Glas retainer	M 1492	237
Glass door beam frame	W 505/Z	328
Glass door beam frame left	W 502/Z	326
Glass door frame right	W 501/Z	326
Glass door hinge	E 297	268
Glass door hinge	E 297/M	268
Glass door hinge	V 2225	269
Glass door hinge	M 1637	269
Glass door lock	V 2226	272
Glass door panel	W 501/T	327
Glass door panel	W 505/T	328
Glass door set DIN right/left	W 505	327
Glass door set left	W 502	326
Glass door set right	W 501	326
Glass frame extrusion	E 440	245
Glass panel retainer	E 420	243
Glass panel retainer	E 421	244
Glass panel retainer	E 422	244
Glass panel retainer	E 424	243
Glass panel retainer "double"	M 1396	233
Glass panel retainer "double"	M 1397	233
Glass panel retainer "single"	M 1395	233
Glass retainer	M 1445	236
Glass retainer	M 1446	237
Glass retainer	M 1447	237
Glass retainer	M 1467	237

INDEX

INDEX ARTICLE DESCRIPTION

DESCRIPTION	ARTICLE	PAGE
Glass retainer	M 1393	235
Glass retainer	E 443	243
Glass retainer 135°	M 1384	236
Glass retainer 180°	M 1382	235
Glass retainer 90°	M 1383	236
Glass retainer, 2 way	M 1380	231
Glass retainer, 2 way	M 1381	232
Glass retainer, 3 way	M 1375	232
Glass retainer, 3 way	M 1376	232
Glass retainer, 4 way	M 1370	232
Glass retainer, single	M 1385	231
Glass retainer, single	M 1386	231
Glass Shelf	MF 125 G	169
Glass Shelf	MF 150 G	169
Glass supporting set	M 1402/Z	311
Glide handle	E 481	277
Graphic panel retainer	E 271	239
Graphic panel retainer	E 273	240
Groove filler	E 455	247
Hammerhead bolt	M 1142	297
Hammerhead bolt	M 1145	297
Hammerhead screw	M 1472	278
Hammerhead screw	M 1473	278
Hammerhead screw	M 812	278
Hammerhead screw	E 265	278
Hammerhead screw	E 203	279
Hammerhead screw	E 205	279
Hammerhead screw	E 207	279
Hammerhead screw	E 209	279
Hammerhead screw	E 210	279
Hammerhead screw	E 210/M8	280
Handle	M 1638	272
Handle- and lock set	W 505/GS	328
Handle- and lock set	W 501/GS	327
Hanging arm / sloping	MF 202 S	168
Hanging arm / sloping	P 850	190
Hanging arm / stepped	P 845	190
Hanging arm / straight	P 840	190
Hanging arm / straight	P 820	191
Hanging arm / Straight	MF 204 S	168
Hexagon screwdriver	E 131	341
Hexagon screwdriver	E 132	341
Hexagon wrench set	E 117	340
Hex-star driver	E 13	339
Hex-star driver T25	M 1616	343
Hex-star driver T30	E 14	339
Hex-star driver T30	E 113	339
Hex-star driver T30	M 940	341
Hex-star head attachment 1/4", T30	M 945	342
Hex-star head attachment 1/4", T30	E 116	340
Hex-star head attachment 1/4", T30	E 116/42	340
Hex-star wrench	E 114	339
Hinge	E 305	271
Hinge pin	E 310	271
Hinge plate	E 296/L	269
Hinge plate	E 296/R	269
Hinge plate	E 300	270
Hinge plate	E 306	270
Hinge plate	E 290	268
Hinge plate	E 290/D	268

INDEX

INDEX ARTICLE DESCRIPTION

DESCRIPTION	ARTICLE	PAGE
Hinge plate left	E 307/L	270
Hinge plate right	E 307/R	271
Hinge set	W 501/TG	327
Hinge set	W 505/TG	328
Hinged bolt lock	E 291	272
Hinged bolt lock	E 292	272
Hinged clamp	M 827	77
Hinged connector	S 260	135
Hinged connector	S 263	136
Hinged connector	S 264	136
Hinged connector	S 266	136
Hinged end plate	M 1265	63
Hinged end plate	M 1255	64
Hinged end plate	M 1258	64
Hinged end plate	M 1541	60
Hinged end plate	M 1540	60
Hinged end plate	M 1551	60
Hinged end plate	M 1550	60
Hinged end plate	M 1295	62
Hinged end plate	M 1296	62
Hinged end plate	M 1260	63
Hinged end plate	M 1250	63
Hinged end plate with eyelet	M 1579	61
Hinged extrusion	S 253	137
Hinged extrusion	W 908	17
Hinged extrusion	W 908	137
Hinged extrusion 16 mm	S 252	135
Hinged extrusion 24 mm	S 251	134
Hinged extrusion 35 mm	S 250	134
Hinged flange plate	M 1270	64
Hinged flange plate	M 1271	65
Hinged flange plate	M 1557	61
Hinged plate with eyelet	M 1279	66
Hinged set	M 1457	254
Holder	M 1624	151
Holder	M 1433	153
Holder	M 1434	153
Insert extrusion	W 416	242
Insert extrusion	S 6110	193
Insert piece	E 272	240
Interchangeable sub-press	WPS 1	336
Interchangeable sub-press	WPS 2	336
Interchangeable sub-press	WPS 5	336
Interior corner connector	E 702	283
Interior corner extrusion 45°	S 206	111
Intermediate layer	K 986	360
Intermediate washer	S 151	307
Internal connector	S 1155	255
Internal connector	Z 167	256
Internal connector straight	M 1064	257
Internal connector straight	M 1121	257
Internal connector straight	M 1123	258
Internal connector straight	Z 967	255
Internal connector straight	Z 977	256
Internal connector straight	Z 978	256
Internal connector straight	M 1131	259
Internal connector straight	M 1133	260
Internal connector straight	M 1181	22
Internal connector straight	M 1183	23
Internal corner connector	M 1852	97

INDEX

INDEX ARTICLE DESCRIPTION

DESCRIPTION	ARTICLE	PAGE
Internal corner connector	S 1150	260
Internal corner connector	S 1156	261
Internal corner connector	Z 366	261
Internal corner connector	Z 966	261
Internal corner connector	Z 966/S	261
Internal corner connector	Z 966/V	261
Internal corner connector	Z 965	262
Internal corner connector	Z 964	262
Internal corner connector	Z 165	262
Internal corner connector	Z 166	262
Internal corner connector	M 1111	264
Internal corner connector	M 1113	263
Internal corner connector	M 1115	263
Internal corner connector	M 1334	156
Internal corner connector	M 1335	154
Internal corner connector	M 1927	152
Internal corner connector	M 1926	158
Internal corner connector	M 1927	152
Internal corner connector	M 1911	159
Internal corner connector	M 1619	152
Internal corner connector 135°	E 282	263
Internal corner connector 135°	E 283	263
Kit for beam door frame	W 540	333
Kit for beam door frame	W 541	333
Knuckle joint	M 1632	198
Knuckle joint	M 1633	198
Knuckle joint	M 1662	199
Knuckle joint	M 1653	204
Knuckle joint	S 1173	202
Knuckle joint	S 1170	202
Knuckle joint	S 1171	203
Knuckle joint	M 1692	200
Knuckle joint	M 1693	200
Knuckle joint	V 2200	209
Knuckle joint	M 1683	208
Knuckle joint	S 1332	205
Knuckle joint	S 1333	206
Knuckle joint	V 2070	209
Knuckle joint	S 1192	210
Knuckle joint	S 1190	211
Knuckle joint	S 1175	211
Knuckle joint	S 1180	211
Knuckle joint	S 1340	211
Knuckle joint	S 1341	212
Knuckle joint	M 1073	16
Knuckle joint	A 220	252
Knuckle joint	A 230	252
Knuckle joint 135°	M 1689	213
Knuckle joint 135°	V 2202	214
Knuckle joint 135°	S 1179	214
Knuckle joint 135°	S 1339	215
Knuckle joint 135°	S 1338	206
LED Long-arm floodlight with adaptor	M 1498	316
Light wall beam	M 1825	95
Light wall extrusion	M 1800	94
Light wall upright extrusion	M 1810	94
Lighttrack mounting extrusion 80 mm	M 1058	21
Lighttrack mounting extrusion 80 mm	M 1059	22
Literature dispenser	E 277	321
Literature rack	E 286	321

INDEX

INDEX ARTICLE DESCRIPTION

DESCRIPTION	ARTICLE	PAGE
Literature rack	P-4A	323
Literature rack	P-1	323
Literature rack	P-2	323
Literature rack	P-3	323
Literature rack	P-ZZ6	324
Literature rack	P-8D	324
Literature rack - wall version	P-4W	323
Locking end piece	E 484	277
Locking plate	E 485	277
Long-arm floodlight	M 1480	316
Looped dispenser arm	MF 226 S	168
Louver extrusion	M 1502	67
Louver extrusion	M 1503	67
Low voltage spotlight	D 1145	317
Lower track for sliding doors	E 401	273
Machine handtap drill M10	ZBS 130	353
Machine handtap drill M8	ZBS 131	353
Magnet single dispenser arm "light"	MF 21	167
Magnetic wall retainer	MF 15	167
Magnetic wall retainer	MF 12	167
Magnetic wall retainer	MF 4	167
Monitor fixing set	E 191	319
Monitor fixing set	E 195	319
Monitor pole set	VA 5524	320
Monitor pole set 20" - 32"	VA 5514	320
Mortise lock DIN left	W 513/L	331
Mortise lock DIN right	W 513/R	332
Mounting tool set	M 900	341
OCTAcad	1-OCAD	365
OCTADesign	1-ODESIGN	364
OCTASHINE	E 120	343
OCTASHINE	E 120/P	343
OCTASNAP	1-OCTASNAP	366
Open ended spanner	E 119	340
Oval extrusion "open" 230 x 40 mm	S 2305	49
Packing strip	M 980	360
Panel clip	M 1346	239
Panel clip	M 1344	239
Panel retainer	M 1456	238
Panel retainer	E 221	288
Panel retainer	W 109	177
Panel retainer	M 1575	180
Panel retainer	M 1391	234
Panel retainer	M 1392	234
Panel retainer extrusion	E 428	243
Panel retainer with slot	M 1580	238
Panel retainer, on top	W 108	177
Panel retainer, top	M 1366	242
Pedestal base	S 142	312
Pedestal base 425 mm	S 144	312
Pedestal base 700 mm	S 146	312
Perforated ceiling grid	D 155	139
Pneumatic press	PS-0	336
Portable literature rack	VA 8842	324
Portable literature rack	VA 8882	325
Portable literature rack with transport bag	VA 8804PW	324
Portable literature rack with Transport bag	VA 8808PW	325
Postforming wooden shelf	P 950	191
Postforming wooden shelf	P 950-062	191
Postforming wooden shelf	P 950-100	192

INDEX

INDEX ARTICLE DESCRIPTION

DESCRIPTION	ARTICLE	PAGE
Postforming wooden shelf	P 950-125	192
Postforming wooden shelf	P 950-200	192
Presspin	Z 950/D	216
Punch	ZPS 103	337
Punch	ZPS 105	337
Quarter-round extrusion	M 1620	199
Quarter-round extrusion	M 1600	198
Quarter-round extrusion	S 1200	200
Quarter-round extrusion	S 1100	201
Quarter-round extrusion	S 1105	201
Quicklink	M 1137	91
Quicklink	M 1137	296
Ratchet 1/4"	E 115	339
Rectangular extrusion "open" 120 x 60 mm	M 1060	46
Rectangular extrusion 120 x 40 mm	M 1030	44
Rectangular extrusion 120 x 40 mm	M 1031	45
Rectangular extrusion 160 x 80 mm	M 1052	46
Rectangular extrusion 40 mm	Z 4700	219
Rectangular extrusion 40 x 28 mm	M 1068	41
Rectangular extrusion 40 x 28 mm	M 1069	42
Rectangular extrusion 60 x 40 mm	M 1082	42
Rectangular extrusion 60 x 40 mm	S 815	113
Rectangular extrusion 60 x 40 mm	S 816	113
Rectangular extrusion 80 x 40 mm	M 1025	42
Rectangular extrusion 80 x 40 mm	M 1026	43
Rectangular extrusion 80 x 40 mm	M 1091	43
Rectangular extrusion 80 x 40 mm	M 1092	43
Reinforcement extrusion	M 1110	31
Reinforcing plate	M 1164	93
Reinforcing plate	M 1134	93
Reinforcing plate	E 212	293
Reinforcing plate	E 213	293
Replacement key	E 479	276
Replacement mandrel 21/13	ZPS 101	337
Replacement mandrel 39/13	ZPS 102	337
Retaining ring	S 271	137
Roller	E 473	275
Roller	E 473/H	275
Roller blind beam	M 811	163
Roller blind beam	M 816	163
Round extrusion "open" 120 mm	M 215	38
Round extrusion "open" 120 mm	M 216	38
Round extrusion "open" 120 mm	M 217	39
Round extrusion 120 mm	M 205	37
Round extrusion 120 mm	M 206	37
Round extrusion 120 mm	M 207	38
Round extrusion 120 mm	M 235	36
Round extrusion 120 mm	M 236	36
Round extrusion 120 mm	M 237	36
Round extrusion 120 mm - 60°	M 245	37
Round extrusion 40 mm	M 1201	33
Round extrusion 40 mm	M 1202	33
Round extrusion 40 mm	M 1204	33
Round extrusion 60 mm	M 1210	34
Round extrusion 60 mm	S 800	112
Round extrusion 80 mm	M 1220	35
Round extrusion 80 mm	M 1222	35
Round tube	M 1468	162
Round tube	M 1458	161
Round tube	M 1140	296

INDEX

INDEX ARTICLE DESCRIPTION

DESCRIPTION	ARTICLE	PAGE
Round tube	M 1460	295
Rubber sponge bumper	E 441	245
Runner	E 471/N	274
Runner frame extrusion	E 472	275
Safety stop	M 826	310
Safety tension lock, left	M 1161/L	57
Safety tension lock, right	M 1161/R	57
Screw eye	M 1337	155
Screw eye	E 218	300
Screw hook	E 219	300
Screw set	M 1276	65
Screw Set	M 550	72
Screwdriver set	E 130	340
Semi-circular extrusion	S 1106	201
Semi-circular extrusion	M 1606	199
Set of nylon supporting blocks	ZPS 107	338
Shelf board	E 739	287
Shelf bracket	E 723	285
Shelf bracket	E 733	286
Shelf bracket	E 743	286
Shelf bracket	E 708	284
Shelf bracket 150 mm	E 710	284
Shelf bracket 200 mm	E 711	284
Shelf bracket 250 mm	E 712	285
Shelf bracket 30°	E 737	287
Shelf bracket 300 mm	E 713	285
Shelf bracket connector	E 720/G	285
Shelf bracket, adjustable	P 705	186
Shelf brackets, adjustable	P 725	186
Shelf brackets, adjustable	P 735	187
Shelf brackets, straight	P 740	187
Shelf brackets, straight	P 750	187
Shelf brackets, straight	P 780	188
Shelf brackets, straight	P 730	187
Shelf brackets, straight	P 710	186
Shelf brackets, straight	P 720	186
Shelf brackets, straight	P 700	185
Shelf extrusion	E 315	288
Shelf support	S 1240	281
Shelf support	M 1670	281
Shelf support	M 1671	281
Shelf support	V 2220	282
Shelf support	V 2222	282
Shelf support 10 mm dia.	S 1225	280
Shelf support 8 mm dia.	S 1226	281
Shim	M 1855	98
Silicone edge	M 1313	159
Single dispenser arm	MF 207 S	168
Single dispenser arm	MF 209 S	168
Sleeve	E 217	280
Slide-in shelf bracket	E 725	286
Slide-in shelf bracket 20°	E 726	286
Slide-in shelf bracket 30°	E 727	287
Sliding door extrusion	E 470/N	274
Sliding door lock	E 478	276
Sliding door lock	E 295/N	274
Sliding plane clamp	E 261	264
Slotted insert rail	S 6200	194
Spigot tube	M 1414	258
Spigot tube	M 1409	259

INDEX

INDEX ARTICLE DESCRIPTION

DESCRIPTION	ARTICLE	PAGE
Spigot tube	M 1419	260
Spigot tube	M 1424	258
Square extrusion	S 810	113
Square extrusion "open" 120 mm	M 1041	30
Square extrusion "open" 120 mm	M 1040	30
Square extrusion "open" 80 mm	M 1022	25
Square extrusion "open" 80 mm	M 1023	25
Square extrusion 120 mm	M 230	29
Square extrusion 120 mm	M 232	30
Square extrusion 120 mm	M 225	27
Square extrusion 120 mm	M 226	27
Square extrusion 120 mm	M 227	28
Square extrusion 18 mm	M 1618	207
Square extrusion 22 mm	M 1625	208
Square extrusion 25 mm	V 2000	208
Square extrusion 32 mm	S 1125	210
Square extrusion 40 mm	M 1000	14
Square extrusion 40 mm	M 1001	14
Square extrusion 40 mm	M 1002	14
Square extrusion 40 mm	M 1003	14
Square extrusion 40 mm	M 1005	14
Square extrusion 40 mm	M 1007	15
Square extrusion 60 mm	M 1010	18
Square extrusion 60 mm	M 1011	18
Square extrusion 80 mm	M 1020	19
Square extrusion 80 mm	M 1021	19
Square extrusion 80 mm	M 1012	24
Square extrusion 80 mm	M 1013	24
Square extrusion 80 mm	M 1018	20
Square extrusion 80 mm	M 1019	21
Square extrusion 80 mm	M 2020	21
Square extrusion 84 mm	M 1017	25
Stabilizing diagonal tube	M 535	72
Steel plate	M 1655	151
Steel plate	MF 80	171
Steel plate	MF 82	171
Steel plate with 2 beams	MF 100	171
Steel plate with 2 beams	MF 105	171
Steel wire with turnbuckle	M 1280	62
Steel wire with turnbuckle	M 1280	66
Step drill 10/5.3 mm dia./90°	ZBS 153	352
Step drill 12/6.5 mm dia./90°	ZBS 115	352
Step drill 12/6.5 mm dia./90°	ZBS 115B	352
Straight Connector	M 1417	266
Straight Connector	M 1421	266
Straight Connector	M 1425	267
Straight connector	VA 5000	267
Supplementary set for BS 6	ZBS 145	346
Supporting angle	E 211	280
Supporting block	ZPS 107/11	338
Supporting block	ZPS 107/13	338
Supporting block	ZPS 107/14	338
Supporting block	ZPS 107/51	338
Supporting edge	E 442	242
Suspension connector	M 555	72
Suspension connector	M 556	73
Suspension connector	M 655	75
Suspension plate	E 292/A	272
Tension brace junction knot	M 1262	91
Tension brace junction knot	M 1264	91

INDEX

INDEX ARTICLE DESCRIPTION

DESCRIPTION	ARTICLE	PAGE
Tension lock	Z 960	226
Tension lock	M 1609	225
Tension lock	Z 962/T	225
Tension lock 22.5°	Z 953/L	227
Tension lock 22.5°	Z 953/R	227
Tension lock 22.5°	Z 953/20L	227
Tension lock 22.5°	Z 953/20R	228
Tension lock 45°	Z 963/L	228
Tension lock 45°	Z 963/R	228
Tension lock 45°	Z 963/20L	228
Tension lock 45°	Z 963/20R	229
Tension lock, 13 mm	Z 951/13	225
Tension lock, 13 mm	Z 961/13	224
Tension lock, 8 mm	Z 961/8	224
Tension lock, 8 mm	Z 951/8	225
T-handle screwdriver	M 951	342
T-handle screwdriver	M 952	342
Threaded insert	S 1133	291
Threaded insert	S 261	135
Threaded insert	S 1336	205
Threaded insert	S 1132	202
Threaded insert M6	M 1138	297
Threaded plate	M 1078	292
Threaded plate	E 470/E	292
Threaded plate	M 1636	292
Threaded plate	M 1338	155
Threaded plate 135°	S 1345	302
Threaded plate M10	M 1635	302
Threaded plate M10	S 1335	302
Threaded plate M8	M 1349	292
Threaded plate M8/M6	M 1327	291
Threaded plug	S 137/K	291
Threaded plug	Z 980/G	291
Threshold plate	W 524	332
Threshold seal	W 585	330
Tie rod tensioning set / 10 axes	M 730	79
Tie rod tensioning set / 12 axes	M 732	79
Tie rod tensioning set / 14 axes	M 734	80
Tie rod tensioning set / 7 axes	M 727	78
Tie rod tensioning set / 8 axes	M 728	78
TRAINING	1-SCHULUNG	368
Transport bag	VA 8834	325
Transport bag	VA 8838	325
Triangular extrusion	M 1622	204
Triangular extrusion	S 1303	204
Triangular extrusion	S 1310	205
Triangular truss beam	M 440	69
Triangular truss beam	M 441	69
Triangular truss beam	M 450	70
Triangular truss beam	M 451	70
Trumpet base	S 141	307
Truss girder / 10 axes	M 740	82
Truss girder / 10 axes	M 750	85
Truss girder / 10 axes	M 760	87
Truss girder / 10 axes	M 780	88
Truss girder / 12 axes	M 742	82
Truss girder / 14 axes	M 744	83
Truss girder / 5 axes	M 785	89
Truss girder / 6 axes	M 786	89
Truss girder / 6 axes	M 776	87

INDEX

INDEX ARTICLE DESCRIPTION

DESCRIPTION	ARTICLE	PAGE
Truss girder / 6 axes	M 746	83
Truss girder / 6 axes	M 756	85
Truss girder / 7 axes	M 757	86
Truss girder / 7 axes	M 747	84
Truss girder / 7 axes	M 777	88
Truss girder / 7 axes	M 787	89
Truss girder / 7 axes	M 737	81
Truss girder / 8 axes	M 738	81
Truss girder / 8 axes	M 778	88
Truss girder / 8 axes	M 748	84
Truss girder / 8 axes	M 758	86
Twist drill 10 mm dia.	ZBS 151	351
Twist drill 13 mm dia.	ZBS 114	351
Twist drill 6.2 mm dia.	ZBS 152	350
Twist drill 6.4 mm dia.	ZBS 116	350
Twist drill 8 mm dia.	ZBS 112	350
Twist drill 8.5 mm dia.	ZBS 150	350
Twist drill 8.9 mm dia.	ZBS 117	350
Twist drill 9 mm dia.	ZBS 113	351
U-channel extrusion	M 1312	154
Universal suspension connector	Z 969	133
Universal suspension connector	Z 169	127
Upper track for sliding doors	E 400	273
Upright	S 118	103
Upright	M 1000-25 S1	184
Upright	S 110	102
Upright	M 300	69
Upright extrusion	S 108	102
Upright extrusion	S 201	104
Upright extrusion	S 202	105
Upright extrusion	S 100	102
Upright extrusion	S 208	15
Upright extrusion	S 380	15
Upright extrusion	S 308	106
Upright extrusion	S 408	109
Upright extrusion	S 850	110
Upright extrusion	S 855	110
Upright extrusion	S 209	15
Upright extrusion 135°	S 203	106
Upright extrusion 45°	S 302	107
Upright extrusion 60°	S 303	108
Upright extrusion 60°	S 500	111
Wall insert extrusion	S 204	242
Wall mounting plate	M 1148	299
Wall panel retainer "bottom"	M 1581	180
Wall panel retainer "bottom"	M 1571	179
Wall panel retainer "centre"	M 1577	180
Wall panel retainer "centre"	M 1567	178
Wall panel retainer "centre"	M 1568	179
Wall panel retainer "top"	M 1572	179
Wall panel retainer "top"	M 1561	178
Wall panel retainer "top"	M 1562	178
Wall panel retainer "top"	M 1563	178
Washer	Z 185	255
Wing nut set	M 1277	65
Wood Shelf	MF 125 P	169
Wood Shelf	MF 150 P	170

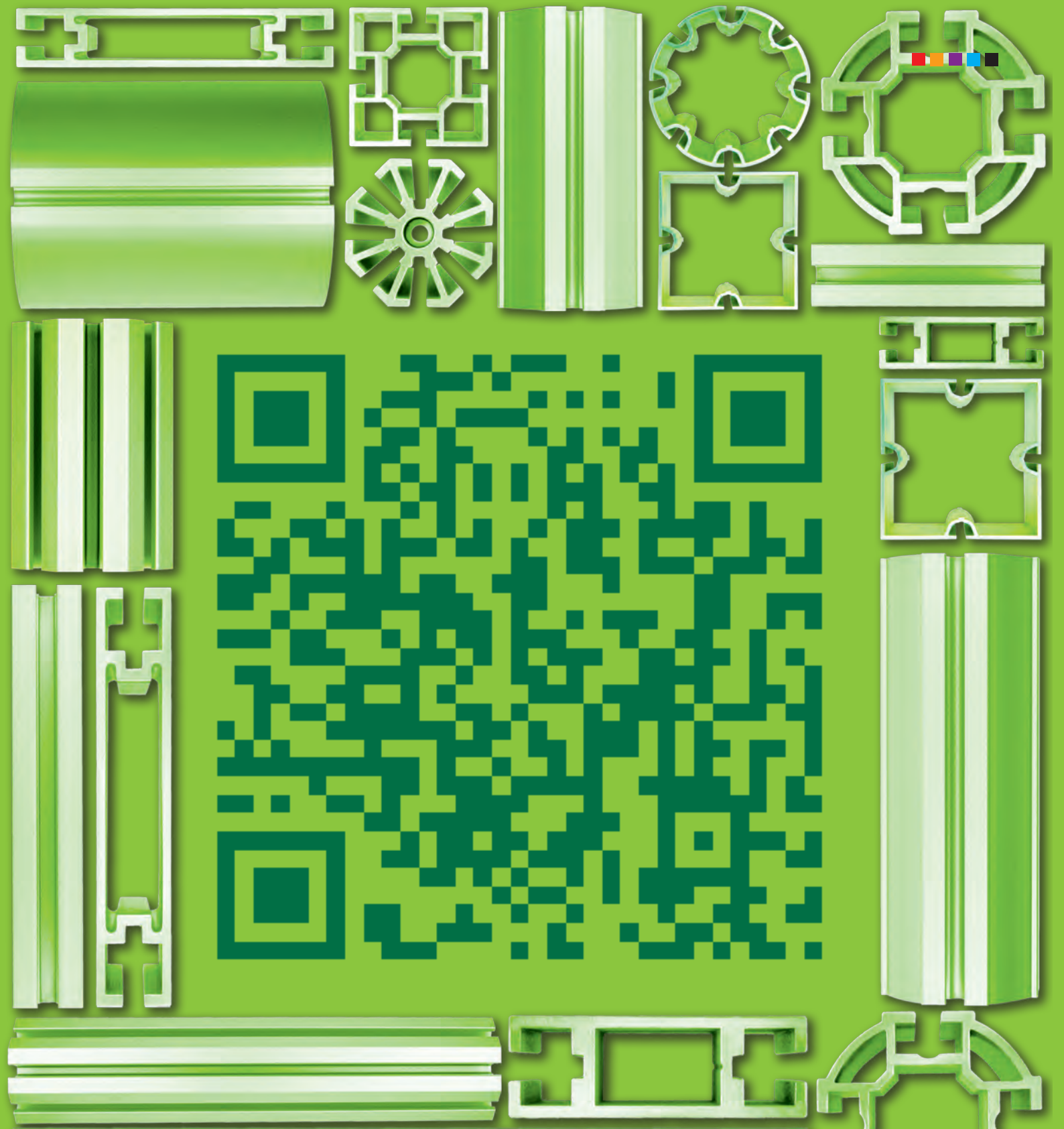

THE GREEN VALUE OF OCTANORM SYSTEM COMPONENTS

Aluminium's light weight, combined with it's durability can result in dramatic fuel and emission saving. For more information please visit www.octanorm.com/GoingGreen

exhibition systems
interior design systems
presentation systems
cleanroom systems
software and service

If you are looking for innovative system components, you only need to remember one name: OCTANORM.

> www.octanorm.com

AW 887.GB-01/2014

THE
WORLD
OF
SYSTEMS

OCTANORM 